

Swift Group

Dunswell Road
Cottingham
East Yorkshire HU16 4JX

Tel **01482 875740**

Fax **01482 840082**

email enquiry@swiftgroup.co.uk

For more information visit
www.swiftgroup.co.uk

Issued July 2012





Holiday Home Owner's Handbook



CONTENTS

| | |
|--|------------|
| Introduction | 3 |
| Warranty and After Sales | 7 |
| Siting | 11 |
| Safety | 19 |
| Heating and Cooking | 29 |
| General Care, Maintenance and Winterisation | 33 |
| Technical Information | 53 |
| Index | 102 |

INTRODUCTION

| | |
|----------------------------------|---|
| Introduction | 4 |
| Owner's Certificate | 5 |

INTRODUCTION

Thank you for deciding to buy a new Swift caravan holiday home.

We are sure you and your family will enjoy many happy hours of comfort and relaxation and hope the information in this handbook will improve your enjoyment. It has been designed to give you a general guide to the care, safe use and maintenance of your caravan holiday home and help protect your investment.

The information contained will answer most of your queries, but if there are any aspects which are not covered please consult your park owner, distributor or dealer for further advice. A dedicated customer care team supports them and, together, we aim to give you many years of pleasure.

Please note that caravan holiday homes are designed for holiday accommodation and not for permanent residential all year round use.

OWNER'S CERTIFICATE

Please complete all details on form below for reference at a later date.

| | | |
|---|-----------------|---------------|
| Manufacturer: | Swift Group Ltd | Owner's Name: |
| Model: | | Home Address: |
| Identification Marking: | SG | |
| Key Number: | | |
| CO Alarm (Date of Manufacture) | | |
| Smoke Alarm (Date of Manufacture) | | Tel No. |
| Supplied and fully inspected before delivery by: | Dealer: | Dealer Stamp: |
| | Address: | |
| | Tel No. | |

This certificate identifies your Caravan Holiday Home accurately. Please produce this whenever you require a service, repairs or when ordering additional accessories.

WARRANTY AND AFTER SALES SUPPORT

| | |
|---|----|
| Warranty | 8 |
| Aftersales Support and Service | 10 |

WARRANTY

All the illustrations and descriptive matter in this handbook are intended to give a general idea of the holiday home. Changing market and supply situations and our policy of continuous product development may prevent us from maintaining the exact specifications detailed in this handbook.

We therefore reserve the right to alter specifications as materials and conditions demand.

Your holiday home is manufactured by Swift Group Limited ("Swift"). Dealers and/or park operators are not agents of Swift and have absolutely no authority to bind the manufacturer by any express or implied undertaking or representation.

Your holiday home has a 1 year SuperSure manufacturer's warranty ("Warranty"). During the Warranty Period, subject to the conditions, terms and exclusions set out in this section of the handbook, Swift will repair (or at its option, replace) any defective parts of the holiday home. Warranty Period means 12 months from the date of transfer of a new holiday home from an approved Swift Group Dealer or Park Operator to its first owner.

Conditions

1. You must transport and site your holiday home in accordance with either Swift's recommendations or the Code of Practice for the Transportation, Siting and Commissioning of Caravan Holiday Homes. Your Dealer or Park Operator can provide you with more information this code of practice. Swift will not be liable under this warranty for any damage or defect that arises from your failure to site your holiday home in accordance with Swift's recommendations or the Code of Practice for the Transportation, Siting and Commissioning of Caravan Holiday Homes.
2. This warranty only applies to holiday homes purchased and sited in the UK.
3. You must keep your holiday home in a good state of maintenance and repair. Swift will not be liable for any defect caused by any negligence, misuse or modification of the holiday home.
4. All new holiday homes must be registered with Swift within 6 weeks of purchase as new.
5. The Holiday Home must not be used for permanent or residential use.
6. The unit must be sited correctly on a recognised holiday site pitch.
7. The cost of transporting or moving the holiday home by any means to or from the place of repair is the responsibility of the owner.
8. Swift shall not be liable under this warranty for any defect related to or arising from the following:
 - The failure of a component for reasons of fair wear and tear;
 - Damage resulting from freezing, fire, over heating or accidents (whether caused by the user or a third party);
 - Damage as a result of failure to carry out normal or specific maintenance including, but not specific too, not draining down and winterizing the Holiday home.
 - Defect due to condensation, fungus, mildew and damp (other than as a result of a failure of a permanent seal or joint).
 - Misuse of any component;
 - Normal deterioration, corrosion, intrusion of foreign or harmful bodies, lack of servicing or negligence of any person other than Swift which causes stoppage of or impairment to the function of any component of the holiday home;
 - Replacement of parts which have reached the end of their effective working life because of age and/or usage;

- Cleaning or adjustment of any assemblies;
- Cosmetic finishes to kitchen sinks, sealants, cooker tops, vanity units, shower trays;
- Routine maintenance items including lubricants, rubber gas hose, the cleaning of the heater and fridge flues, the replacement of gas jets, the resealing and/ or replacement of shower room sealant, the adjustment and lubrication of locks;
- Any breakage or failure of any windows, glass, tyres, fluorescent tubes, replacement light bulbs, spotlights, tap washers or thermocouples;
- Any failure resulting from the use of a part or component in the holiday home which is not approved by Swift.

Failure of any part or component, which is not original equipment, or a defect caused as a result of an unauthorized modification to the Holiday home.

- Swift shall not be liable under this Warranty if the holiday home has been neglected, misused, modified or used for hire or reward or if the identification marks (chassis/VIN numbers) have been removed or defaced. The holiday home will be deemed to have been neglected if it has not been maintained as stated in this handbook.

You have legal rights under UK law governing the sale of consumer goods. This Warranty does not affect your legal rights.

The name and address of the Warranty provider is:

Swift Group Limited, Dunswell Road,
Cottingham, East Yorkshire, HU16 4JX

To make a claim under this Warranty, contact the dealer or park operator which supplied your holiday home. If this is not possible then contact the Swift Group Customer Care Department on 01482 875740, or enquire on the website www.swiftgroup.co.uk

AFTERSALES SUPPORT AND SERVICE

Please note that all after sales enquiries must be directed through your supplying Dealer or Park Operator. The After Sales service at the factory is geared to supporting our Dealer/Park Operator network, as is the service provided by the appliance manufacturers.

In the interests of safety, replacement parts for an appliance must conform to the appliance manufacturer's specifications and should be fitted by them or their authorised agents.

Note: please remember to quote the chassis number when ordering any items from your Dealer/Park Operator.

SITING

| | |
|--|----|
| Craning | 12 |
| Siting | 12 |
| Supporting the chassis | 12 |
| Jacking | 13 |
| Anchors | 15 |
| Snow Loading | 16 |
| Chassis Specification | 17 |
| typical support and holding down points | 18 |

Siting

CRANING

Given the high risk involved in craning operations, the legal requirements are particularly strict. Therefore, it is recommended that when a crane is to be used for lifting a caravan holiday home, then a specialist craning contractor is employed to undertake a 'Contract Lift'.

The contract lift must be organised through a reputable company which holds adequate insurance for all their operations, including liability cover for the caravan holiday home being lifted. If a specialist craning contractor is employed to undertake a 'Contract Lift', the park/ distributor is nevertheless obliged to have in place documented craning procedures and ensure that all persons involved with the instigating or the supervision of any craning work are fully conversant with such procedures.

Procedure

Selection of Nominated Contractor: – It is strongly recommended that the following information is obtained before any work can commence:-

A copy of the Craning company's Health and Safety Policy

Detailed, technical risk assessments relevant to lifting caravans and to that specific lift (including wind loading, load spread, appropriate slinging method, etc.

A copy of method statements as to how the work will be undertaken

Copies of training records for all competent persons

Copies of all test certificates received

Copy of segregation procedures received

Signed agreement from the nominated contractor to adhere to the hiring company's Contractor Code of Conduct

Copy of Public Liability insurance (Minimum cover £5 million and in date)

SITING

Your caravan holiday home should be sited on a correctly prepared standing of suitable material, which must provide adequate support for the caravan holiday home placed upon it.

Methods of siting vary and are dependent upon the ground conditions and specific requirements set by the local authority site licence.

SUPPORTING THE CHASSIS

Holiday homes up to 12.2m long should have a minimum of twelve supports. Each chassis longitudinal should have one support either side of the axle(s) and two forward and two rearward of the axle(s).

Holiday homes over 12.2m long should have a minimum of 20 supports. Each chassis longitudinal should have one support either side of the axle(s) and three forward and three rearward of the axle(s). The jacking support points either side of the axle(s) are identified by a red label and the other support points by a yellow label. (See diagram on page 15)

It is recommended that suitable load bearing blocks are used under the jacking/support points (red labels) and adjustable axle stands as shown in Fig. 1 are used under the chassis support points (yellow labels).

Hardwood packing should be used between the load bearing blocks and the chassis to cushion the weight and reduce the transmission of vibration.

Concrete blocks should not be in direct contact with the steel chassis.

JACKING

Selection of Jack

It is essential to ensure an appropriate jack is selected for any lifting operation. All jacks must have their maximum lifting capacity (safe working load) clearly and legibly marked with a permanent label or painted sign. Care must be taken to ensure the marked lifting capacity of the jack(s) is not exceeded. The jack(s) selected should be capable of lifting more than half the weight of the caravan; the distribution of the load and the nature of the terrain should be taken into account.

Jacking Procedure

- Most jacking accidents occur when lifting on an uneven surface when the jack slips out from under the caravan holiday home. Therefore care is necessary to ensure the jack is sitting on an even surface that is capable of taking the full-imposed weight at that jacking point, as indicated by the caravan manufacturer. Spreader plates should be used on uneven and/or soft surfaces;
- **Before raising the caravan holiday home, the wheel(s) remaining on the ground should be chocked;**
- Wherever possible, consideration should be given to lifting the caravan holiday home whilst still hitched to the towing vehicle to take advantage of the additional stability this can provide;
- The jack(s) should be placed under the defined jacking point(s)
- Jacking should be undertaken, one side at a time, using an appropriately rated jack(s);
- The caravan holiday home should **not** be jacked up to its final height and then supported. Rather, the caravan holiday home should be lifted up to a height whereby the support stand is barely extended to allow the earliest possible supporting of the caravan holiday home. The jacking should be slow and gradual and the caravan holiday home should be continually supported throughout the jacking operation;
- It may be necessary to lower the caravan holiday home onto the support stands and to reposition the jack at another designated jacking point to gain more height;
- While jacking at other points, it is important to check and recheck all support stands to make sure they remain in the correct position.

Siting

PLAN TO STAY SAFE

Use the most appropriate type of jack for the job.

Before raising the caravan holiday home, make sure the wheel(s) remaining on the ground are chocked.

Where possible, leave the caravan holiday home coupled to the towing vehicle.

Make sure the jack is on a hard level surface or use robust metallic spreader plates.

Locate the designated jacking point(s) on the chassis.

Jack the caravan holiday home slowly and check continually to ensure the jack is sitting squarely on and beneath the chassis jacking point.

As soon as the tyre is clear of the ground, the supports should be put in place.

No one should be under the caravan whilst it is being lifted or lowered by means of a jack.

No part of the body should ever be under the main chassis beams of a caravan holiday home that is supported only on a jack.

Given the risks of working beneath a caravan, it is recommended that at least one other person who has been trained in how to deal with an emergency is present and able to respond to any incident. One member of the team must remain outside the underside of the caravan at all times.

Wheel Chocks

The danger of movement whilst the caravan holiday home is being raised/levelled cannot be overstated. The wheels of the caravan holiday home (those still in contact with the ground) should always be braced with wheel chocks at the front and rear. These prevent the caravan holiday home shifting forwards or backwards (the most likely direction of movement).

Better quality wheel chocks are fabricated from steel or thick aluminium and are wedge-shaped so that they can be pushed into close contact with the wheel and tyre. For a caravan holiday home, the wheel chock should be at least 150mm high.

Spreader Plates

Spreader plates are a means of distributing a load over a wider area, and must always be used under jacks or support stands where ground conditions are uncertain. It may be necessary to double up spreader plates or lay them side by side where support is

required over a large area, such as under a larger trolley jack. It is important to place jacks in the centre of any spreader plate or combination of plates.

SITING THE CARAVAN HOLIDAY HOME

Methods of siting vary, dependent upon the ground conditions and specific requirements set by the local authority site licence. The method of siting a caravan holiday home in a flood risk area must be considered carefully. In some instances, insurers impose risk management controls in order to continue their provision of flood cover.

Care is required to position the caravan holiday home squarely on the pitch. The wheels should then be chocked in front and behind to resist movement.

Where practicable, the caravan holiday home should remain securely attached to the towing vehicle until the caravan holiday home is jacked and supported.

Where this is not possible, the towing vehicle should be disconnected ensuring the jockey wheel is left in a locked position and on a firm base or spreader plate.

The towing vehicle can then be removed from the siting operational area.

All the corner steadies should be wound down in contact with the base;

The caravan holiday home should be carefully jacked up in accordance with jacking instructions.

When one side of the caravan holiday home has been raised sufficiently to enable the wheel(s) to spin freely, solid concrete blocks should be placed under the main longitudinal chassis beams either side of the axle (in four positions - see diagram on page 15). The other side of the caravan holiday home can then be raised and supported in the same way. Suitable packing material should be placed between the top of the concrete block and the underside of the chassis to cushion the weight and reduce the transmission of vibration.

Concrete blocks should not be in direct contact with the steel chassis;

The corner steadies should now be extended on either side to ensure that the caravan holiday home is stable. At this point, intermediate supports should be carefully placed between the supports either side of the chassis and the corner steadies;

A spirit level should be used to check that the caravan holiday home is absolutely level across its width. The internal floor should be used for levelling purposes across both the width and the length of the unit.

Alternatively, a spirit level can be used by placing it under the floor joists by straddling several joists at a time, repeating this

process at appropriate intervals throughout the length of the home. Levelling the caravan holiday home is one of the most important aspects of siting a caravan holiday home. Without the correct level, much time may be wasted trying to rectify what originally may be thought of as poorly fitted doors, windows or furniture. Laser levels can be used as an alternative to spirit levels for levelling caravan holiday homes;

When the caravan holiday home is levelled correctly, the intermediate heavy duty support stands underneath the chassis should be placed and adjusted under all identified support points between the supports either side of the chassis and the corner steadies. (figure 1 below illustrates the correct position)

Figure 1. Intermediate supports

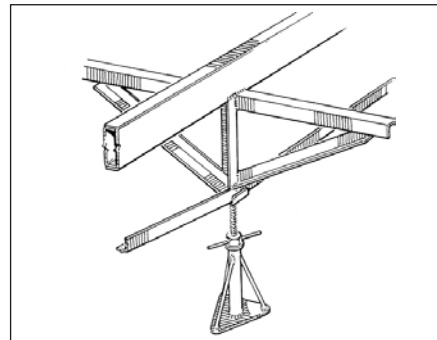

When the caravan holiday home is level in all directions, the corner steadies may be retracted into their stored position. They should not be used as additional supports and if they are to remain extended, they should be at least 6mm off the ground;

First external and then internal doors should be checked to ensure that they close and lock correctly. If there is misalignment between the door and frame, the caravan holiday home may not be level. This should be checked and adjusted as appropriate. Only minor misalignment can be corrected via the hinges and/or lock keeps;

An alignment check should be carried out four weeks after siting as settlement usually occurs. If the caravan holiday home has settled, the level should be adjusted as required. The classic signs of a caravan holiday home being out of level are doors not closing properly, locks not locking properly, cupboard doors out of line, windows binding, or floors creaking.

ANCHORS

It is good practice to anchor the caravan holiday home to the ground. Some insurance companies require that caravan holiday homes are anchored and specify minimum requirements.

The anchor points are rated at 10kN in tension. The ground anchors should be

Siting

capable of withstanding a minimum of 10kN. See Fig 2 for illustration of anchor points. Swift caravan holiday homes have specific holding down points, which are located approximately 1m from the ends of the main longitudinal chassis member at each corner (see figure 2). These anchors should not be over-tightened, which can stress the chassis. It is important to note that both the chain and turnbuckles should be suitably rated.

The preferred turnbuckle is the type which has an 'eyelet' at both ends (as opposed to hooks) and should be used with suitable 'D' shackles.

Fig 2. Anchor Points

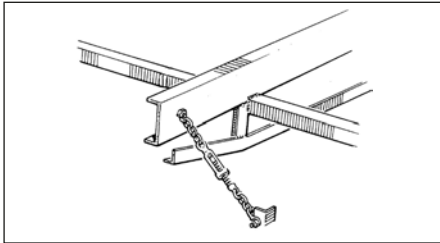

SNOW LOADING

To comply with the requirements of EN1647 Section 2 for snow loading, the following method of supporting the caravan holiday home when sited must be carried out.

The main longitudinal chassis beams should be supported by concrete blocks where cross braced on either side of the axle. An axle stand should be placed underneath the cross bracing between the concrete blocks and the corner steadies in four positions as shown on the diagram.

Great caution should be used when cleaning snow from the roof of the holiday home.

All Swift models comply with snow loading Grade B.

Guide to Snow Loading Grades

- Grade A - Only in parts of the UK
- Grade B - All of the UK + France and Germany
- Grade C - Higher European Ground
- Grade D - Scandinavia and Northern Europe

CHASSIS SPECIFICATION

- All chassis are built to CoP 501/502 specification.
- Holding down points capable of resisting 10KN – located 1000mm +/- 200mm from the end of each longitudinal.
- Corner steady - maximum extended height of 432mm Corner steadies must not be used to fully support the unit
- Jockey wheel assembly maximum load that can be applied in a static position is 150KG.
- Hitch – cast iron with 50mm ball. The maximum vertical load of the coupling head is 2.5 tonnes.

It is advisable on Auvergne models to position an axle stand on the front cross member in the position shown below to further support the chassis under the large tri-fold doors.

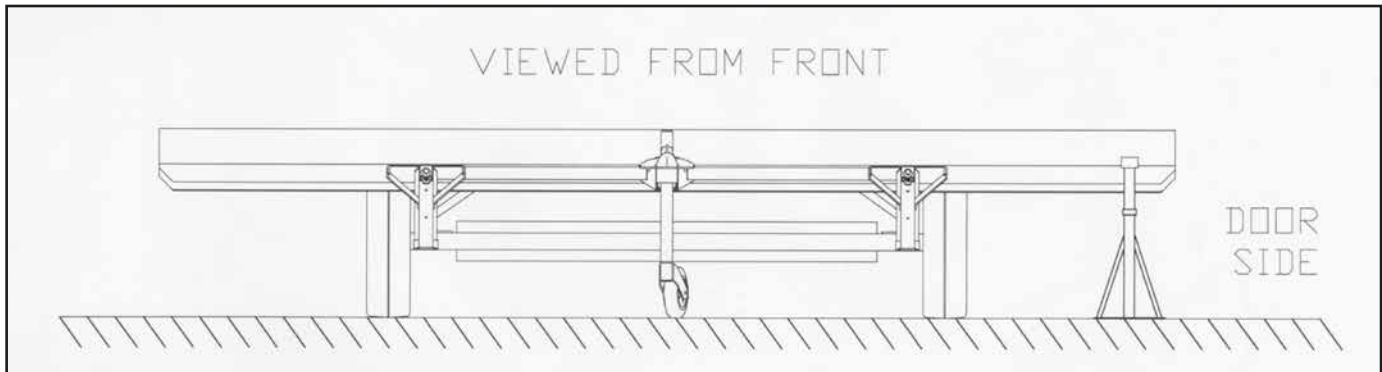

TYPICAL SUPPORT AND HOLDING DOWN POINTS

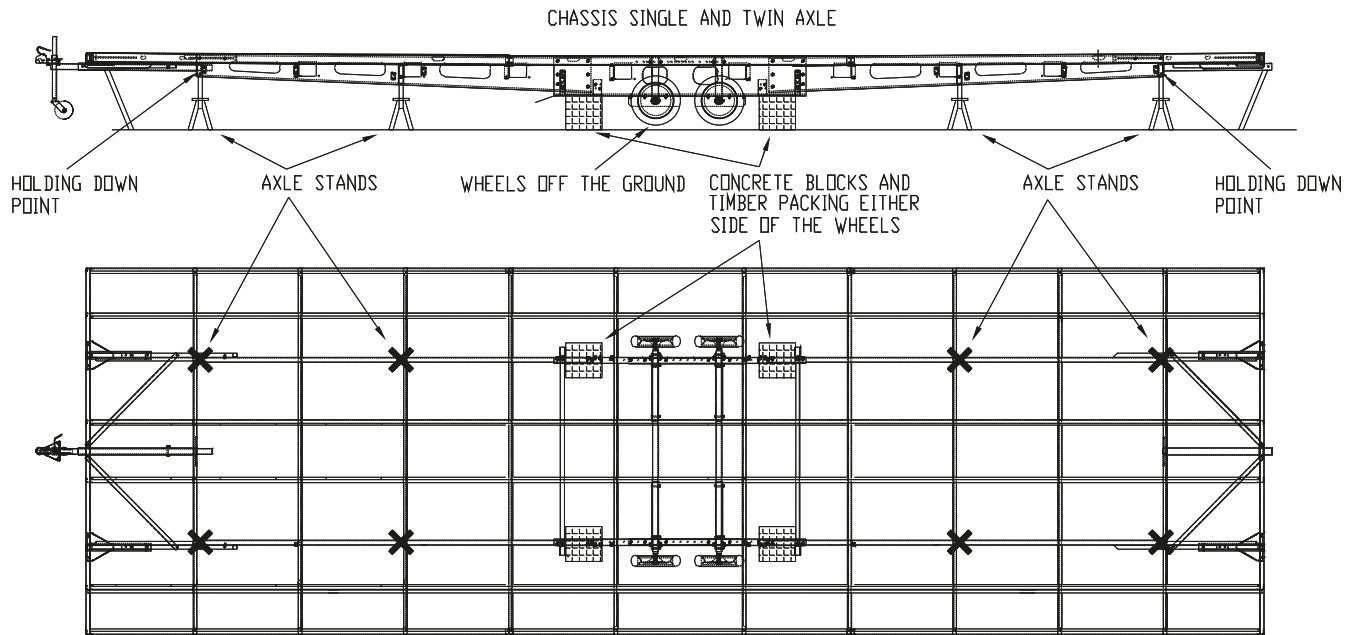

SAFETY

| | |
|--|----|
| General Advice | 20 |
| Fire Precautions | 20 |
| Smoke + CO Alarms | 21 |
| Emergency Shut Off Points | 22 |
| Safe Use of LPG | 22 |
| Safe Use of Electricity | 25 |
| Cooking | 26 |
| Ventilation | 27 |
| Pull out bed and bunks | 28 |

Safety

GENERAL SAFETY ADVICE

Ensure you and your family know the locations of all means of escape emergency exits. (Refer to the layout drawing in the technical section of this handbook for your model).

Go over the rules in the 'what to do in case of fire' section with your children and other occupants each time you have fire drills. This will help everyone remember them in case of a real emergency.

Keep a torch handy for emergencies.

Never use a naked flame.

Position a fire blanket next to the cooker

Never leave pans of oil or fat unattended.

Combustible materials should be kept clear of all heating and cooking appliances

Never use portable gas heaters or appliances.

Do not leave young children unattended in the holiday home.

Keep matches out of reach of children

Turn off all appliances and the gas bottles if leaving the holiday home unattended for long periods.

Always be aware that a fire can re-ignite, even if you think it is extinguished.

Never allow modifications to appliances, electrical and LPG systems except by a qualified person.

WARNING: Never use portable cooking or heating equipment other than electric heaters that are not of the direct radiant type, as it is a fire and asphyxiation hazard.

WARNING: Appliances such as cookers must not be used for heating.

WARNING: Provide one dry powder fire extinguisher of an approved type or complying with EN3 or ISO 7165, of at least 1kg capacity, by the main exterior door and a fire blanket next to the cooker. Familiarise yourself with the instructions on your fire extinguisher and the local fire precaution arrangements.

WARNING FIRE HAZARD: DO NOT USE THE VOID OF THE CHIMNEY BREAST FOR STORAGE THIS AREA MUST BE CLEAR AT ALL TIMES

WARNING: Always keep Venetian blind cords secured safely out of reach of small children.

FIRE PRECAUTIONS

Important: Your attention is drawn to the notice affixed inside the holiday home advising on fire precaution, ventilation and what to do in case of fire.

WHAT TO DO IN CASE OF FIRE:

- If you have made a family escape plan and practiced it with your family you have increased their chances of escaping safely. Go over the following rules with your children each time you have fire drills. This will help everyone remember them in case of a real emergency.
- Don't panic, stay calm. Your safe escape may depend on thinking clearly and remembering what you have practiced.
- Notify every member in the residence of the fire.
- Get out of the caravan as quickly as possible. Follow a planned escape route. Do not stop to collect anything or to get dressed.
- Feel the doors to see if they are hot. If they are hot, do not open them - use an alternative escape route.
- Stay close to the floor. Smoke and hot gases rise.

- Cover your nose and mouth with a cloth (wet if possible). Take short, shallow breaths.
- Keep doors and windows closed. Open them only if you have to in order to escape.
- Meet at your planned meeting place after leaving the caravan. Carry out a head count.
- Call the Fire brigade on 999 from outside your caravan. If possible use a mobile phone or call box .
- Give the address and your name.
- Turn off the gas supply valve and remove the cylinders if it is safe to do so.
- If connected to the mains electrical supply, disconnect or switch off at the pitch supply point.
- Do not use water on fat or electrical appliances.
- Never go back inside the caravan until a member of the fire service has told you it is safe to do so.

DO NOT attempt to repair your smoke alarm doing so will invalidate your warranty.

FIRE EXTINGUISHER

It is recommended that a 1kg (2lb) minimum capacity dry powder fire extinguisher is kept inside your holiday home at all times.

After using a dry powder extinguisher it is suggested that the holiday home be evacuated until the powder has settled, to avoid inhalation.

Always aim the fire extinguisher at the base of the fire not at the flames.

Never use a powder extinguisher on a pan of fat or oil, only use a fire blanket on pan fires.

CHILDREN

Do not leave children alone in the caravan in any event. Keep potentially dangerous items out of reach, as at home eg. matches, drugs, etc.

SMOKE AND CO ALARMS

Please read the user instructions provided with your caravan holiday home.

WARNING

These are safety devices provided for your protection. Please ensure that they are maintained and working correctly by following the user instructions.

The devices require regular testing and cleaning. See user instructions.

The batteries require replacing on units with replaceable batteries, or the whole unit replacing on sealed units, as soon as the low battery warning signal is activated. See user instructions supplied with your holiday home.

Safety

EMERGENCY SHUT OFF POINTS

GAS

Isolation shut off valve for each appliance:

- **Hob/Oven/Grill:** Behind the plinth at the bottom of the oven housing.
- **Central Heating Combination Boiler:** Directly beneath the boiler.
- **Gas Space Heater:** Inside the removable hatch positioned in the side of the chimney breast

WATER

- **Exterior:** At the main feed pipe stopcock for the holiday home.
- **Interior:** At the stopcock under the floor.

ELECTRICITY

- **Exterior:** Park supply box for you holiday home.

- **Interior:** At the electrical consumer unit, usually situated in the twin bedroom wardrobe.

SAFE USE OF LPG

USING CYLINDERS

What happens inside the cylinder

Color gas cylinders are specifically manufactured to store Liquefied Petroleum Gas (LPG for short) in its liquid state. The liquid turns to gas very easily and the gas fills the space above the liquid. As gas is drawn off in use, more liquid turns to gas to replace it. An external regulator connected to the supply line between the cylinder and appliance keeps the pressure of the gas constant to the appliance as the cylinder empties until there is no liquid left to turn to gas.

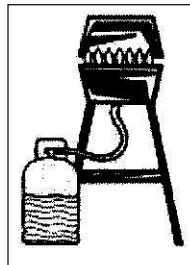

The Regulator

Except for appliances fitted with a flow controller, a suitably rated regulator of a minimum of at least 3.5kg per hour, must be

included in the connection between the cylinder and the appliance. The regulator is precisely set to control the pressure of the supply and **MUST NOT BE ADJUSTED**.

Replace after 5 years of life, or when not working properly.

Flexible Hoses

Use only marked and certified hoses to BS EN 1763 or BS3212 and which bear the year and name of the manufacturer and clips as LPG attacks and erodes natural rubber. Keep hose lengths as short as possible and less than 2 meters in length. All flexible hoses must be secured with proper hose clips. Make sure that the hoses are kept clear of 'hot spots' and inspect them from time to time. Replace any hose that shows signs of wear or damage.

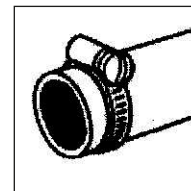

Do's and Don'ts

- **Do** treat a cylinder with care to ensure that the valve is not damaged. A damaged valve could result in a leak.
- **Do** use a cylinder upright. If used horizontally liquid gas could get into the supply pipes with serious consequences.

- **Don't** attempt to disconnect a regulator from a switch-on valve (15kg and 7kg cylinders) if the flame does not go out when the regulator switch is turned off. Leave the appliance alight and call your Gas Supplier or Park Manager.
- **Don't** subject a cylinder to heat, because the pressure inside the cylinder could build up to a point beyond the designed safety limit.
- **Don't** store or use cylinders below ground level, because LPG is heavier than air. If there is a leak, the gas will collect at low level and become dangerous in the presence of flame or a spark.
- **Don't** store or use propane cylinders (red) indoors, because propane is contained under higher pressure and should only be kept outdoors.

THE GAS SYSTEM

Your Gas System will have been connected and commissioned by a registered Gas Safe engineer engaged by your Park or Siting Agent.

Use only propane LPG at a pressure of 37mbar.

Never use appliances with a different working pressure.

Propane remains fully operational down to temperatures as low as -43 degrees. There are a variety of sizes and shapes of cylinders in which the gasses are stored. Consult your park owner who will advise you on the amount of gas needed based upon your holiday home specification and your particular family or individual requirements.

Gas Regulators

Gas cannot be supplied from a bottle without gas regulation. The connection must be by high pressure flexible hose which shall be as short as possible. The gas regulator supplies gas to the gas appliance at a constant pressure independent of gas flow.

Ensure the regulator is of the correct pressure rating for the gas appliances in your holiday home. Your dealer or gas supplier will advise you of the type of regulator required.

Regulators should be kept clean and dry and changed approximately every 5 years or earlier if not working properly.

THE REGULATOR CAPACITY SHOULD HAVE A MINIMUM RATING OF 3.5KG PER HOUR WITH A WORKING PRESSURE OF 37 Mbar. NEVER USE APPLIANCES WITH A DIFFERENT WORKING PRESSURE

Safety

Gas Inlet

The inlet connection is the start point of the holiday home's gas system. It will be found at the rear of the holiday home.

Cylinders

A gas cylinder must always be operated standing on its base. A cylinder on its side could allow liquid gas into the supply pipes with very serious consequences. Never apply heat to a cylinder; this could cause a build up of pressure beyond the design limit. Treat the cylinder with care as a damaged valve could result in a leak.

GAS SAFETY

- LPG is a heavy gas and therefore sinks to the lowest point.
- If there is insufficient ventilation a spark could result in an explosion.
- Do not store or use gas cylinders indoors, it is contained under high pressure and should only be kept outdoors and never stored below ground level.
- LPG is odourless so the manufacturers add the distinctive smell to act as a warning if a fault should occur.
- If you suspect a gas leak, extinguish all flames, turn off the gas at the bottle and ventilate the holiday home by opening doors, windows, and cupboards. Do not

operate fans, lights or other electrical apparatus. Get outside for a few minutes and consult your park operator.

- It is vitally important that you read all instructions and labels before using any appliance and keep them handy for future reference.

IF IN DOUBT ASK.

Do not place clothes or any other combustible material on, over or near any gas appliances, such as fires, cookers or water heaters. Apart from the fire hazard, their presence could affect the appliance and negate any guarantee.

Do not use appliances in any way other than their intended use. Cookers are for cooking NOT heating.

ALWAYS REMEMBER - Gas appliances that are designed, installed and used correctly, regularly serviced and properly ventilated and flued are completely safe

WARNING:- FIRE HAZARD

Never use portable cooking or heating equipment inside your holiday home, other than electrical heaters that are not a direct radiant.

GAS

- Always use a Gas Safe registered gas fitter for any work or modification to your gas system or appliances.
- Make sure that heating, cooking appliances and gas cylinders are switched off before you leave the holiday home.
- Make sure that there are no naked lights when changing the gas cylinder.
- Make regular checks of the flexible gas hose.
- Never look for a gas leak with a match or cigarette lighter. If you suspect a leak, call in a Gas Safe registered fitter who will use a safe and appropriate method of locating and repairing the leak.
- Keep everything clean, particularly the gas jets within each appliance. When not in use, keep the gas inlet protected.
- Never use additional independent gas appliances inside the holiday home
- The flue installation for all appliances should be inspected at least once a year, throughout its length, for corrosion. If any sign of corrosion is found it must be replaced immediately with the correct type and by a registered fitter. To inspect the gas flue, the engineer will remove the self tapping screws which hold the inspection panel(s) at high and/or low level.

CARBON MONOXIDE - THE FACTS

- When gas does not burn properly, poisonous carbon monoxide fumes may be produced.
- You cannot see or smell carbon monoxide fumes. They are invisible, odourless, colourless and tasteless.
- Fumes from partially burnt gas kill more people than fires and explosions from unburnt gas.
- Faulty gas appliances, poor ventilation and incorrect flues may produce carbon monoxide.
- The danger signs on gas appliances are stains, deposits of soot and excessively yellow or orange flames
- Carbon monoxide can cause drowsiness, dizziness, headaches, watering eyes, chest pains or palpitations, sickness, stomach pains or diarrhoea. Unfortunately, these are vague symptoms produced by many other causes such as influenza and food poisoning.
- You should seek medical advice if you persistently suffer from any of the symptoms listed above after being in a room where any gas burning appliance is in use, and of course have your gas installation checked by a competent installer.

- **Remember, gas appliances which are designed, installed and used correctly, regularly serviced, and properly ventilated and flued are completely safe.**

SAFE USE OF ELECTRICITY

- Always use an NICEIC registered electrician for any work or modification to your electrical system or appliances.
 - Ensure that you understand the working of all electrical switches in your holiday home.
 - Regularly check that all electrical cable terminal connections are firm and secure. Check exposed cables for wear and damage.
 - Keep spare appliance fuses handy.
- “Remember don’t touch if you don’t understand it,”**
- Always seek advice from your park manager or a qualified electrician.
 - As a general rule, all cables run vertically to the ceiling from the visible point of termination. However, you should always check with a cable finder before drilling, screwing, nailing etc.
- Please pay particular attention to this on a partition wall where there is an electrical termination point on the other side.

WIRING

The maximum current rating of your holiday home is dependant on whether the holiday home is fitted with gas and mains electric powered appliances, or mains electric powered appliances only. The maximum is usually shown as the rating of the RCD (Residual Current Device) in the consumer unit, typically 40amp or 80amp.

Further to this, the electrical supply to your holiday home may be restricted, and please check with your park manager before using additional appliances within the holiday home. In case of doubt consult the park owner or his agent.

Within the holiday home the socket outlets are wired in radial circuits using 1.5mm 3 core flexi cable, lighting is wired in radial circuits using 1.0mm 3 core flexi cable, and appliances are wired in 2.5mm flexi cable.

The Residual Current Circuit Breaker (RCCB) or Residual Current Device (RCD) serves as the main switch for your holiday home. It is also the main emergency shut off switch for your holiday home. It is a safety device designed to protect you from the possibility of shocks that could arise from a faulty power pack supply, faulty appliance or a fault on the holiday home causing the current to run to earth.

Safety

The RCD has been factory tested for correct operation. The RCD should be tested each time you switch on the mains supply and/or every month.

- With the supply connected, switch RCD to ON.
- Press test button marked 'T'.

Unit should now 'trip off'. If so, reset the system by switching on again. If the unit does not 'trip off' do not use the mains supply until the fault is corrected – consult your park owner or qualified electrician. If the unit 'trips off', other than during test, again do not attempt to use the mains supply – there is a fault which needs expert attention. In case of difficulty consult an approved electrical installation contractor. It is dangerous to attempt modifications and additions yourself. Preferably not less than once a year, the electrical installation should be inspected and tested and a report on its condition obtained as prescribed in the Regulations for Electrical Installations, published by the Institute of Electrical Engineers.

MAINS ELECTRICITY AND FAULT FINDING

Symptom:

No mains electric working in the holiday home.

- Is the RCD and miniature electric circuit breakers (MCB) switched on?
- Is the holiday home connected to park supply?
- Park supply switched on?

Symptom:

The RCD or MCBs trip out after the holiday home is switched on at the park supply.

- Disconnect appliances in holiday home and reset MCBs.



Symptom:

If the RCD and/or MCBs still trip out.

- There is a fault on the electrical circuit or the circuit is overloaded. Consult your park owner or qualified electrician before using mains supply.

Symptom:

The RCD or MCBs do not trip when tested.

- There is a fault on the electrical circuit. Do not use the mains supply until the fault is corrected. Consult your park owner or qualified electrician.

BULBS

It is important to fit the correct wattage lighting bulbs. The maximum bulb size can be found on the light fitting or lamp holder.

COOKING

GAS OVEN / GRILL / HOB

WARNING: Accessible parts may be hot when the oven, grill or hob is used. Remember, it is dangerous to use an appliance without reading the manufacturer's instructions.

Cooking Equipment - Be Safe Not Sorry

- When you are cooking, keep children away from the vicinity of the appliance.
- Keep all flammable materials (such as curtains, furnishings and tea towels) away from the appliances.
- Do not allow fat to build up in a grill pan, this creates a fire hazard.

- Do not use the oven with the door inner glass panel removed (glass oven doors only).
- Parts of the appliance may be hot during or immediately after use.
- Allow sufficient time for appliance to cool after switching off.
- Do not drape tea towels over flue vents as this creates a fire hazard.
- Be careful when opening the oven door as steam may escape from the cooking.
- Using aluminium foil on the hob or to cover the grill pan, or placing items wrapped in foil under the grill can create a fire hazard.
- Use oven gloves when removing hot food utensils from the oven or grill.
- Do not use foil to line oven shelves or grill pan, or allow it to block the oven flue, as this creates a fire hazard and hinders circulation
- When cooking heavy items, e.g. turkeys do not pull the oven shelf out with the item still on the shelf.
- If the cooker has a storage compartment below the oven, this should only be used to store oven furniture.
- Do not store any flammable materials in this compartment.
- When cooking with fat or oil, never leave unattended.
- Turn pan handles inward so they are out of reach of children and cannot be caught accidentally.
- Use pans with a flat base of minimum 100mm/4ins diameter, and a maximum 230mm/9ins diameter which are stable in use.
- Avoid using double pans, any old miss-shapen pans or any pan that is unstable when placed on a flat surface.
- Position pans over the centre of the burners.
- Glass hob lids may shatter when heated, turn off all burners and allow to cool before lowering.
- Never use the appliance for heating a room. When you have finished cooking check that all controls are in the off position.

VENTILATION

Your holiday home complies with BS EN 721. The ventilation points on your holiday home are fixed points of ventilation which are required by the European Standards.

All holiday homes have ventilation at high level and low level which have been calculated to suit the individual needs of your holiday home.

All high level ventilation is achieved by means of roof ventilators. Low level ventilation in the main living area is positioned underneath a unit in the kitchen area venting directly into the living area. Low level bedroom ventilation is positioned in the sides of the fitted wardrobes at floor level or under the bed. These round vents can be removed for cleaning if required by removing the two fixing screws.

It is advised that fixed ventilation points are checked and cleaned (if necessary) on a regular basis using a small brush and a domestic vacuum cleaner.

Additional night time ventilation is obtained by releasing the window catches and placing them in the second groove.

Note the windows are not sealed from rain in this position.

As the ventilation levels are calculated to suit each model requirements, there should be no modifications made which may result in reduced ventilation levels.

Safety

For approximate locations refer to the holiday home drawing in the technical section of the handbook.

WARNING: Under no circumstances must any ventilator be blocked or obstructed even partially.

WARNING: Care must be taken when using a Pull-out bed in close proximity to the space heater

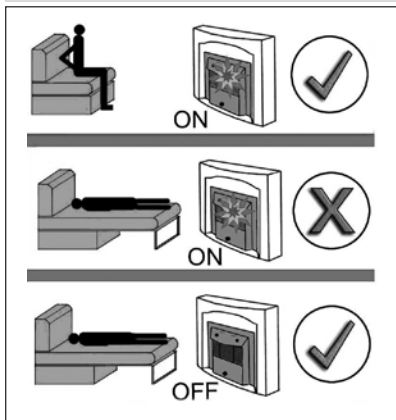

BLINDS

Where appropriate blind cord cleats are provided. Please ensure cords are safely secured out of reach of small children at all times.

PULL OUT BED

Take care when unfolding the bed as some components are spring loaded to assist the bed unfolding.

- Remove the cushions from the seat and lift up the seat base and store safely to one side.
- Unfold the bed by lifting the front edge of the bed. See diagram below.
- Unfold the bed ensuring that the legs are fully pulled out.
- Remove all bedding except for the mattress when folding the bed away.

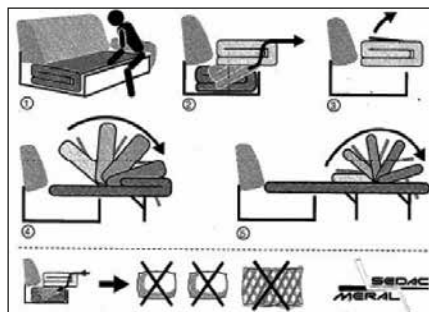

BUNK BEDS

WARNING: Use upper bunks for sleeping only, with the provided protection against fall out in position

Protection boards must not be climbed over or used to access the bunks.

WARNING: Care shall be taken against the risk of fall out when the upper bunks are in use by children especially under 6 years of age, these bunks are not suitable for use by infants without supervision.

WARNING: Bunks are designed to carry a child to a maximum of 70kg (11 stone).

TO LOWER THE BUNK

- Release the catch at the top right hand side of the bunk.
- Pull the bunk down to the horizontal position.
- Engage the catch behind the lower catch plate to prevent the bunk from lifting by itself.
- Lift the safety protection board and unfold the left hand end to provide full length fallout protection.
- Clip the ladder to the retainers on the fascia of the bunk.
- To fold up the bunk, reverse these instructions.

HEATING AND COOKING

| | |
|---|-----------|
| Central Heating and Hot Water System | 30 |
| Appliances | 31 |

Heating and Cooking

BEFORE USING APPLIANCES PLEASE READ THE USER INSTRUCTIONS SUPPLIED.

NOTE: In the interest of safety, replacement parts for an appliance must conform to the appliance manufacturer's specifications and should be fitted only by them or their authorised agent.

CENTRAL HEATING AND HOT WATER SYSTEM

PLEASE READ THE USER INSTRUCTIONS.

CAUTION: - The boiler can produce water at over 80°C when in central heating mode. If you run a hot tap when the boiler has been heating the radiators, the initial flow through the hot tap could be very hot. DO NOT PLACE YOUR HANDS under the tap or use the shower until the initial flow has passed.

The thermal grade of your holiday home is Grade 3 with central heating and double glazing & Grade 1 without central heating and / or double glazing:-

The definition of a Grade 3: A caravan holiday home, including windows, doors and roof lights in which the average thermal transmittance (U) of the elements shall not exceed 1.2 W/(m².K).

An average temperature difference of at least 35°C between inside and outside temperatures shall be achieved in lounge, dining room and kitchen, when the outside temperature is -15°C

The definition of a Grade 1: A caravan holiday home, including windows, doors and roof lights in which the average thermal transmittance (U) of the elements shall not exceed 1,7 W/(m².K).

There is no heating for this grade

Radiator valves

Thermostatic radiator valves (TRV) are fitted to all radiators except the bathroom adjacent to the boiler, to control the room temperature.

Appliances

GAS OVEN AND GRILL

Please read the user instructions provided before using the oven and grill.

GAS HOB

Please read the user instructions provided before using the hob.

COOKER HOOD

Please read the user instructions provided before operating or changing the filter.

FRIDGE/FREEZER

Please read the user instructions provided before using the fridge/freezer.

WARNING:

Like the majority of domestic fridge/freezers sold in the UK your fridge/freezer is designed to operate within an ambient temperature range of 16°C and 32°C. If the ambient temperature falls below 16°C the appliance compressor will not operate as often resulting in the temperature in the freezer compartment rising. If this is for an extended period of time there is a possibility of some of the freezer contents defrosting. If the temperature drops below 3°C the appliance will not operate at all and the freezer compartment will defrost. (Unless the ambient temperature is below -9°C). Therefore, if the holiday home is left unoccupied and without heating, and the ambient temperature within the van is likely to fall below 3°C, we would recommend that the fridge/freezer is emptied, cleaned and switched off until such time as the ambient temperature rises to within the normal operating range.

MICROWAVE OVEN (IF FITTED)

Please read the user instructions provided before using the microwave.

ELECTRICAL LOUNGE FIRE/HEATER (IF FITTED) PLEASE READ USER INSTRUCTIONS PROVIDED

WARNING: Before undertaking any maintenance or cleaning, disconnect from the power supply. Only competent persons should service/repair appliances.

NOTE:- To prevent scratching of the front screen, this appliance should be cleaned with soapy water and a damp cloth only. Due to the nature of stainless steel it picks up finger marks easily, the trim should always be cleaned with a cleaner that is suitable for stainless steel.

FOR LAMP REPLACEMENT AND FAULT FINDING PLEASE CONSULT THE USER INSTRUCTIONS.

GAS FIRE (IF FITTED)

Before igniting your fire read the user instructions.

DISHWASHER (IF FITTED)

Please read user instructions before using the dishwasher.

Heating and Cooking

GENERAL CARE AND MAINTENANCE

| | |
|---|----|
| Chassis | 34 |
| Checking the External Structure | 34 |
| Windows and Doors | 36 |
| Kitchen and Bathroom | 37 |
| Furnishings | 39 |
| Furniture | 41 |
| Security | 41 |
| Alignment and adjustment of doors | 43 |
| Entrance door and hinge adjustment | 44 |
| Hinge adjustment | 44 |
| Lock keep adjustment | 48 |
| Vinyl Flooring | 49 |
| Internal | 49 |
| Electrics | 49 |
| LPG | 50 |
| Winterisation | 51 |

General Care

CHASSIS

GALVANISED CHASSIS

The chassis is Hot Dipped Galvanised. Hot dip galvanising has been used for many years throughout the automotive industry and is widely regarded as one of the best forms of corrosion protection.

When the steel is withdrawn from the galvanising bath it has a clean, bright surface. Over a period of time this changes to a dull grey colour as the surface zinc reacts with oxygen, water and carbon dioxide in the atmosphere to form a tough, stable, protective layer.

During this time, if galvanised items are stored in damp or wet conditions, where there is little or no air movement, then the zinc will continue to react with the moisture that is present. In so doing the zinc will produce excessive amounts of zinc hydroxide. This is seen as a bulky white deposit on the surface of the galvanising and is often referred to as wet storage stain (white rust).

In the case of Leisure Accommodation Vehicles, you can help to prevent wet storage stain (white rust) occurring. You can do this by washing the chassis with clean water as soon as they are delivered. You must then allow an adequate flow of dry air to ensure that they dry off completely.

Should wet storage stain (white rust) occur on a product however, then it can sometimes be removed using a stiff bristle brush or a "Scotchbrite" pad.

Because of its post process nature "Wet Storage Stain (white rust)" is not covered under Warranty procedures.

PAINTED CHASSIS

It is imperative that as a minimum, annual inspections take place to all painted steel areas to assess any degradation of the paint system.

The finish on a caravan chassis is under constant attack from sunlight, coastal air, pollution, dust and frost. To this end it is recommended that the chassis is regularly inspected and washed as appropriate.

Maintenance may be required at more frequent intervals because of fading, chalking, chemical contamination, wear and tear, or for aesthetic or other reasons.

Mechanical damage to the paint system will result in a significant reduction in the paint durability. Hence, mechanical damage must be identified at an early stage and appropriate touch-up procedures followed to the effected areas.

Minor paint damage, such as chipping, can be touched up with approved paint, available through your dealership.

CHECKING THE EXTERNAL STRUCTURE

Inspect visually for damage to panels, gutter and other external features. Signs of damage, leakage and movement should be repaired as necessary.

SAFETY WARNING

ENSURE THAT ALL NECESSARY WORKING AT HEIGHT SAFETY PRECAUTIONS ARE IN PLACE BEFORE CLIMBING ONTO THE ROOF.

WARNING

TO AVOID DAMAGING THE ROOF USE A 15MM OR THICKER SHEET OF PLYWOOD OR SIMILAR. IT MUST BE WIDE ENOUGH TO SPAN OVER TWO ROOF SPARS WHICH ARE APPROXIMATELY 400MM CENTRES, A SHEET 1220MM X 1220MM (4'X 4') SHOULD BE SUITABLE WHEN POSITIONED CAREFULLY ON THE ROOF.

Visually inspect for damage of the roof structure, check all visible mastic seals for signs of shrinkage or cracking and re-seal where necessary.

The water system should be inspected for leaks and rectified as necessary.

BLOCKAGES

If you have a waste water or toilet blockage, the first thing to check is that the site main drainage is clear as any blockages here could back-up to your holiday home. If it is clear and you have a toilet blockage we would recommend that you call a plumber, unless you are aware of what could have caused the problem and are competent to address the problem. If it is a waste blockage, you should first check and clean out traps situated under the sink, basin and shower tray (if fitted). If you still have a blockage, then it must be in the feeder pipes to the main sewerage pipes or the main sewerage pipe. You should consult a **PLUMBER OR YOUR PARK OFFICER AT THIS STAGE** unless you are competent to do the job.

GUTTERS AND DOWNPIPES

It is important that all gutters and down pipes are kept free from obstructions and blockages. Inspect regularly.

EXTERIOR PANELS

ALUMINIUM PANELS

The aluminium exterior of your holiday home is pre-painted, oven dried aluminium sheet and is very easy to keep clean. The cleaning method recommended is to wash down with plenty of clean water and very mild detergent.

An occasional polish with a good quality wax will help obtain a high gloss finish. Under no circumstances should an abrasive or harsh cleaner be used. Stubborn marks, such as bird soiling, grease etc. can be removed by rubbing with a soft cloth dampened with White Spirit.

Aluminium panels will expand in direct sunlight as the panels heat up. This is normal and they will contract back as the temperature lowers.

WARNING: Do not use abrasive or acidic chemicals to wash your holiday home.

CANEXEL PANELS

CanExel prefinished siding is produced from wood fibre, resin, and wax fused under pressure. This engineered wood paneling is highly stable, as well as highly resistant to moisture. The finish on CanExel siding consists of five coats of baked-on paint and a sealer top coat.

Cleaning is as for aluminium panels. Small scratches and other minor damage can be repaired with the use of CanExel retouching paint. Details can be found at www.canexel.co.uk.

PVC PANELS

These panels are low maintenance, which will never need painting or preserving and with the required care and attention will stay looking good for years.

To maintain the appearance, it will be necessary to wash the panels with warm soap and water to remove surface dirt. The frequency of cleaning will depend upon the local environmental conditions. Copious amounts of soapy water should be used to avoid any chance of scratching the surface.

When wiping always use a soft cloth or sponge:

NEVER use solvent based cleaners
NEVER use abrasive cleaners.

WARNING: Do not wash your Holiday Home with a high pressure washer as these can permanently damage the exterior panels and seals of your Holiday Home

General Care

SNOW PRECAUTIONS

Great caution should be taken when cleaning snow from the roof of the holiday home.

DOORS AND WINDOWS OPERATION OF DOOR LOCKS

OPERATION OF DOOR LOCKS

To unlock the door from the outside, insert key and turn anticlockwise, pull on the handle. To lock, push the door to the closed position so that the first stage lock engages. Lift the handle upwards to engage the extra security roller locks, insert the key and turn clockwise to engage the deadlock.

OPERATION OF NIGHT VENTS (IF FITTED)

The window frame will have been fitted with a secondary keep within the rebate. You can



Fully closed



Night vent position

close the handle to locate the spur inside this keep, which will lock the window but allow a level of ventilation.

DOOR AND WINDOW HANDLES

Apply silicone spray and wipe off excess with a soft cloth.

Lock cylinder: Lubricate with PFTE (union part no. 9075) or similar. Apply the key flutes, insert the key and operate several times to ensure even distribution. Latch, dead bolt and roller locks. Apply petroleum jelly/Vaseline. This acts both as lubricant and water repellent.

Doors and window hinges: - No lubrication is required, smear with Vaseline to protect against water.

Window friction stays: - Protect with a mild detergent oil or a very light lubricant, use sparingly as oil does attract dirt.

RECOMMENDED MAINTENANCE

Lubricate every 6 months.

MINIMUM RECOMMENDED CLEANING INTERVALS

Monthly. Frames, door and window furniture. Wash with warm water and a mild detergent. It is important to ensure that all dirt and debris is regularly removed from the internal rebate of door and windows. Cleaning cloths should be in-bleached cellulose/cotton material. Do not use cloths containing synthetic fibres.

Six monthly: Clean with a proprietary brand of UPVC cleaner.

IMPORTANT: Make sure that you follow ALL the recommendations and cautions supplied with the product.

REPAIRS

On white profiles only, stains and scratches can be removed by sanding and polishing. Use a 320/400 grit sanding disc and polish using sisal rotary brush to bring back the surface finish.

It is important that you achieve a smooth even finish before beginning the polishing stage.

On wood grain surfaces, care should be taken when cleaning. Any white areas showing as a result of damage or cleaning can be retouched using a wood grain marker pen. If you have a breakage or a crack please contact your nearest glazier. Handle any broken glass with care and dispose of with safety of others in mind.

Do's and don'ts for UPVC products

Do

- Clean the glass regularly with a good quality liquid spray glass cleaner.
- Frequently wash down the UPVC with plenty of warm soapy water (use liquid general purpose cleaner) and wipe dry.

- Only use cleaning materials which do not impair anti-corrosion properties
- Use cream cleaner for isolated stubborn stains on white UPVC only. Apply with a damp cloth using minimal pressure.
- Ensure drainage slots are kept unblocked and free from dirt, spider's webs, etc.
- Keep all tracks clear of dust and debris in order to reduce the wear on sliding parts.
- Ensure that all gutters and their outlets are kept clear of leaves and debris to maintain efficient operation.
- Replace damaged or worn parts with original parts by an authorised specialist.

Don't

- Use cleaners on any UPVC.
- Use abrasive paste or cream
- Use excessive pressure when cleaning UPVC.
- Use high pressure or steam cleaners.
- Use any type of bleach, solvent (e.g., white spirit, methylated spirits, nail varnish remover) or adhesives.
- Use any unspecified tools.
- Use any abrasive papers, such as sandpaper.
- Use abrasives or brass cleaner on furniture: handles, door knockers, letter plates.

- Use excessive loads on the windows and doors.
- Fail to maintain the product as indicated.
- Paint or try to remove paint.
- Lean ladders against guttering.

KITCHEN AND BATHROOM

TOILET/SHOWER ROOM

THERMOSTATIC MIXER VALVE(SHOWER)



All Thermostatic Mixing Valves (TMV's) must be carefully protected against frost damage. TMV's should be removed or correctly drained down during months in which frost may occur.

The Thermostatic Mixer Valve controls accurately the temperature of water for

showering. The valves also maintain the pre-set temperatures even if the water pressure varies when other appliances are used. This significantly reduce the risk of scalding when showering.

Function

Hot and cold water entering the valve is mixed to a temperature pre-selected by the user or installer. This is achieved automatically by a thermally sensitive mechanism within the valve that proportions the amount of hot and cold water entering to produce the required blend. The mechanism then automatically compensates for any variations in supply pressures or temperatures to maintain the pre-selected temperature. In the event of cold water supply failure, the thermostatic mixing mechanism will automatically shut down the flow to prevent discharge of dangerously hot water

Operating pressure:

Dynamic pressure: - 0,5 bar min./ advisable 1 bar $\leq P \leq 5$ bar.

Static pressure 10 bar max.

Valves operating outside the above conditions of use cannot be guaranteed to operate as Type 2 valves.

The valve is designed for use as a high-pressure valve; it is tested against BS EN 1111.

General Care

If a water supply is fed by gravity then the supply pressure should be verified to ensure the conditions of use are appropriate for the valve.

ATTENTION: in order to assure the maximum efficiency of the mixer, the operating pressures (on hot and cold line) should be kept as balanced as possible and the inlet hot water must be at least 10°C above the required blend temperature.

When pressure is higher than 5 bar a pressure reducer is required to be fitted before the mixer.

DRAIN DOWN PROCEDURE

1. Close hot and cold mains feed taps.
2. To drain Thermostatic mixer:
 - Remove the shower hose from the mixer or lay the showerhead and hose in the shower tray to drain off any trapped water.
 - Turn bottom tap valve fully open
 - Turn the top thermostat valve fully clockwise to drain cold water, until water stops flowing.

Push in the red temperature set button on the top thermostat valve and turn fully anticlockwise to drain the hot water side until the water stops flowing.

Note: If after the drain down procedure the Thermostatic Mixer Tap is to be left for long

periods in cold or freezing conditions, leave the tap open and line up the ridge on the thermostat hand wheel with the letter “H” etched on the tap body.

PROTECTING YOUR THERMOSTATIC MIXING TAP

In addition to draining down the Thermostatic Mixer Tap in periods of cold and freezing conditions, to offer maximum protection it is highly recommended that the Thermostatic Mixer Tap is further protected by following the method outlined below:

First complete the drain down procedure ensuring the hot and cold feeds are isolated and fully drained.

Using an allen key, remove the mixer body from the tails by releasing the grub screws taking care not to misplace these.

The unit can then be completely drained, dried and wrapped in a soft cloth for storage away from frost until required.

The Thermostatic Mixer Tap can then be re-attached as follows;

Re-fit body to the tails and tighten the grub screws, take care not to over tighten.

Re-connect to the water supplies and check seals.

PROTECTING YOUR THERMOSTATIC MIXER VALVE (BATH)

In addition to a shower Thermostatic Mixer Tap, if the Holiday Home has a bath fitted there will be a Thermostatic Mixer Valve to regulate the water temperature to the bath, this will be accessed by removing (lifting) the lid covering the toilet system. This should be removed or correctly drained down during months in which frost may occur.



FOR INFORMATION THAT IS MORE COMPREHENSIVE REFER TO YOUR V100 TMV2 USER AND MAINTENANCE INSTRUCTION BOOKLET.

CLEANING

Your fitting has a high quality finish and should be treated with care to preserve the visible surfaces.

All surface finishes will wear if not cleaned correctly. The only safe way to clean your mixer is using soap water and a cloth. To dry use a soft cloth. Stains can be removed using

General Care

washing up liquid. All bath cleaning powders and liquids will damage the surface of your fitting even the non-scratch cleaners.

BATHROOM FITTINGS

High quality plastics are used in the construction of the shower room fittings. Never pour very hot or boiling water directly onto the basin or onto the shower tray - always add cold water first.

Plastics can be cleaned using a very mild detergent in tepid water. Never use abrasive cleaner or chemical cleaner. NB. It is important not to pour hot water directly into or onto any plastic.

Always start with cold water and add the hot to achieve the desired temperature.

The shower cubicle and sanitary ware should be cleaned with detergent and warm water. Never use abrasive cleaners.

TAPS

These fittings have a high quality finish and should be treated with care to preserve the visible surface.

All surface finishes will wear if not cleaned correctly. The only safe way to clean is using soap and water and a cloth. To dry use a dry soft cloth. Stains can be removed using washing up liquid.

Most bath cleaning powders and liquids will damage the surface of your fittings even the non-scratch cleaners

KITCHEN

The kitchen worktop, sink, drainer and cooking equipment surfaces should only be cleaned with hot soapy water, unless the appliance manufacturer says otherwise in their own literature. Do not use abrasives and particularly not wire wool. The inside of ovens should be cleaned in accordance with the instructions contained in the manufacturer's leaflet.

BRANDED APPLIANCES AND COMPONENTS

YOU SHOULD NOT USE THE APPLIANCE BEFORE READING THE MANUFACTURER'S INSTRUCTIONS.

PLEASE READ AND UNDERSTAND ALL OPERATING INSTRUCTIONS PROVIDED BY EACH MANUFACTURER BEFORE USING THEIR APPLIANCE.

Most of the appliances fitted into your holiday home have an instruction leaflet issued by the manufacturer and you will find this leaflet either with the appliance or placed inside a kitchen unit in your holiday home. If one cannot be found, please notify your park/supplier who will write to the appliance manufacturer on your

behalf or give you their name and address if you wish to make contact with them.

FURNISHINGS

UPHOLSTERY CARE

Cleaning

Dust, dirt and grit should be removed frequently as this will affect the durability and colour of the fabric. Please vacuum and brush your furniture frequently.

Spills and stains

Always deal with stains immediately. In the first instance remove excess with a soft absorbent cloth or white paper tissue. Cleaning instructions will vary according to the type of fabric you have selected.

If the stain cannot be removed with this method then professional cleaning will be required.

IMPALA (MODEL SPECIFIC)

General dirt and stains

1. Firstly, excess liquid should be blotted with an absorbent paper or cloth so as to remove most of the liquid from the surface.
2. The easiest way to clean is using a wet wipe or using a clean white cloth dampened with plain water. Gently rub the

General Care

area of stain using small circular motions. Do not soak the fabric in the solution as excessive soaking can cause damage. More persistent stains may need a solution of 95% water and roughly 5% soap (a gently washing up liquid id recommended).

3. Allow the cleaned area to dry completely and then gently brush or vacuum with a soft brush the area that was cleaned using strokes in the direction of the pile of the fabric.
4. More persistent stains may need a second treatment after allowing the fabric to dry. Stains of ballpoint pen, grease etc may not come out easily using the above treatment and cleaning with a diluted solution of ISOPROPYL ALCOHOL using a white cloth will then usually help.

Washing (loose covers)

Loose covers made from Impala can be washed in the washing machine at a maximum temperature of 40°C using neutral detergents only.

- Do not use bleach
- Avoid drying in the sun
- We do not recommend dry cleaning
- We recommend tumble -drying
- Iron only on the rear side of the fabric at a maximum temperature of 110°C

- After ironing freshen up the fabric by using a soft brush

| Staining agents | Clean water | 95% water / 5% Washing up liquid | Diluted IPA Alcohol | Wet wipes |
|-----------------|-------------|----------------------------------|---------------------|-----------|
| Black ink | | • | • | |
| Blue ink | | | • | |
| Marker pen | | | • | • |
| Coffee | | | • | • |
| Tea | | | • | • |
| Red Wine | | | | • |
| Soft drinks | • | • | • | • |
| Milk | • | • | • | • |
| Ketchup | | | • | • |
| Mustard | | | • | |

| | | | | |
|---------------|---|---|---|---|
| Steak sauce | | • | | |
| Soy sauce | | | | • |
| Mayonnaise | • | • | • | • |
| Butter | | | | • |
| Salad Oil | | | | • |
| Chocolate | | | | • |
| Make-up | | | • | • |
| Face cream | • | • | • | • |
| Suntan Oil | | • | • | • |
| Suntan Lotion | | | | • |
| Lipstick | | | • | |
| Urine | | | | • |
| Shoe Polish | | | • | |
| Engine Grease | | | • | |

Cleaning code W: Clean only with water based shampoo or non solvent upholstery cleaner.

Disclaimer

Impala fabric resists most household stains. Whilst Impala fabric is resistant to and drastically reduces household stains it comes in contact with, it may not be resistant to all liquids, chemicals or other materials whether containing toxic substances or otherwise and in particular the fabric is not resistant to bleaches, acids or other liquids or materials containing destructive or toxic substances. We therefore cannot accept any responsibility for misuse of Impala fabric by allowing such liquids, materials or substances coming into contact with it.

Spills and stains

Always deal with stains immediately. In the first instance remove excess with a soft absorbent cloth or white paper tissue. Cleaning instructions will vary according to the type of fabric you have selected.

Creasing

All fabrics are likely to crease, particularly on the arms and cushions. This is not a fault, but a natural feature, and will not affect the fabric's wearing qualities.

We strongly advise against washing any fabric, if in doubt, consult professional cleaning specialists.

Heat and light

Never leave your furniture in direct contact with or too close to a heat source, e.g. a space heater. Avoid standing the furniture permanently in direct sunlight as the fabric colour may fade.

CARPET

Any proprietary carpet cleaner may be used, but it is recommended that you do not use excessive amounts of water.

VINYL FLOOR COVERING

Proper care of your floor prevents damage, extends its life and keeps it looking new for years.

Always vacuum or dust hard floor surfaces before mopping. Vinyl floors generally require only warm water for cleaning

FURNITURE

Use a damp cloth to remove finger marks, etc. or an all-purpose spray cleaner or a good quality furniture oil or abrasive cleaners.

It is recommended that cupboard catches, stays, sliding bolts and hinges are kept clean and lightly oiled or smeared with petroleum jelly.

SECURITY

PROTECTING YOUR HOLIDAY HOME AND POSSESSIONS

Windows and doors

Always close and lock windows and doors when leaving your holiday home, even if only for a few minutes. Consider fitting additional locks wherever necessary; ask your park/distributor/dealer for details on security locks.

It is very important, however, that any additional locks fitted to designated escape routes (i.e. door(s) and windows) are immobilised during occupation so that your escape remains unhindered.

Gas Cylinders

Keep them chained together and fastened to the substructure of your holiday home. Always use a good quality padlock.

Lights and alarms

Many devices, both battery powered and electrical, are available to the DIY enthusiast. A light inside your holiday home at night suggests it is occupied. Electricity triggered to turn on as darkness falls or battery operated with a time switch, the light will help deter thieves. Ask your park/distributor/dealer for details on electrical intruder alarms.

Marking your property with your postcode and house number would help the police identify

General Care

the owners of stolen goods. Advertising the fact that your property is so identified may act as a deterrent. Property can be marked by etching, die-stamping, branding, engraving or by using a security marker pen.

Organise yourselves on the holiday home park so that everyone keeps an eye open for strangers or anything suspicious.

Report any unusual activity to the park manager or the police.

Holiday homes on parks are vulnerable not only in summer but also in winter.

When your holiday home is left unattended for long periods, take any extra precautions and remove any items that are valuable or portable.

For free crime prevention advice about securing your holiday home, protecting your valuables or property marking either at home or whilst on park, contact the Crime Prevention Officer through your local police station.

ALIGNMENT AND ADJUSTMENT OF DOORS

If the entrance door becomes misaligned the hinges can be adjusted to bring the door back into alignment. The lock keep can also be adjusted to ensure that the lock engages correctly.

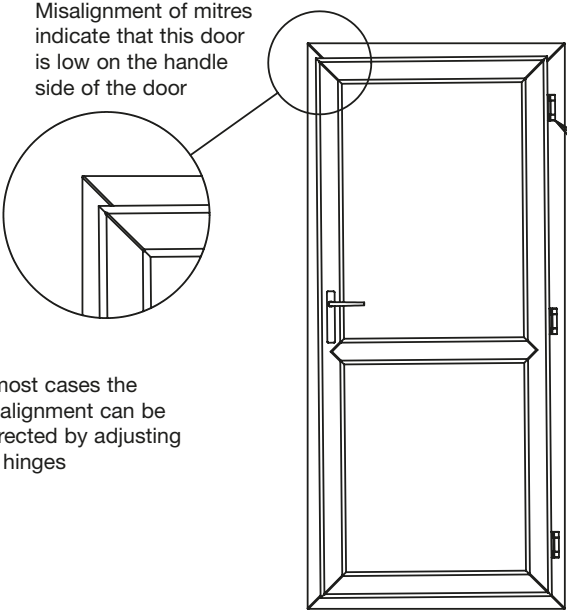
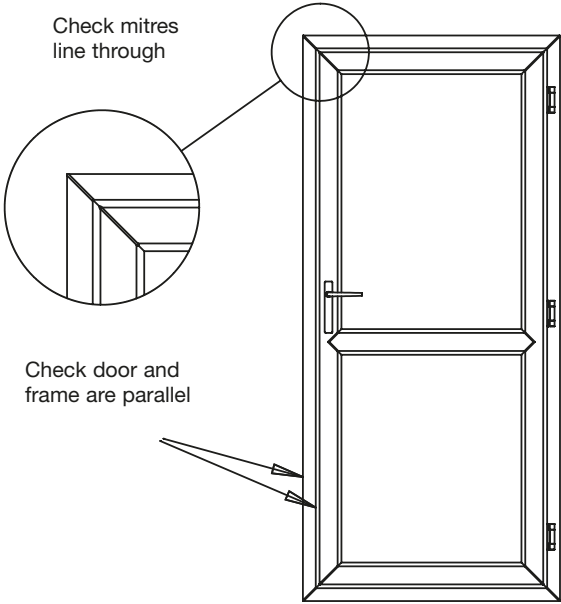

In most cases the misalignment can be corrected by adjusting the hinges

General Care

ENTRANCE DOOR HINGE AND LOCK ADJUSTMENT

If the entrance door becomes misaligned the hinges can be adjusted to bring the door back into alignment the lock keep can also be adjusted to ensure the lock engages correctly.

HINGE ADJUSTMENT

- Open the hinge covers
- Loosen the fixing screws
- Adjust the door laterally using a 5mm Alan Key
- Adjust the height of the door using a 4mm Alan key
- When the door is in the desired position tighten the fixing screws and close the covers ensuring that they are snapped shut.



Hinge in the supplied position



To adjust the door vent horizontally (left to right).
Open the door and push in the plastic clip.



This will release the hinge cover.

Adjustment available

Height (from lowest Position) +7mm
Compression (from mid position) +/- 1.75mm
Lateral +/- 5mm



Pull back the cover

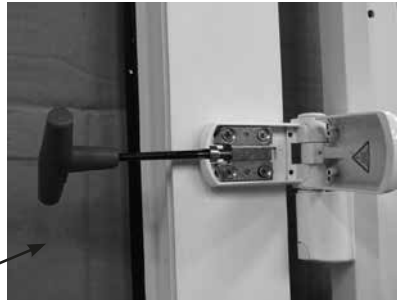

Insert 5mm A/F Alan key and turn to move the vent left or right. This will increase or decrease the clearance between the door vents and the keep. If the screw is difficult to turn it may be necessary to loosen the fixing screws. They should be tightened after the required adjustment has been made.



Adjusting the hinge as shown will correct this clearance.

General Care



To adjust the door vent compression and height within the frame unclip the cap as shown.



This bolt is used to adjust height and compression.

Insert 4mm A/F Alan key to adjust the vent height within the frame and the vent to frame compression.

As the Alan key is turned clockwise clicks are felt and the vent will rise. When the correct height has been reached the compression should be adjusted left or right clicks. The compression gap should be set at 3mm. To lower the vent turn anti clockwise and repeat the steps.

IMPORTANT: Adjusting the hinges will not compensate for a door aperture and frame that are out of square. If The Diagonal measurements shown vary by more than 5mm or the width measurements vary the Holiday Home should be levelled or the frame installation corrected. The hinges can then be used to fine tune the door operation. Any adjustment should normally be made to all hinges; otherwise the door vent could become twisted.

Diagonal Measurement

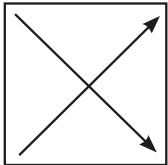

Width Measurements should be equal

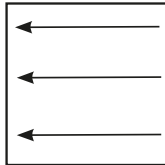

General Care

LOCK KEEP ADJUSTMENT

The Lockmaster 3 Deadlock System as illustrated to the left is a new locking mechanism developed specifically for the leisure home market. Each of the deadlocks and the latch have +20mm and -20mm vertical movement to aid locking during manufacture, transport and siting. In addition, both the top and bottom keeps and the centre latch have +2mm and -2mm of lateral adjustment to aid site fitting

To adjust the latch and keep plates use a No 2 Phillips screwdriver to release the adjustment screws and move the plate to as required. Please note that the plate and body of the keep assembly have serrations to help them lock together upon tightening of the screws

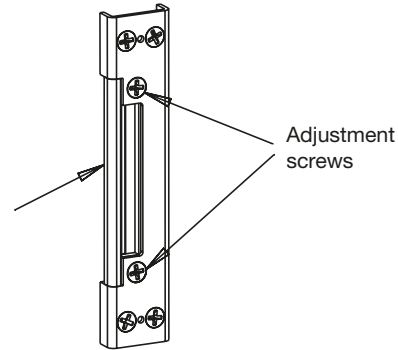
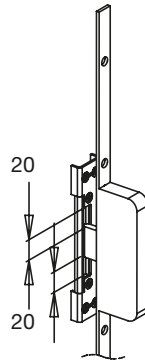

Extent of travel

Normal setting

+2mm setting

-2mm setting

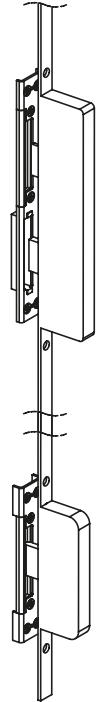
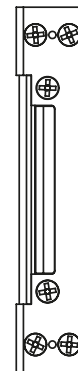

VINYL FLOORING

Vinyl flooring risk being stained by in-ground dirt if they are not cleaned regularly.

- Avoid using waxes or polishing products
- Do not use rubber protectors on the feet of chairs and furniture. Use plastic protectors instead.
- Put rigid floor protectors beneath the feet of heavy pieces of furniture to prevent the formation of permanent indentations.
- Some materials or colourants such as tar, grease, oil, dyes, waxes, ballpoint or marker inks etc. may under certain conditions migrate into the wear layer and cause indelible stains.
- Natural or intense artificial light causes a whitening effect on all floor coverings. This phenomenon becomes visible in comparison to those areas covered by rugs or furniture, which appear yellower. This yellow effect disappears after a few weeks when these areas are once again exposed to light and the whitening effect appears.

The use of a doormat without a rubber backing is recommended for doorways leading to the exterior, in order to protect the surface of the floor covering from grit and abrasive particles brought in on the soles of people's shoes.

REGULAR MAINTENANCE

Daily cleaning: using soft dry broom or vacuum cleaner.

Weekly cleaning: using neutral detergent in water with fringed mop or floor cloth.

INTERNAL

INTERNAL WALLS

All internal walls with an external side should be visually checked for damp and repaired as necessary.

SURFACE PROTECTION

Never use a knife or sharp instrument directly on worktops or unit surfaces.

BUNKS

NOTE: - IF UPPER BUNKS ARE FITTED, CARE SHALL BE TAKEN AGAINST THE RISK OF FALLING OUT. UPPER BUNKS ARE NOT SUITABLE FOR CHILDREN UNDER 6 YEARS OF AGE WITHOUT SUPERVISION. ALWAYS ENSURE THAT THE FALL OUT PROTECTION IS IN PLACE WHEN THE BUNK IS IN USE. SEE BUNKS IN THE SAFETY SECTION.

DO NOT USE THE PROTECTION BOARDS AS A MEANS TO ACCESS THE BUNK.

ELECTRICS

The electrical supply to your holiday home on some holiday parks is restricted. Please check with you park manager before using additional appliances within your holiday home. In case of doubt consult the park owner or his agent.

The Residual Current Circuit Breaker (RCCB) or Residual Current Device (RCD) serves as the main switch for your holiday home. It is also the main emergency shut off switch for your holiday home. It is a safety device designed to protect you from the possibility of shocks that could arise from a faulty power pack supply, faulty appliance or a fault on the holiday home causing the current to run to earth.

The RCD has been factory tested for correct operation. The RCD should be tested each time you switch on the mains supply and/ or every month.

- With the supply connected, switch RCD to ON.
- Press test button marked 'T'.

Periodic testing and inspection of the electrical system should be carried out as described on page 35.

General Care

LPG

The LPG installation and LPG appliances in your holiday home should be checked annually by a Gas Safe registered operative. Contact your holiday home park or Gas Safe on 0800 408 550 for a list of recommended

CHANGING GAS CYLINDERS

The following procedure should be adopted.

1. Extinguish any fire, flame or source of ignition (including cigarettes, pipes and pilot lights) before changing gas cylinders.
2. Ensure that the gas cylinder valve(s) is/are closed before disconnecting any empty cylinder or before removing the plastic cap or plug on the outlet connection of the replacement cylinder (note: Left hand thread).
3. Ensure that the replacement gas cylinder is the correct one for the installation.

Make firm gas tight joints. Any leaking vapour will smell. If a leak is suspected after changing gas cylinders and opening valve, test by brushing with soapy water around the joints. Bubbles will form if vapour is leaking.

Flexible hoses should be regularly inspected and replaced when signs of cracking or other deterioration appears. After replacement, ensure that the ends are well

secured and gas tight.

NEVER USE A NAKED FLAME WHEN CHECKING FOR LEAKS.

Gas cylinder valves are of various designs depending on the type of cylinder and the use for which it is intended and it is essential that the correct pressure regulator with the correct pressure setting and capacity for the installation is used in accordance with the manufacturers instructions.

In the case of a connection on a pressure regulator or gas appliance which relies upon a sealing washer(s) to maintain a gas tight joint, it is essential to check that the washer is present, sound and correctly positioned prior to making the connection. Where the connection relies on a metal seating or bull nose connection to obtain a gas tight joint it is essential that the mating surfaces are clean and undamaged. In no case should a damaged valve or connection be used.

Where connections are designed to be tightened with a spanner it is essential that a spanner of the correct size is used and that the union is firmly tightened (hand tightness is not sufficient). When self-sealing valves are incorporated in a gas cylinder, connections should be made in accordance with the manufacturer's instructions and tools should not be used.

GAS LEAKS

- (a) If a gas leak is suspected, close the gas cylinder valve or other valve at the inlet to the holiday home. Do not operate electrical switches. Open all doors and windows to disperse any gas escape.
- (b) The strong unpleasant smell of LPG will enable the general area of the leak to be detected. Check that gas is not escaping from an unlit appliance. In the case of a leak, close cylinder valve(s) and call a competent installer to rectify the fault.

If a leaking gas cylinder cannot be stopped, remove the cylinder to a safe place in the open air in an upright position away from drains and any source of ignition.

NEVER BLOCK VENTILATION GRILLS OR GAS DROP HOLES.

ALL APPLIANCES ARE FITTED IN ACCORDANCE WITH SPECIFICATION LAID DOWN BY EACH MANUFACTURER AND THEY HAVE UNDERTAKEN THEIR OWN INSPECTION OF INSTALLATION AND GIVEN THEIR APPROVALS.

MOST OF THE BRANDED APPLIANCES CARRY THEIR OWN WARRANTY AND AFTER SALES SUPPORT. IN THE EVENT OF EITHER BEING REQUIRED, PLEASE FOLLOW THE DIRECTIONS OF THE WARRANTY OR CONSULT YOUR OWN SUPPLYING DEALER.

SURFACES OF APPLIANCES BECOME HOT IN USE. ANY GUARDS PROVIDED MAY NOT GIVE FULL PROTECTION TO THE YOUNG OR ELDERLY.

WINTERISATION

The following items are the procedures for preparing your holiday home for winter storage. Virtually all apply whenever the unit is to be unoccupied for any long period when frosts can be expected.

- (a) Turn off LP gas supply at the cylinder and remove regulator and hose for storage inside. Ensure that the open gas inlet is protected against entry of dirt or insects.
- (b) Turn off mains water stop tap.
- (c) Open, drain off fresh water, outlets on the underside of the holiday home. Always under the central heating boiler/water heater, red and blue pipes NOT white. **Do not drain the central heating if fitted.**
- (d) Open all hot and cold taps.
- (e) Drain off the water heater and domestic water part of the water boiler as per the user instructions for the water heater / boiler supplied with the holiday home.
- (f) Thermostatic Mixer Valves require full protection from frost, they should be removed or drained correctly. Refer to the Thermostatic Mixer Valve instructions in the Kitchen and Bathroom section of this Handbook
- (g) Flush all toilets.
- (h) When all water is drained, close the drain off outlets and all the hot and cold taps.
- (i) Fridge / Freezer
 1. Turn the fridge off and allow to defrost. Clean the inside of the fridge / freezer
 2. Prop the fridge / freezer door open, and the internal freezer door if applicable for ventilation.
 3. If a fridge freezer with icemaker and water filter facilities is fitted, draining down and removal of the filter is recommended to

prevent frost damage to the filter during cold and freezing conditions.

The filter water pipes are connected to the filter with push fit water pipe fittings.

With a flat bladed screwdriver or similar blunt instrument, carefully depress the water pipe fitting collar as shown in Fig.1. Take care not to score the filter pipe as this may prevent a water tight seal when the filter is reconnected. Holding the collar tight to the fitting, carefully remove the filter.



Fig.1



Fig.2

(j) If a dish washer or washing machine is fitted it should be protected from frost damage by carrying out the following instructions:-

1. Remove electrical power to the dishwasher.
2. Turn off the water supply and disconnect the water inlet pipes from the water valves.
3. Drain water from the inlet pipes and water valves. (Use a pan to catch the water).
4. Reconnect the water inlet pipes to the water valves.

General Care

NOTE: When returning your holiday home simply reverse the procedure above. Taking these simple precautions will help to protect and maintain the efficiency of the system.

- 5 Dish washers only - Remove the filter in the tub at the bottom and use a sponge to soak up water in the sump.
- 6 Washing machines only - Drain the water from the pump by removing the filter. See washing machine instructions for how to do this.
- (k) Pour anti-freeze or common salt into the WC pan and also the sink, basin and shower waste traps. Avoid these substances coming into contact with metallic surfaces such as stainless steel sinks or waste outlet and remove any spillage. We recommend the use of a small funnel.
- (l) Switch off and unplug all electrical appliances (including TV Aerial plug). Turn mains control switch to off position.
- (m) Remove all food. Thoroughly vacuum all carpets and vinyl to remove any traces of food.
- (n) Empty the vacuum and or fit a clean bag.
- (o) The kitchen sink should be free of all particles and left clean.
- (p) Carry out a full lubrication schedule (i.e. locks, hinges, jockey wheel).
- (q) Clear gutters and fall pipes to prevent debris blocking the system.
- (r) Wash and polish exterior paintwork.
- (s) Close and secure roof light (where fitted) and all windows making sure no curtains are trapped but are hanging free.
- (t) Preferably, soft furnishings should be removed and stored in ideal conditions, or, if they are to remain within the unit, it is advisable to place cushions and mattresses separately on end or edge to allow a free movement of air around them.
- (u) Secure exterior windows. Many people leave bowls of water-absorbing crystals or common salt as a means of withdrawing moisture from the air. No moisture means no mildew and damp, so the practice is worthwhile.
- (v) Ensure all fixed ventilation points (high and low) are clear from debris and obstructions.

CENTRAL HEATING: Do not drain off the radiator system, it is a sealed system protected by an anti-freeze solution.

TECHNICAL INFORMATION

| | |
|--|-----------|
| External Dimensions | 54 |
| Model Names, Berths and Bed Sizes..... | 56 |
| General Layouts & Ventilation and Emergency Exits | 58 |
| Plumbing (Water System) | 89 |
| Plumbing (Heating System) | 90 |
| Electrical schematics..... | 91 |

Technical Info

EXTERNAL DIMENSIONS

| Model | L1 | L2 | L3 | L4 | W1 | W2 | H1 |
|-------------------------|-----------------|-----------------|-----------------|-----------------|----------------|---------------|----------------|
| Soleil 28x10-2 | 9.25m (30'4") | 9.05m (29'8") | N/A | 8.63m (28'4") | 3.33m (10'11") | 3.05m (10'0") | 3.29m (10'10") |
| Soleil 32x10-2 | 10.39m (34'1") | 10.18m (33'5") | N/A | 9.77m (32'1") | 3.33m (10'11") | 3.05m (10'0") | 3.29m (10'10") |
| Soleil 35x10-3 | 11.55m (37'11") | 11.34m (37'2") | N/A | 10.93m (35'10") | 3.33m (10'11") | 3.05m (10'0") | 3.29m (10'10") |
| Soleil 28x12-2 | 9.25m (30'4") | 9.05m (29'8") | N/A | 8.63m (28'4") | 3.94m (12'11") | 3.66m (12'0") | 3.41m (11'2") |
| Soleil 32x12-2 | 10.39m (34'1") | 10.18m (33'5") | N/A | 9.77m (32'1") | 3.94m (12'11") | 3.66m (12'0") | 3.41m (11'2") |
| Soleil 35x12-2 | 11.55m (37'11") | 11.34m (37'2") | N/A | 10.93m (35'10") | 3.94m (12'11") | 3.66m (12'0") | 3.41m (11'2") |
| Soleil 35x12-3 | 11.55m (37'11") | 11.34m (37'2") | N/A | 10.93m (35'10") | 3.94m (12'11") | 3.66m (12'0") | 3.41m (11'2") |
| Burgundy 28x10-2 | 9.25m (30'4") | 9.05m (29'8") | 8.87m (29'1") | 8.63m (28'4") | 3.33m (10'11") | 3.05m (10'0") | 3.29m (10'10") |
| Burgundy 32x10-2 | 10.39m (34'1") | 10.18m (33'5") | 9.97m (32'8") | 9.77m (32'1") | 3.33m (10'11") | 3.05m (10'0") | 3.29m (10'10") |
| Burgundy 35x10-3 | 11.55m (37'11") | 11.34m (37'2") | 11.18m (36'8") | 10.93m (35'10") | 3.33m (10'11") | 3.05m (10'0") | 3.29m (10'10") |
| Burgundy 28x12-2 | 9.25m (30'4") | 9.05m (29'8") | 8.87m (29'1") | 8.63m (28'4") | 3.94m (12'11") | 3.66m (12'0") | 3.41m (11'2") |
| Burgundy 32x12-2 | 10.39m (34'1") | 10.18m (33'5") | 10.02m (32'11") | 9.77m (32'1") | 3.94m (12'11") | 3.66m (12'0") | 3.41m (11'2") |
| Burgundy 35x12-2 | 11.55m (37'11") | 11.34m (37'2") | 11.18m (36'8") | 10.93m (35'10") | 3.94m (12'11") | 3.66m (12'0") | 3.41m (11'2") |
| Burgundy 35x12-3 | 11.55m (37'11") | 11.34m (37'2") | 11.18m (36'8") | 10.93m (35'10") | 3.94m (12'11") | 3.66m (12'0") | 3.41m (11'2") |
| Bordeaux 33x12-2 | 10.65m (34'11") | 10.45m (34'3") | 10.09m (33'1") | 10.09m (33'1") | 3.94m (12'11") | 3.66m (12'0") | 3.41m (11'2") |
| Bordeaux 35x12-2 | 11.55m (37'11") | 11.34m (37'2") | 10.93m (35'10") | 10.93m (35'10") | 3.94m (12'11") | 3.66m (12'0") | 3.41m (11'2") |
| Bordeaux 38x12-2 | 12.27m (40'3") | 12.1m (39'8") | 11.75m (38'7") | 11.75m (38'7") | 3.94m (12'11") | 3.66m (12'0") | 3.41m (11'2") |
| Bordeaux 38x12-3 | 12.27m (40'3") | 12.1m (39'8") | 11.75m (38'7") | 11.75m (38'7") | 3.94m (12'11") | 3.66m (12'0") | 3.41m (11'2") |
| Moselle 35x12-2 | 12.07m (39'7") | 11.34m (37'2") | 11.08m (36'4") | 10.93m (35'10") | 3.94m (12'11") | 3.66m (12'0") | 3.41m (11'2") |
| Moselle 38x12-2 | 12.27m (40'3") | 12.1m (39'8") | 11.89m (39'0") | 11.75m (38'7") | 3.94m (12'11") | 3.66m (12'0") | 3.41m (11'2") |
| Moselle 38x12-2+Bath | 12.27m (40'3") | 12.1m (39'8") | 11.89m (39'0") | 11.75m (38'7") | 3.94m (12'11") | 3.66m (12'0") | 3.41m (11'2") |
| Moselle 38x12-3 | 12.27m (40'3") | 12.1m (39'8") | 11.89m (39'0") | 11.75m (38'7") | 3.94m (12'11") | 3.66m (12'0") | 3.41m (11'2") |
| Auvergne 38x12-2 (FL) | 12.63m (41'5") | 12.01m (39'5") | 11.75m (38'7") | 11.75m (38'7") | 4.08m (13'5") | 3.70m (12'2") | 3.35m (11'0") |
| Auvergne 38x12-2 (FK) | 12.63m (41'5") | 12.01m (39'5") | 11.75m (38'7") | 11.75m (38'7") | 4.08m (13'5") | 3.70m (12'2") | 3.35m (11'0") |
| Chamonix 36x12-2 (OL) | 12.35m (40'6") | 11.53m (37'10") | 11.16m (36'7") | 11.16m (36'7") | 3.94m (12'11") | 3.66m (12'0") | 3.41m (11'2") |
| Chamonix 39x12-2 (OL) | 13.24m (43'5") | 12.35m (40'6") | 12.05m (39'6") | 12.05m (39'6") | 3.94m (12'11") | 3.66m (12'0") | 3.41m (11'2") |
| Champagne 41x13-2 | 14.17m (46'6") | 13.00m (42'8") | 12.78m (41'11") | 12.78m (41'11") | 4.27m (14'0") | 4.03m (13'3") | 3.66m (12'0") |
| SPECIALS | | | | | | | |
| Family Retreat 38x12-3 | 12.27m (40'3") | 12.1m (39'8") | 11.75m (38'7") | 11.75m (38'7") | 3.94m (12'11") | 3.66m (12'0") | 3.41m (11'2") |
| Provence 38x12-3 | 12.27m (40'3") | 12.1m (39'8") | 11.75m (38'7") | 11.75m (38'7") | 3.94m (12'11") | 3.66m (12'0") | 3.41m (11'2") |
| Serenity 38x12-3 | 12.27m (40'3") | 12.1m (39'8") | 11.75m (38'7") | 11.75m (38'7") | 3.94m (12'11") | 3.66m (12'0") | 3.41m (11'2") |
| Coastal Retreat 38x12-2 | 12.85m (42'2") | 11.85m (38'11") | 10.09m (33'1") | 10.09m (33'1") | 3.94m (12'11") | 3.66m (12'0") | 3.41m (11'2") |
| Woodland Escape 38x12-2 | 12.85m (42'2") | 11.85m (38'11") | 10.09m (33'1") | 10.09m (33'1") | 3.94m (12'11") | 3.66m (12'0") | 3.41m (11'2") |

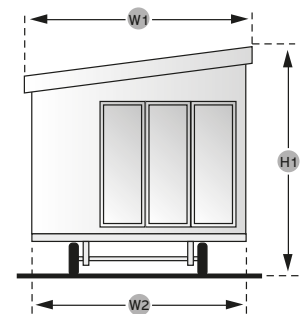
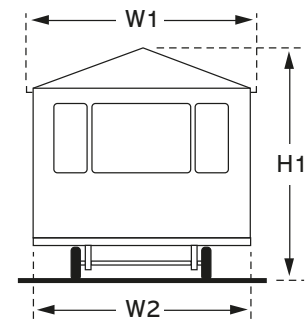
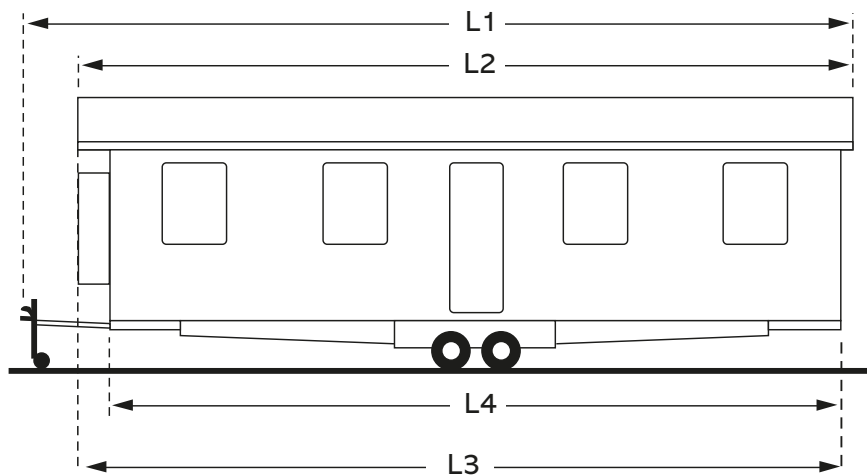

Auvergne profile

Technical Info

MODEL NAMES, BERTHS AND BED SIZES

| Model | Berths | Double | Twin | Rear Twin | Sofa Bed |
|------------------|------------|------------------------|--|------------------------|-------------------------|
| Burgundy 28x10-2 | 4 (Plus 2) | 1.91x1.37m (6'3"x4'6") | 1.83x0.61m (6'0"x2'0") / 1.76x0.61m (5'9"x2'0") | N/A | 1.80x1.12m (5'11"x3'8") |
| Burgundy 32x10-2 | 4 (Plus 2) | 1.91x1.37m (6'3"x4'6") | 1.83x0.69m (6'0"x2'3") / 1.76x0.69m (5'9"x2'3") | N/A | 1.80x1.12m (5'11"x3'8") |
| Burgundy 35x10-3 | 6 (Plus 2) | 1.91x1.37m (6'3"x4'6") | 1.83x0.61m (6'0"x2'0") / 1.76x0.61m (5'9"x2'0") | 1.83x0.61m (6'0"x2'0") | 1.80x1.12m (5'11"x3'8") |
| Burgundy 28x12-2 | 4 (Plus 2) | 1.91x1.37m (6'3"x4'6") | 1.83x0.69m (6'0"x2'3") / 1.76x0.69m (5'9"x2'3") | N/A | 1.80x1.12m (5'11"x3'8") |
| Burgundy 32x12-2 | 4 (Plus 2) | 1.91x1.37m (6'3"x4'6") | 1.83x0.69m (6'0"x2'3") / 1.76x0.69m (5'9"x2'3") | N/A | 1.80x1.12m (5'11"x3'8") |
| Burgundy 35x12-2 | 4 (Plus 2) | 1.91x1.37m (6'3"x4'6") | 1.83x0.69m (6'0"x2'3") / 1.76x0.69m (5'9"x2'0") | N/A | 1.80x1.12m (5'11"x3'8") |
| Burgundy 35x12-3 | 6 (Plus 2) | 1.91x1.37m (6'3"x4'6") | 1.83x0.69m (6'0"x2'3") / 1.76x0.69m (5'9"x2'3") | 1.83x0.61m (6'0"x2'0") | 1.80x1.12m (5'11"x3'8") |
| Soleil 28x10-2 | 4 (Plus 2) | 1.91x1.37m (6'3"x4'6") | 1.83x0.61m (6'0"x2'0") / 1.76x0.61m (5'9"x2'0") | N/A | 1.80x1.12m (5'11"x3'8") |
| Soleil 32x10-2 | 4 (Plus 2) | 1.91x1.37m (6'3"x4'6") | 1.83x0.69m (6'0"x2'3") / 1.76x0.69m (5'9"x2'3") | N/A | 1.80x1.12m (5'11"x3'8") |
| Soleil 35x10-3 | 6 (Plus 2) | 1.91x1.37m (6'3"x4'6") | 1.83x0.61m (6'0"x2'0") / 1.76x0.61m (5'9"x2'0") | 1.83x0.61m (6'0"x2'0") | 1.80x1.12m (5'11"x3'8") |
| Soleil 28x12-2 | 4 (Plus 2) | 1.91x1.37m (6'3"x4'6") | 1.83x0.69m (6'0"x2'3") / 1.76x0.69m (5'9"x2'3") | N/A | 1.80x1.12m (5'11"x3'8") |
| Soleil 32x12-2 | 4 (Plus 2) | 1.91x1.37m (6'3"x4'6") | 1.83x0.69m (6'0"x2'3") / 1.76x0.69m (5'9"x2'3") | N/A | 1.80x1.12m (5'11"x3'8") |
| Soleil 35x12-2 | 4 (Plus 2) | 1.91x1.37m (6'3"x4'6") | 1.83x0.69m (6'0"x2'3") / 1.76x0.69m (5'9"x2'0") | N/A | 1.80x1.12m (5'11"x3'8") |
| Soleil 35x12-3 | 6 (Plus 2) | 1.91x1.37m (6'3"x4'6") | 1.83x0.69m (6'0"x2'3") / 1.76x0.69m (5'9"x2'3") | 1.83x0.61m (6'0"x2'0") | 1.80x1.12m (5'11"x3'8") |
| Bordeaux 33x12-2 | 4 (Plus 2) | 1.91x1.37m (6'3"x4'6") | 1.83x0.69m (6'0"x2'3") | N/A | 1.80x1.12m (5'11"x3'8") |
| Bordeaux 35x12-2 | 4 (Plus 2) | 1.91x1.53m (6'3"x5'0") | 1.83x0.69m (6'0"x2'3") | N/A | 1.80x1.12m (5'11"x3'8") |
| Bordeaux 38x12-2 | 4 (Plus 2) | 1.91x1.53m (6'3"x5'0") | 1.83x0.69m (6'0"x2'3") | N/A | 1.80x1.12m (5'11"x3'8") |
| Bordeaux 38x12-3 | 6 (Plus 2) | 1.91x1.37m (6'3"x4'6") | 1.83x0.69m (6'0"x2'3") | 1.83x0.61m (6'0"x2'0") | 1.80x1.12m (5'11"x3'8") |

MODEL NAMES, BERTHS AND BED SIZES

| Model | Berths | Double | Twin | Rear Twin | Sofa Bed |
|-------------------------|------------|------------------------|---|---|-------------------------|
| Moselle 35x12-2 | 4 (Plus 2) | 1.91x1.53m (6'3"x5'0") | 1.83x0.69m (6'0"x2'3") | N/A | 1.80x1.12m (5'11"x3'8") |
| Moselle 38x12-2 | 4 (Plus 2) | 1.91x1.53m (6'3"x5'0") | 1.83x0.69m (6'0"x2'3") | N/A | 1.80x1.12m (5'11"x3'8") |
| Moselle 38x12-2 Bath | 4 (Plus 2) | 1.91x1.53m (6'3"x5'0") | 1.83x0.69m (6'0"x2'3") | N/A | 1.80x1.12m (5'11"x3'8") |
| Moselle 38x12-3 | 6 (Plus 2) | 1.91x1.37m (6'3"x4'6") | 1.83x0.69m (6'0"x2'3") | 1.83x0.61m (6'0"x2'0") | 1.80x1.12m (5'11"x3'8") |
| Auvergne 38x12-2 (FL) | 4 (Plus 2) | 1.91x1.53m (6'3"x5'0") | 1.83x0.69m (6'0"x2'3") | N/A | 1.80x1.12m (5'11"x3'8") |
| Auvergne 38x12-2 (FK) | 4 (Plus 2) | 1.91x1.53m (6'3"x5'0") | 1.83x0.69m (6'0"x2'3") | N/A | 1.80x1.12m (5'11"x3'8") |
| Chamonix 36x12-2 | 4 (Plus 2) | 1.91x1.53m (6'3"x5'0") | 1.83x0.69m (6'0"x2'3") | N/A | 1.80x1.12m (5'11"x3'8") |
| Chamoniox 39x12-2 (OL) | 6 (Plus 2) | 1.91x1.53m (6'3"x5'0") | 1.83x0.69m (6'0"x2'3") | N/A | 1.80x1.12m (5'11"x3'8") |
| Champagne 41x13-2 | 4 (Plus 2) | 1.91x1.53m (6'3"x5'0") | 1.83x0.75m (6'0"x2'6") | N/A | 1.80x1.12m (5'11"x3'8") |
| SPECIALS | | | | | |
| Family Retreat 38x12-3 | 6 (Plus 2) | 1.91x1.37m (6'3"x4'6") | 1.83x0.69m (6'0"x2'3") /1.76x0.69m (5'9"x2'3") | 191 x 0.59m (6'3" x1'11") 1.83x0.69m (6'0"x2'3") | 1.80x1.12m (5'11"x3'8") |
| Provence 38x12-3 | 6 (Plus 2) | 1.91x1.37m (6'3"x4'6") | 1.83x0.69m (6'0"x2'3") | 1.83x0.69m (6'0"x2'3") | 1.80x1.12m (5'11"x3'8") |
| Serenity 38x12-3 | 6 (Plus 2) | 1.91x1.37m (6'3"x4'6") | 1.83x0.69m (6'0"x2'3") | 1.83x0.69m (6'0"x2'3") | 1.80x1.12m (5'11"x3'8") |
| Coastal Retreat 38x12-2 | 4 (Plus 2) | 1.91x1.37m (6'3"x4'6") | 1.83x0.69m (6'0"x2'3") | N/A | 1.80x1.12m (5'11"x3'8") |
| Woodland Escape 38x12-2 | 4 (Plus 2) | 1.91x1.37m (6'3"x4'6") | 1.83x0.69m (6'0"x2'3") | N/A | 1.80x1.12m (5'11"x3'8") |

Technical Info

GENERAL LAYOUT SHOWING VENTILATION AND EMERGENCY EXITS

Burgundy 28' x 10' 2 bed layout

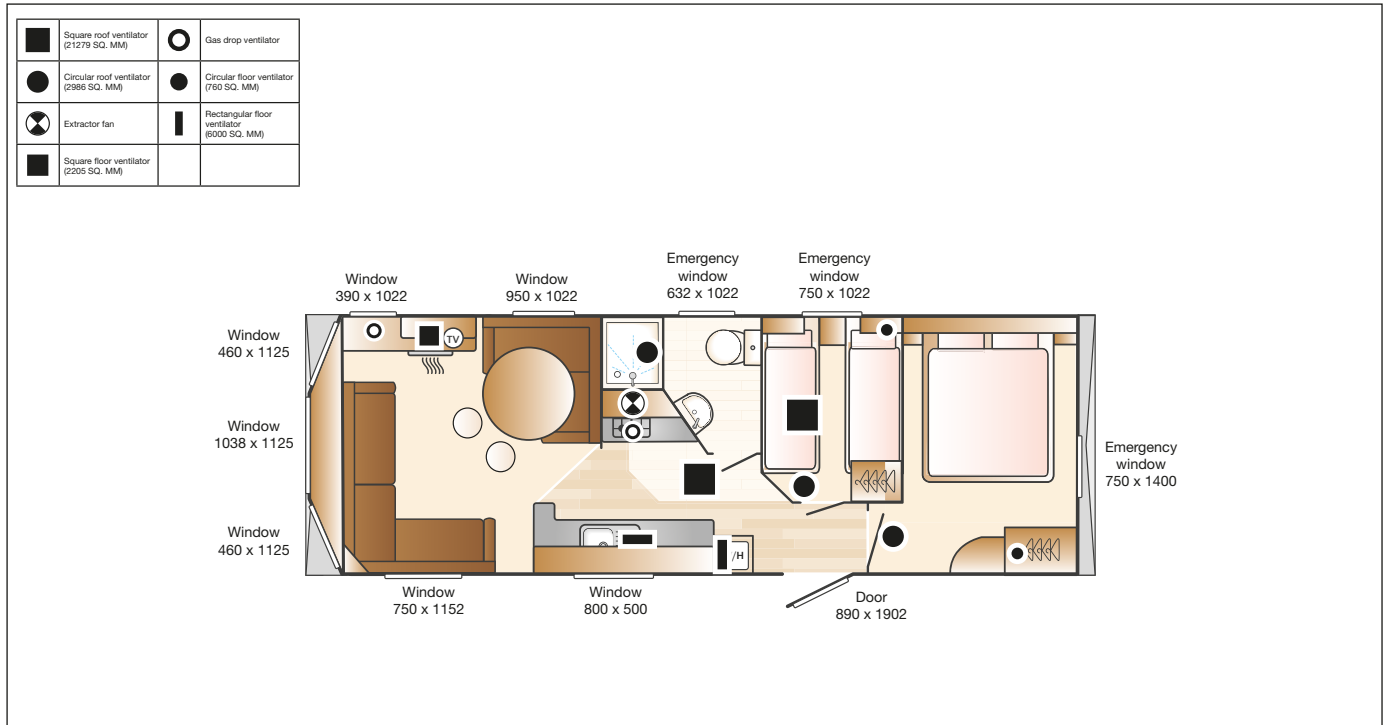

GENERAL LAYOUT SHOWING VENTILATION AND EMERGENCY EXITS

Burgundy 32' x 10' 2 bed layout

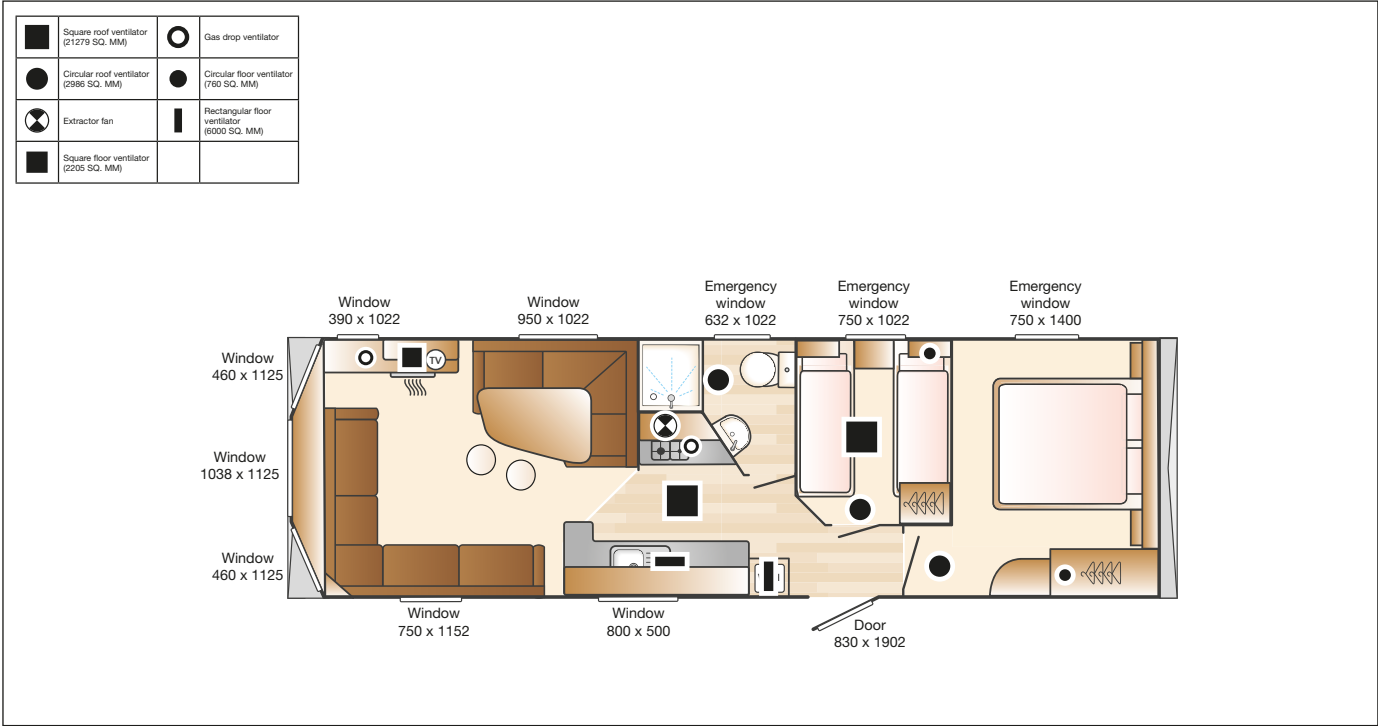

GENERAL LAYOUT SHOWING VENTILATION AND EMERGENCY EXITS

Burgundy 28' x 12' 2 bed layout

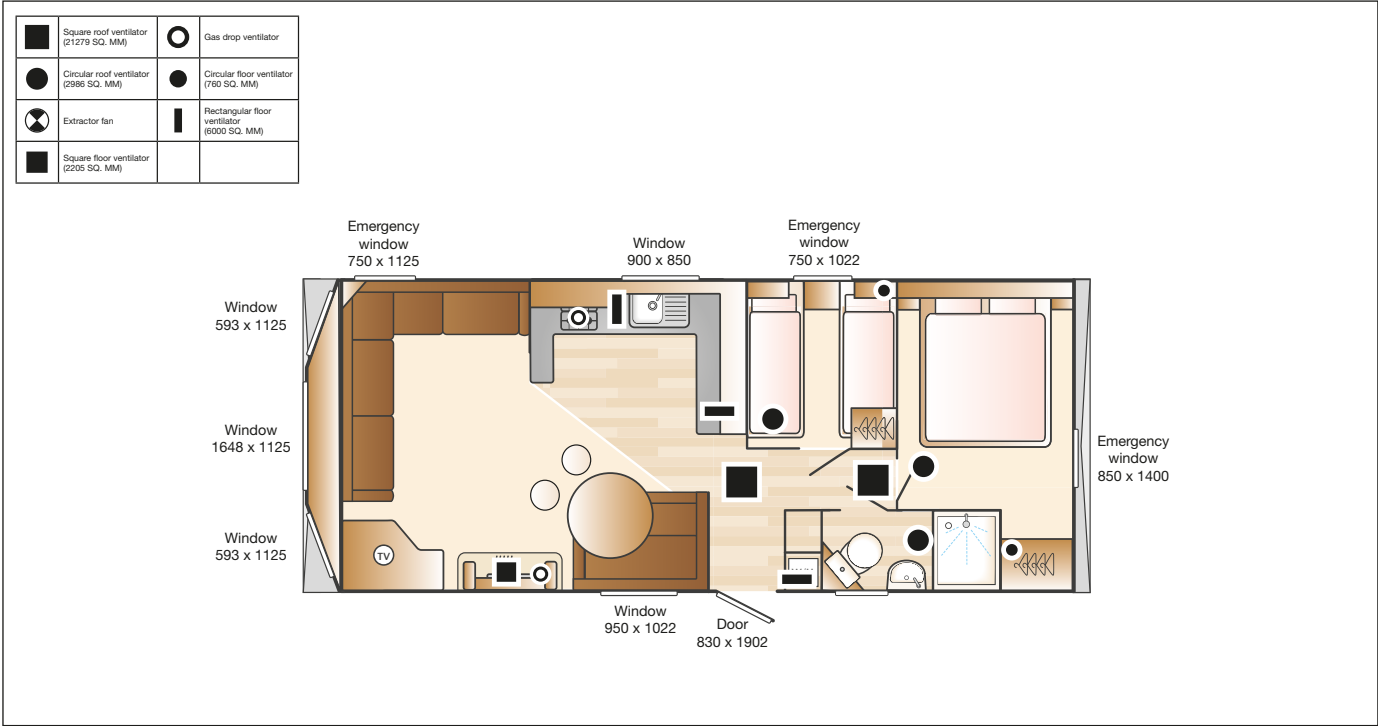

Technical Info

GENERAL LAYOUT SHOWING VENTILATION AND EMERGENCY EXITS

Burgundy 32' x 12' 2 bed layout

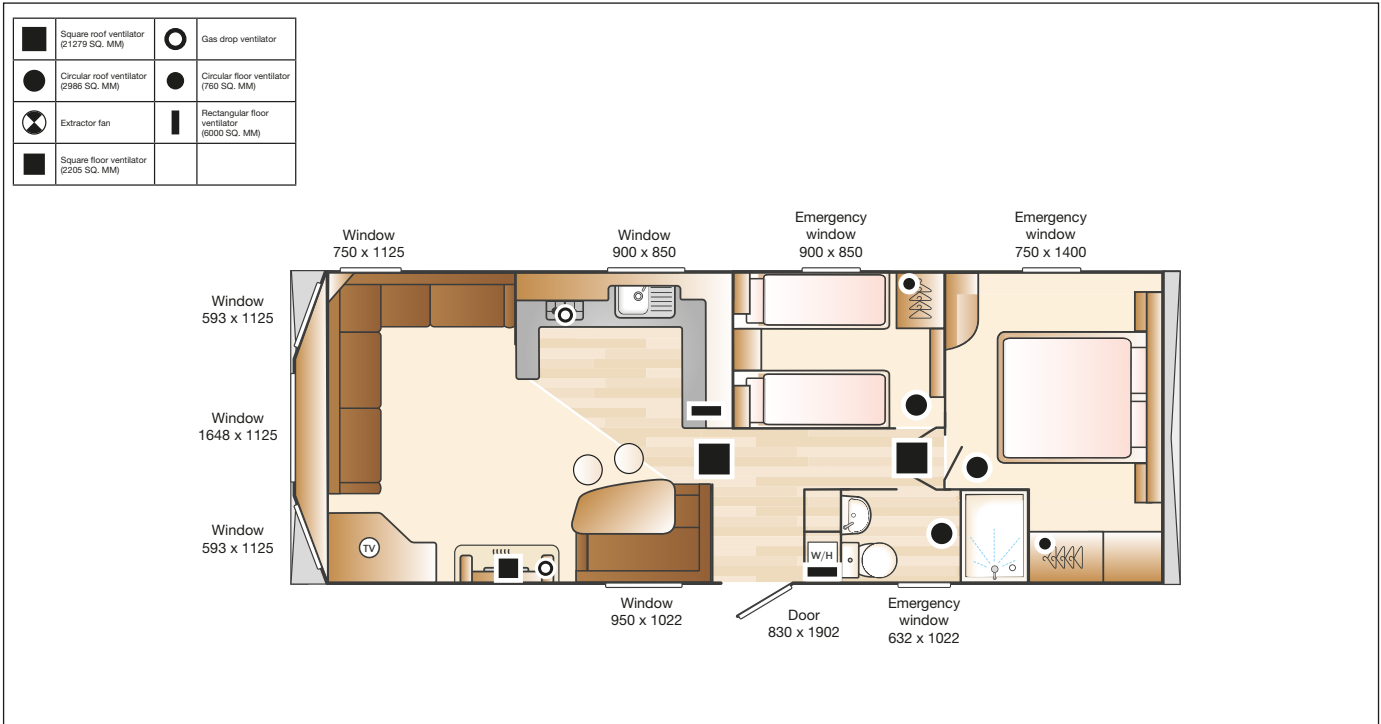

GENERAL LAYOUT SHOWING VENTILATION AND EMERGENCY EXITS

Burgundy 35' x 12' 2 bed layout

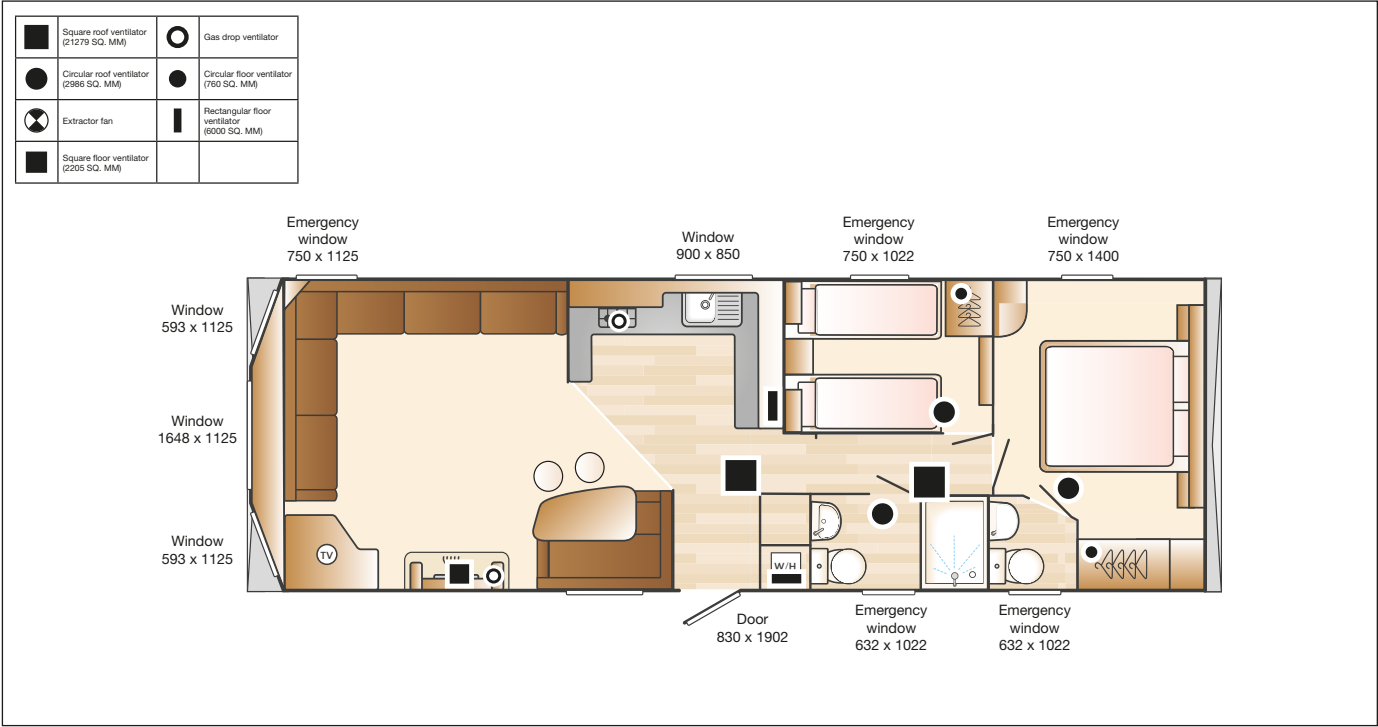

Technical Info

GENERAL LAYOUT SHOWING VENTILATION AND EMERGENCY EXITS

Burgundy 35' x 12' 3 bed layout

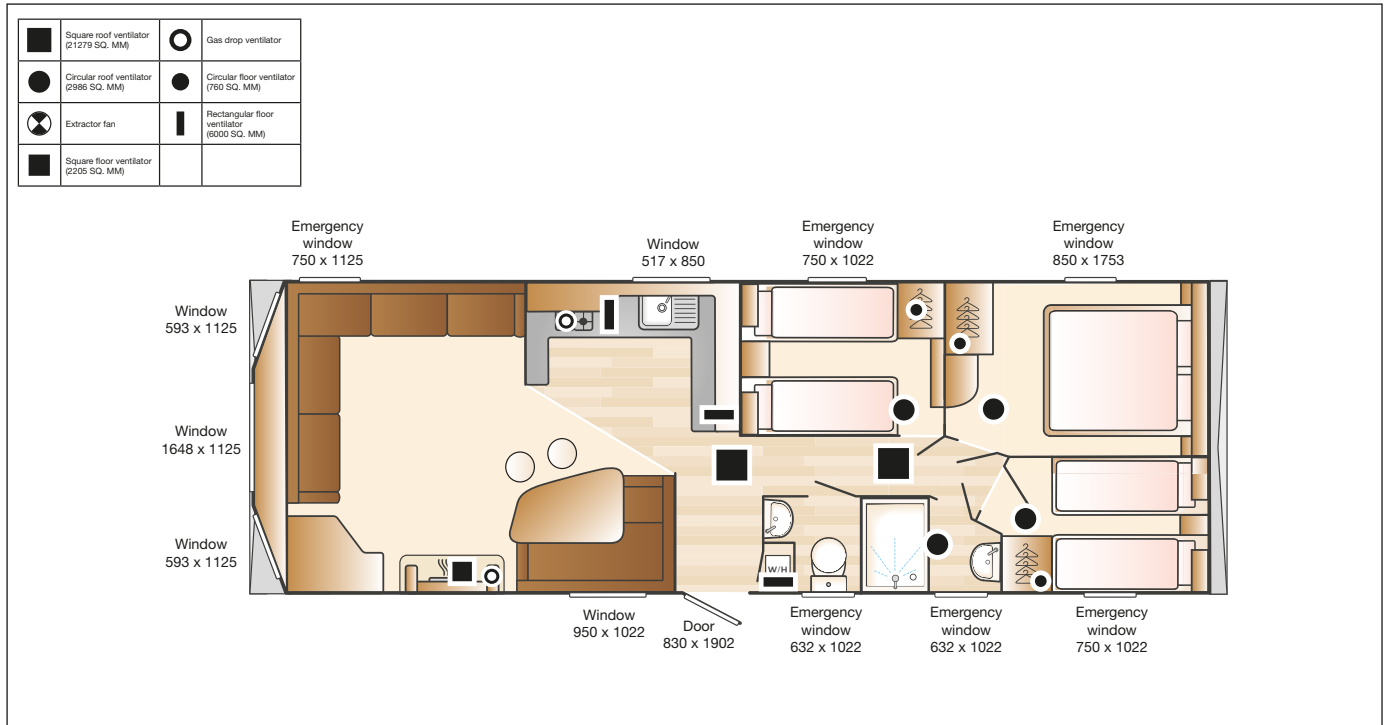

GENERAL LAYOUT SHOWING VENTILATION AND EMERGENCY EXITS

Soleil 28' x 10' 2 bed layout

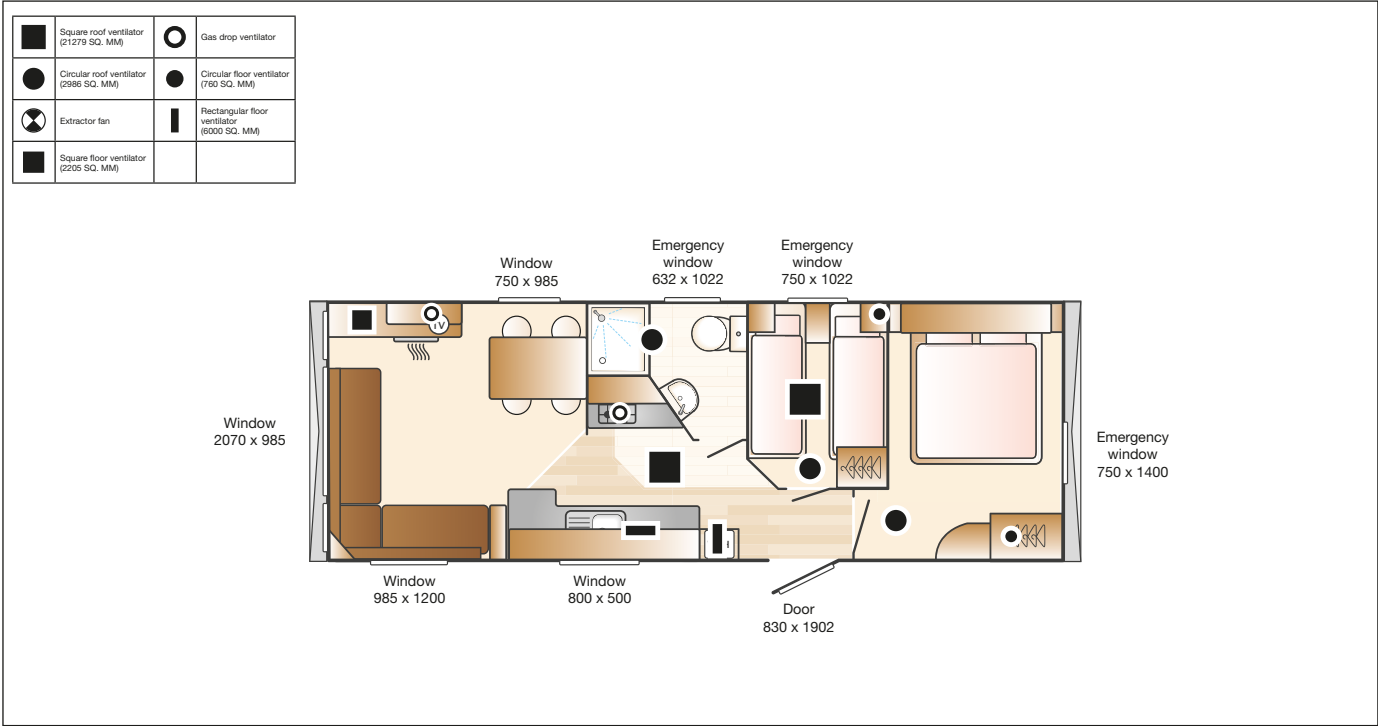

Technical Info

GENERAL LAYOUT SHOWING VENTILATION AND EMERGENCY EXITS

Soleil 32' x 10' 2 bed layout

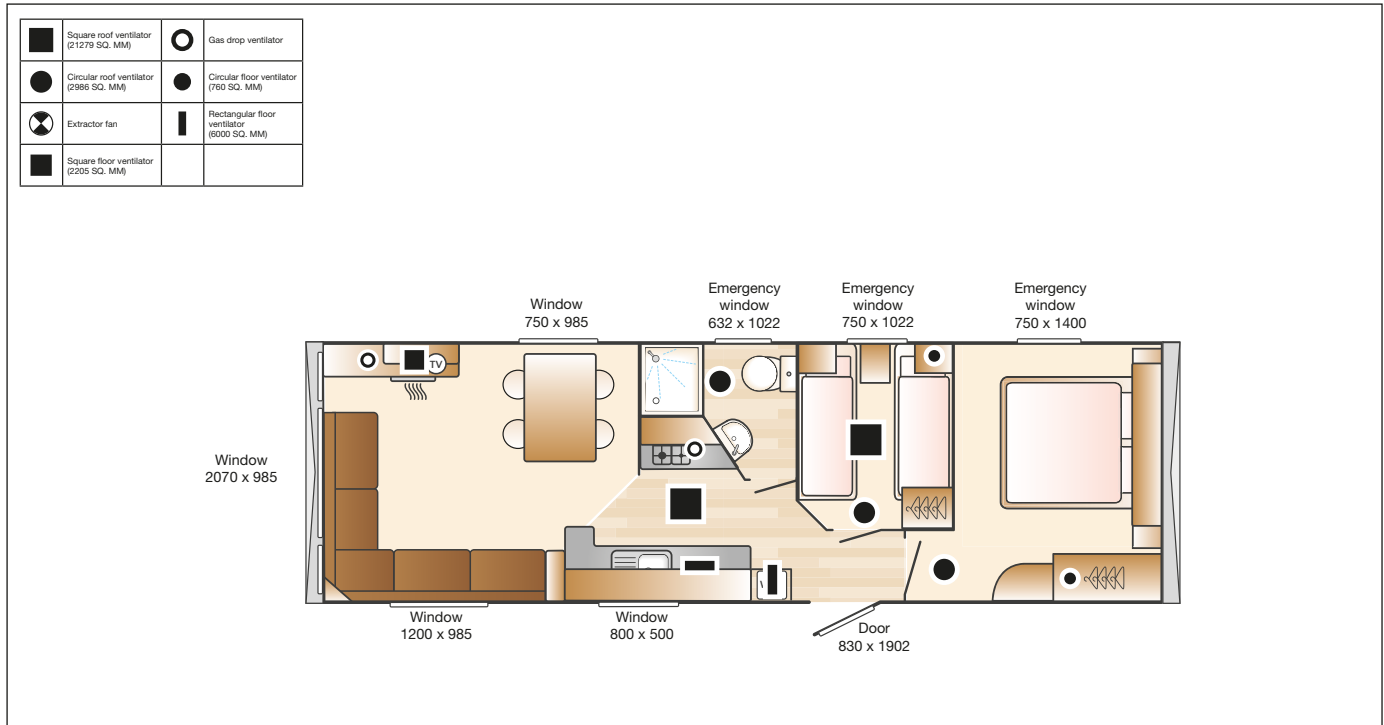

GENERAL LAYOUT SHOWING VENTILATION AND EMERGENCY EXITS

Soleil 35' x 10' 3 bed layout

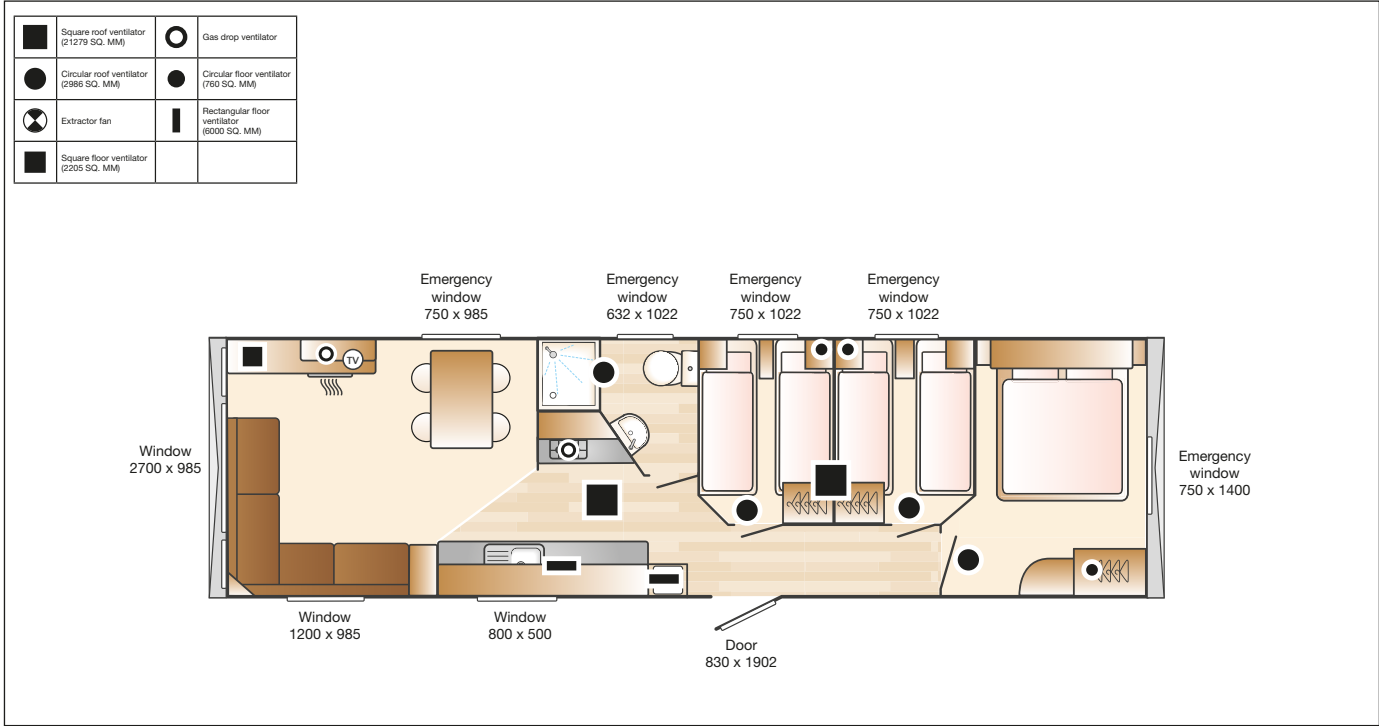

Technical Info

GENERAL LAYOUT SHOWING VENTILATION AND EMERGENCY EXITS

Soleil 28' x 12' 2 bed layout

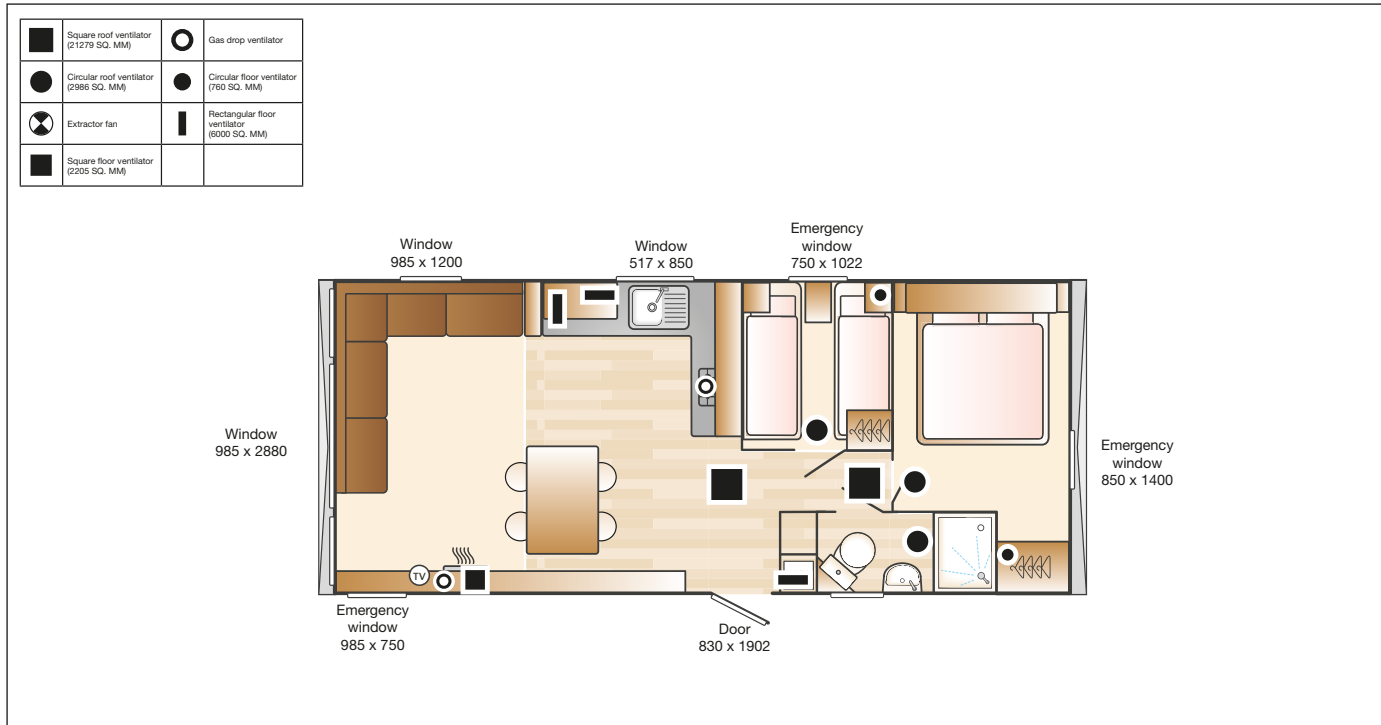

GENERAL LAYOUT SHOWING VENTILATION AND EMERGENCY EXITS

Soleil 32' x 12' 2 bed layout

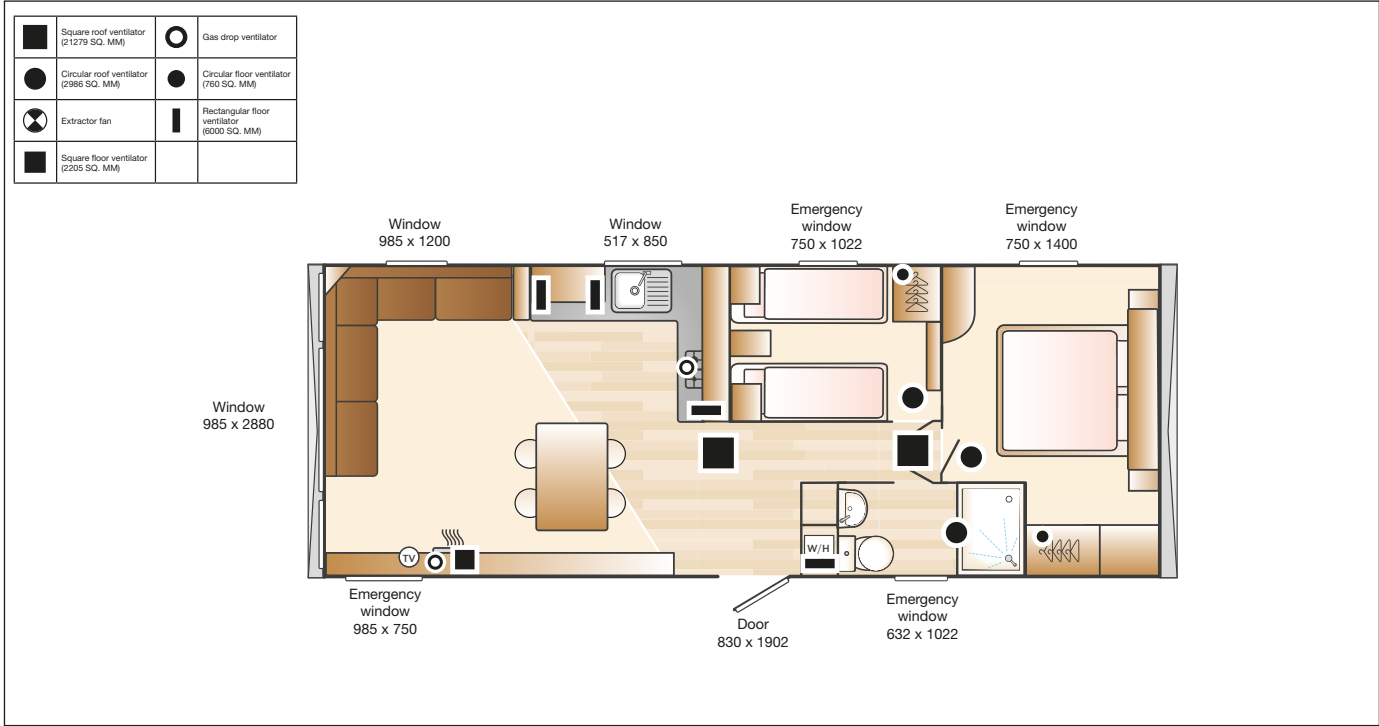

Technical Info

GENERAL LAYOUT SHOWING VENTILATION AND EMERGENCY EXITS

Soleil 35' x 12' 2 bed layout

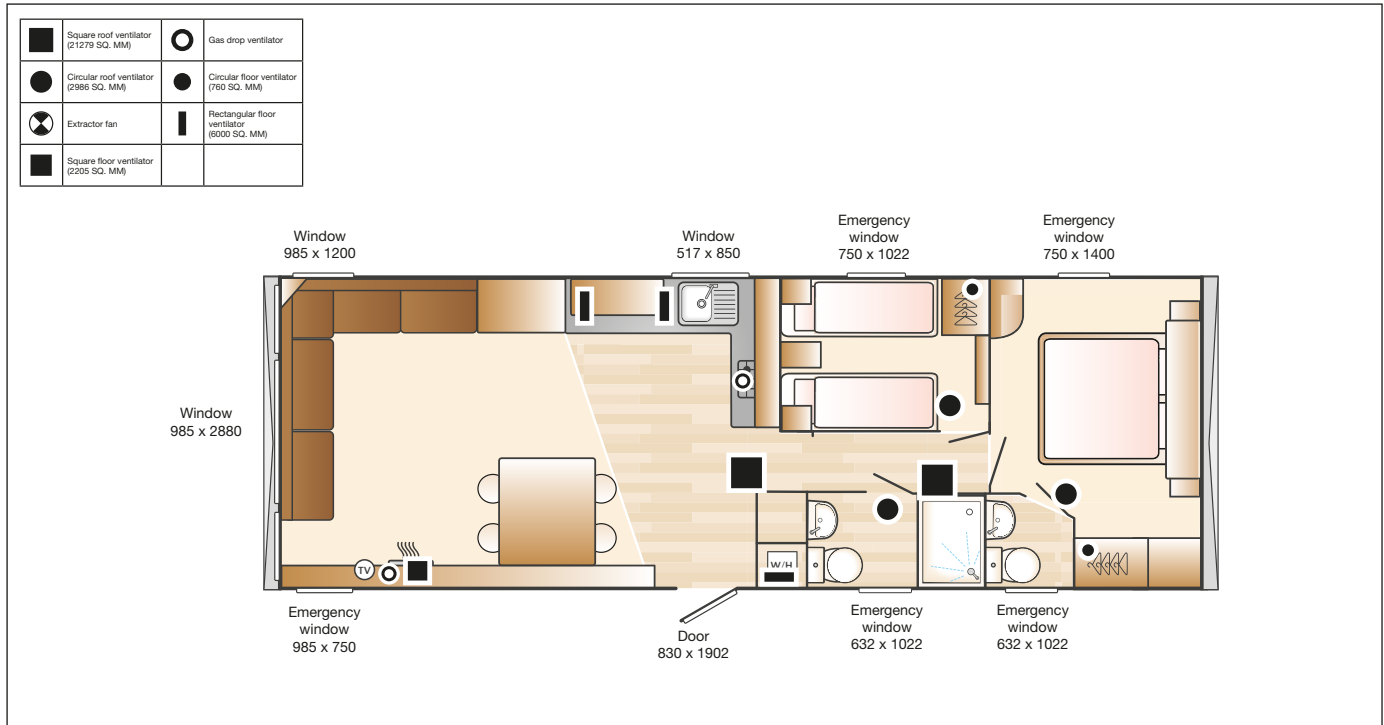

GENERAL LAYOUT SHOWING VENTILATION AND EMERGENCY EXITS

Soleil 35' x 12' 3 bed layout

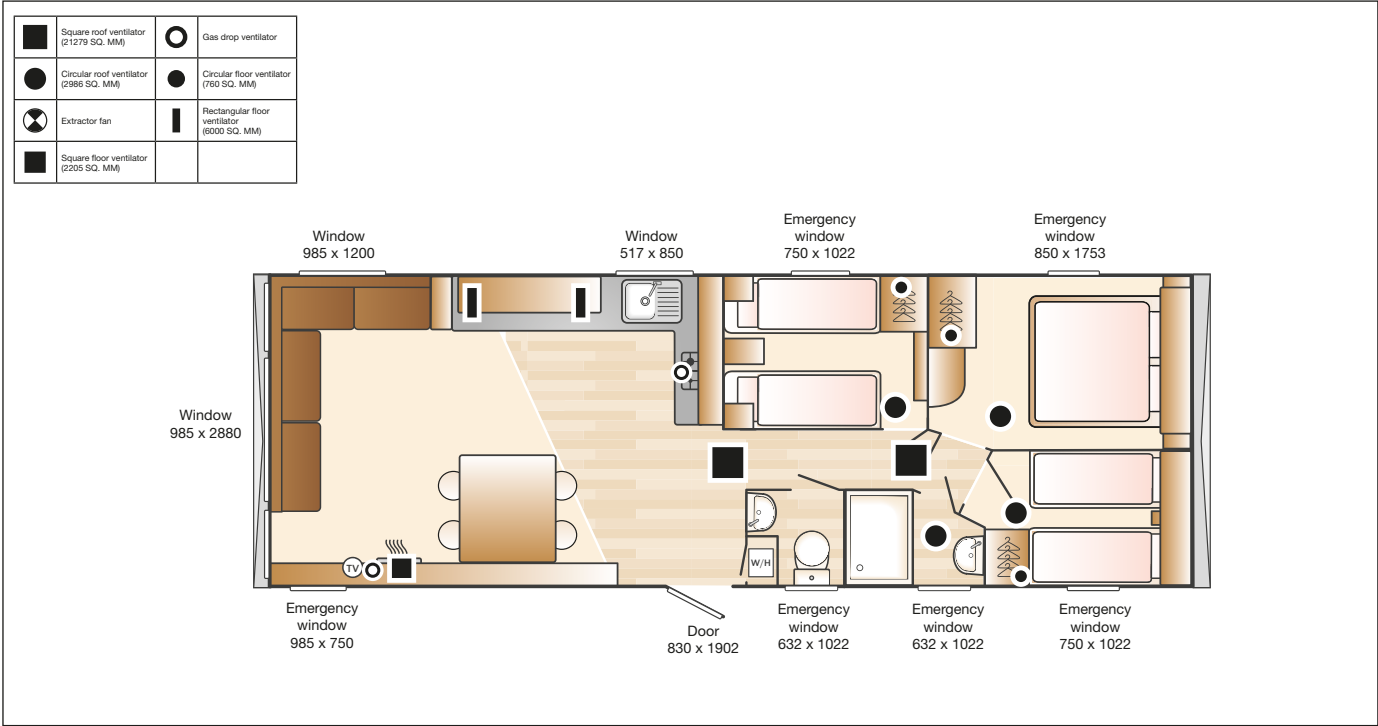

Technical Info

GENERAL LAYOUT SHOWING VENTILATION AND EMERGENCY EXITS

Bordeaux 33' x 12' 2 bed layout

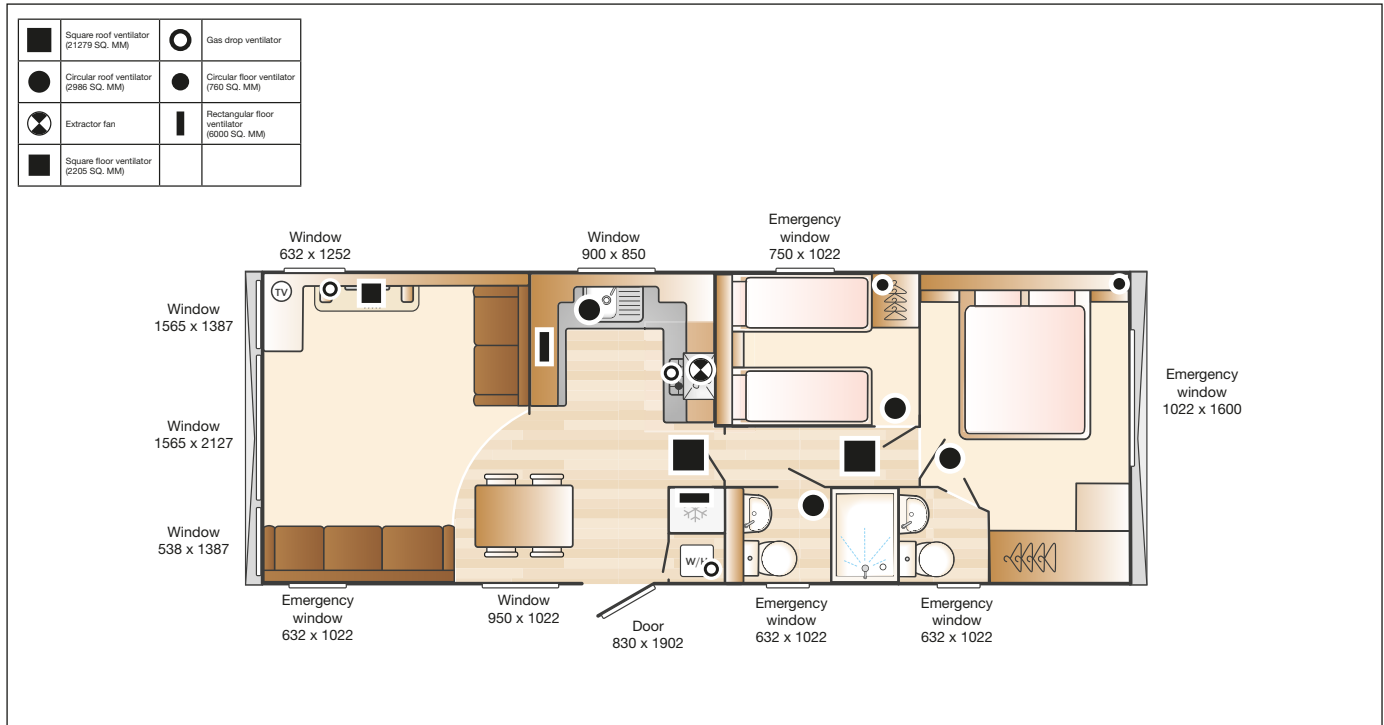

GENERAL LAYOUT SHOWING VENTILATION AND EMERGENCY EXITS

Bordeaux 35' x 12' 2 bed layout

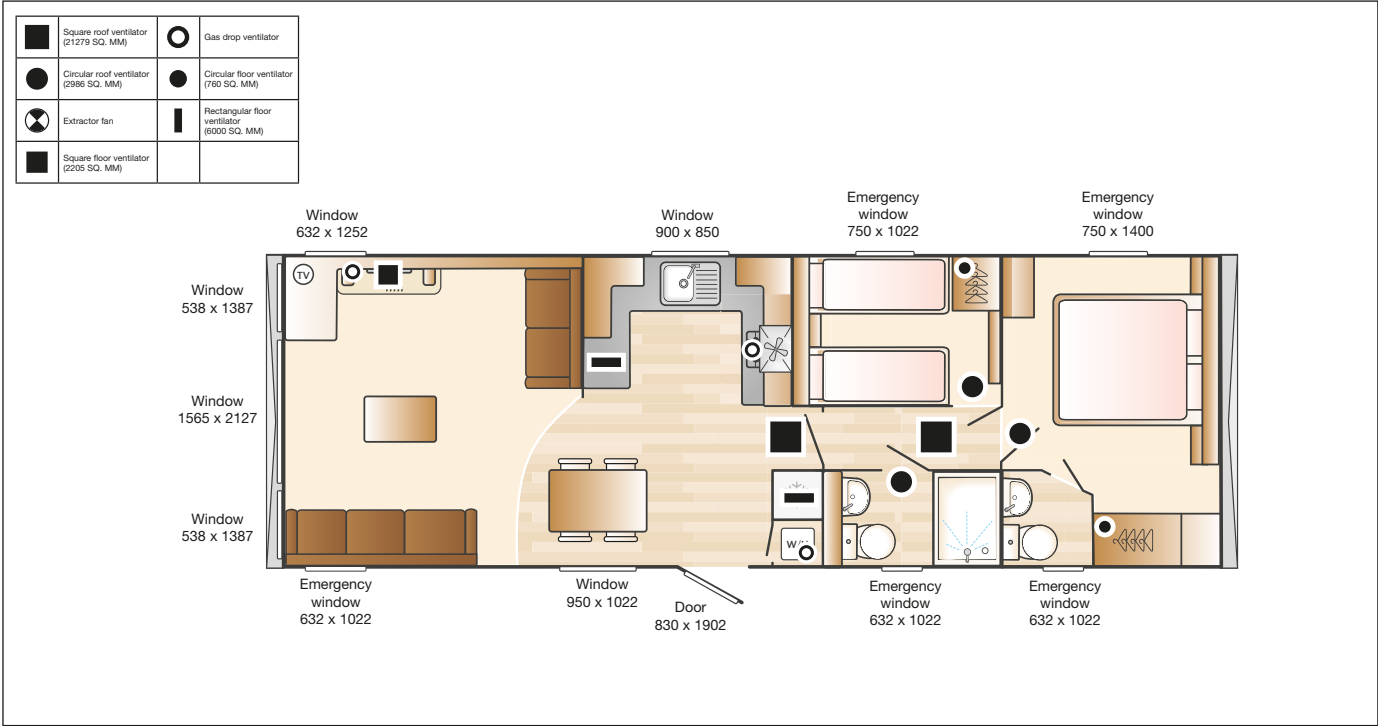

Technical Info

GENERAL LAYOUT SHOWING VENTILATION AND EMERGENCY EXITS

Bordeaux 38' x 12' 2 bed layout

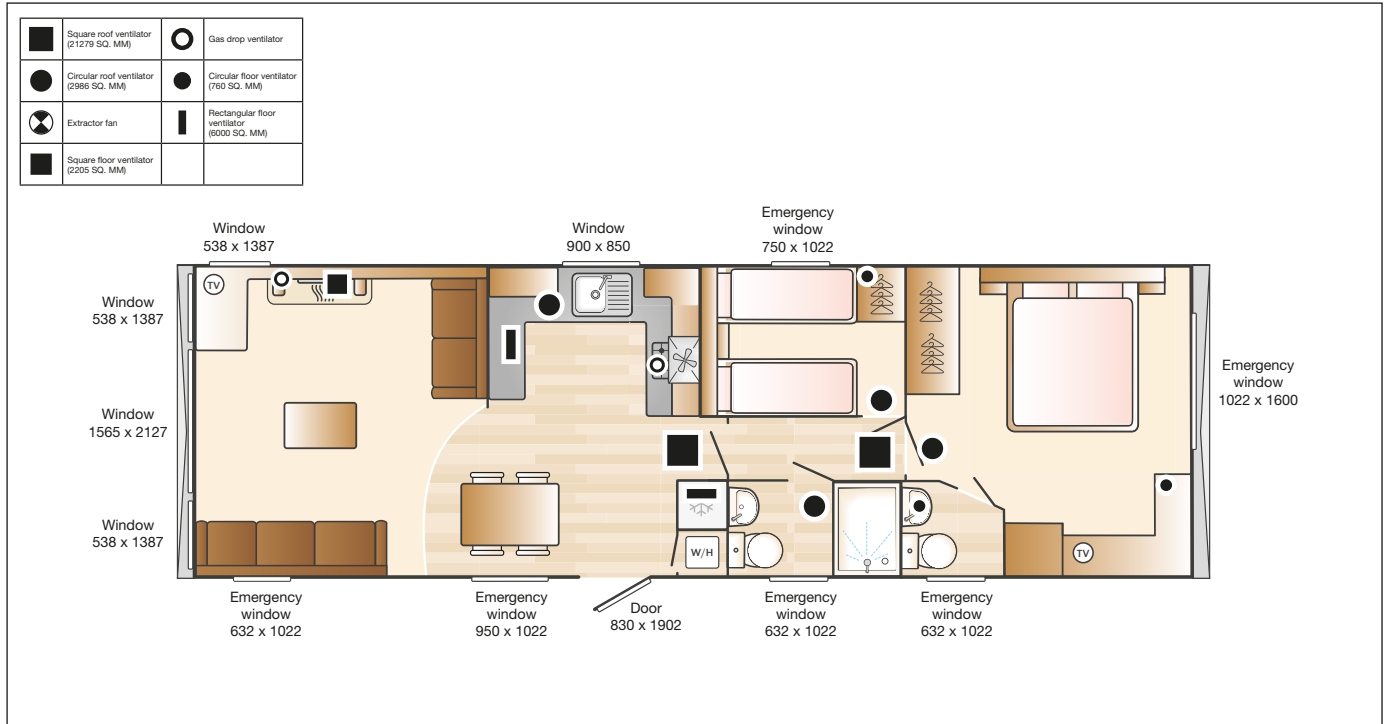

GENERAL LAYOUT SHOWING VENTILATION AND EMERGENCY EXITS

Bordeaux 38 x 12 3 bed layout

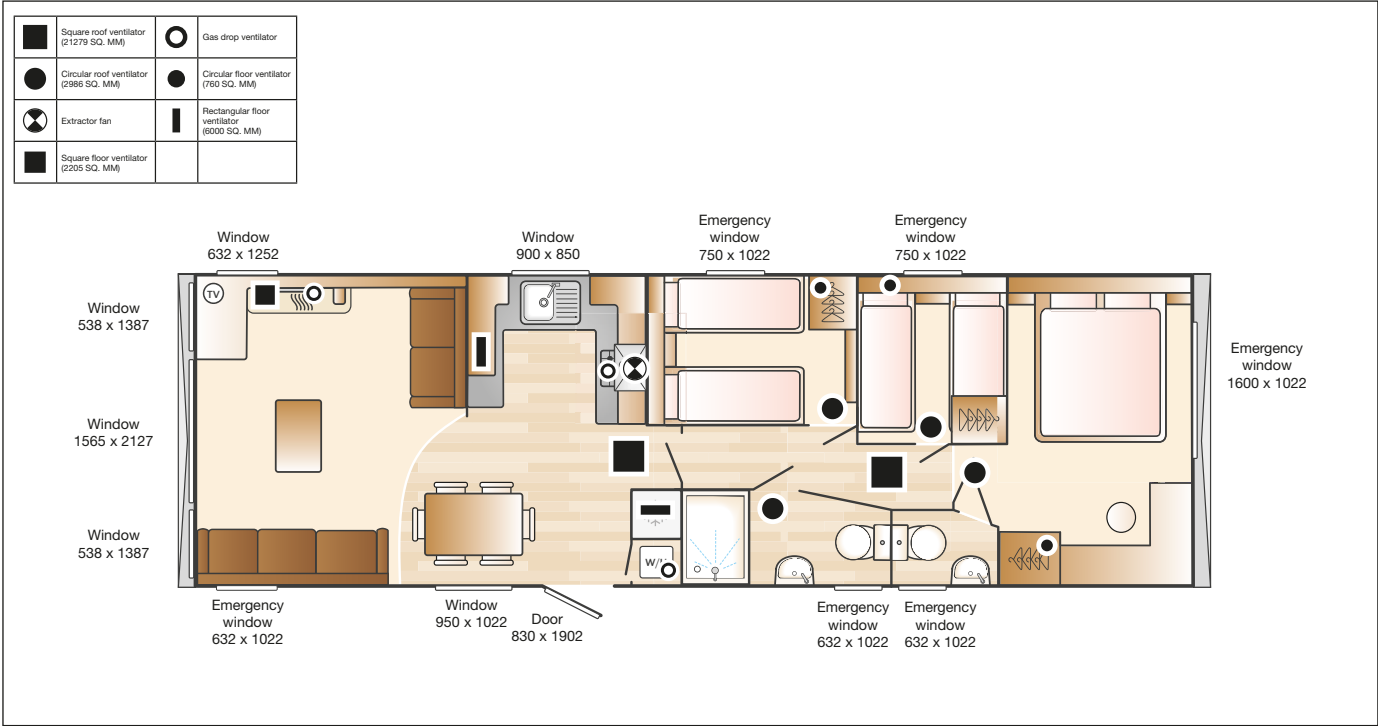

Technical Info

GENERAL LAYOUT SHOWING VENTILATION AND EMERGENCY EXITS

Moselle 35' x 12' 2 bed layout

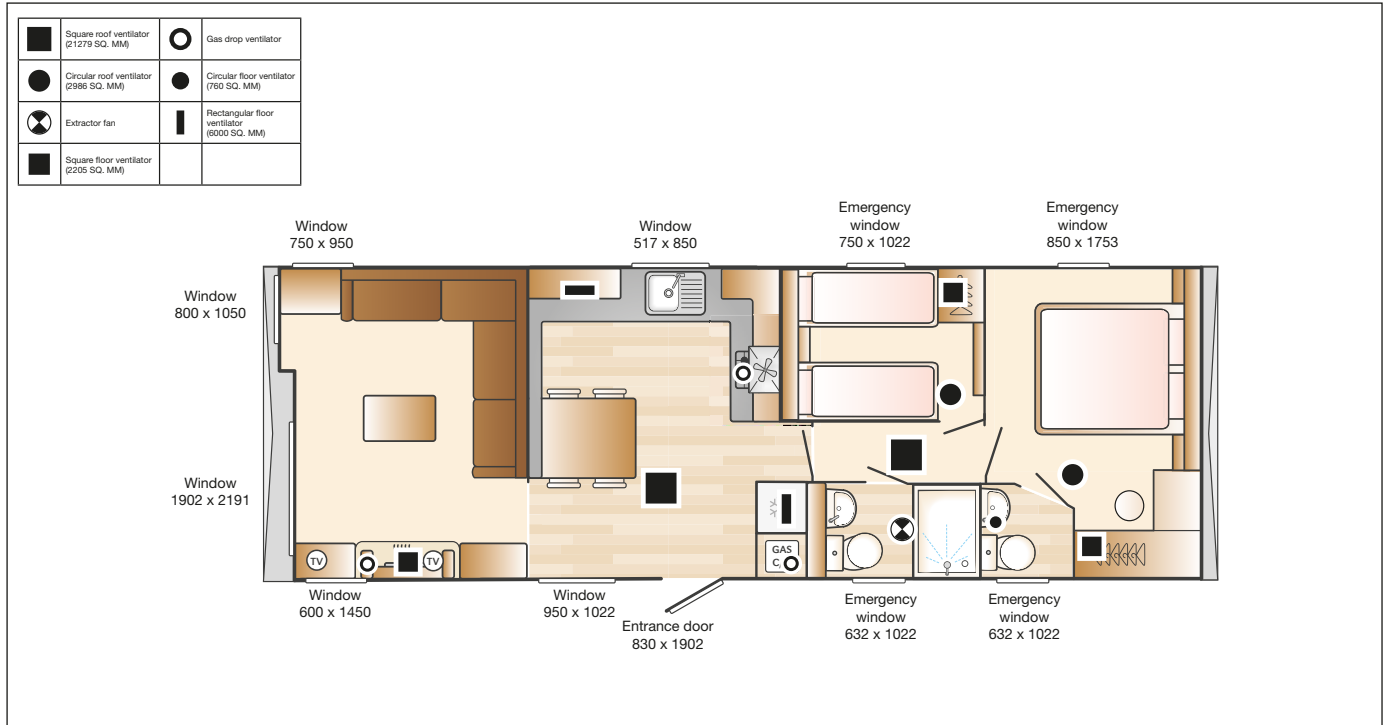

GENERAL LAYOUT SHOWING VENTILATION AND EMERGENCY EXITS

Moselle 38' x 12' 2 bed layout

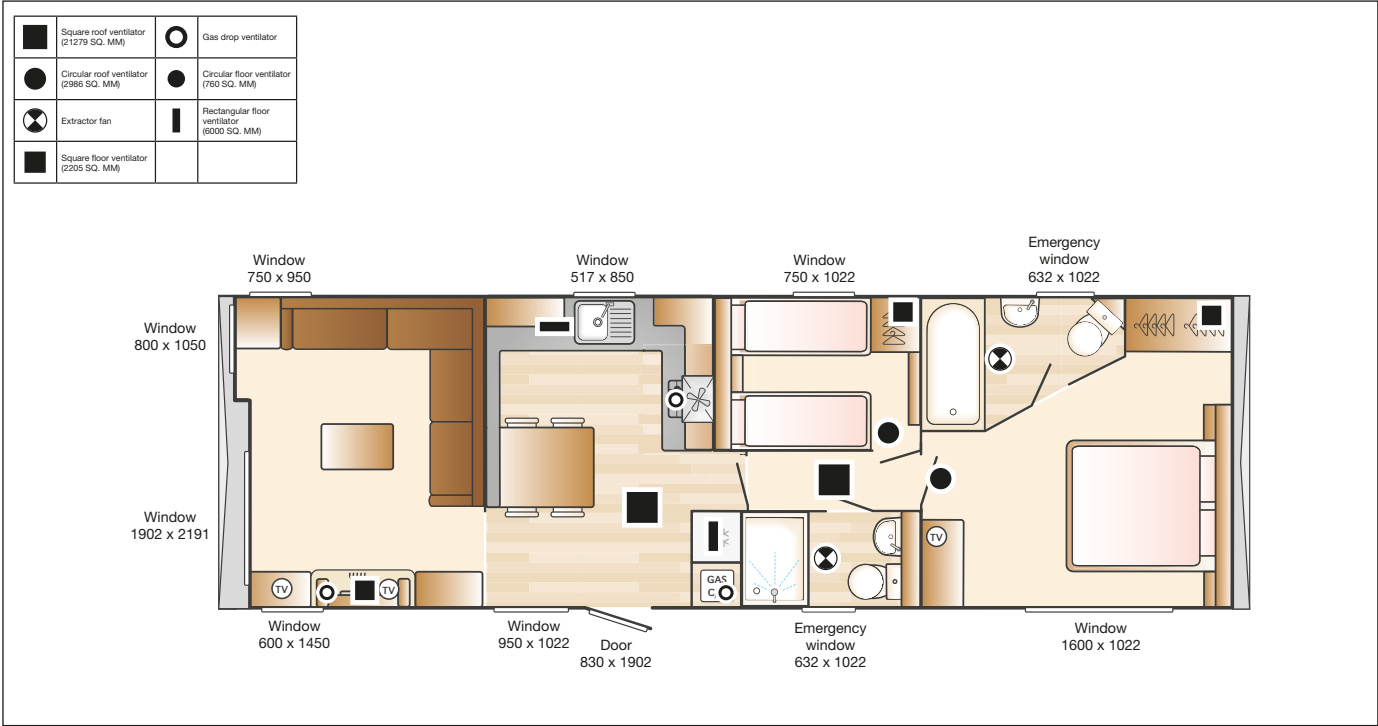

Technical Info

GENERAL LAYOUT SHOWING VENTILATION AND EMERGENCY EXITS

Moselle 38' x 12' 2 bed (bath) layout

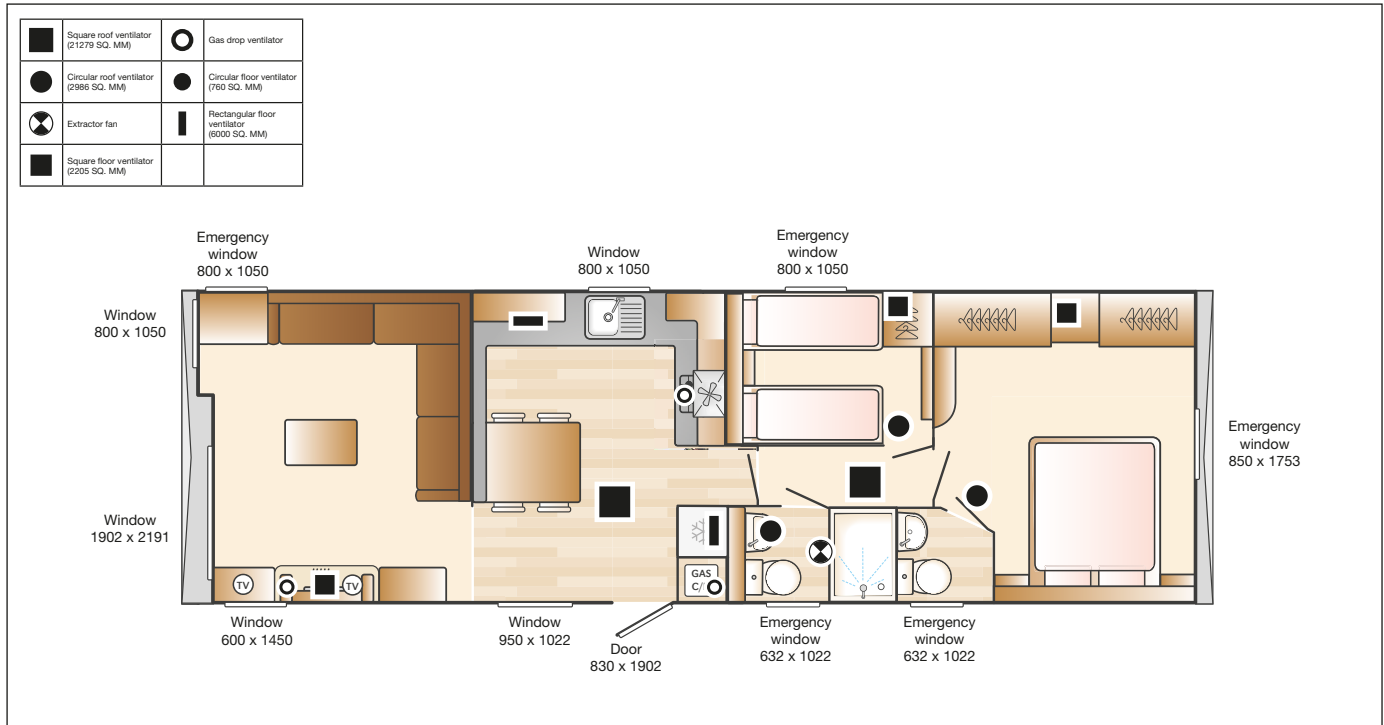

GENERAL LAYOUT SHOWING VENTILATION AND EMERGENCY EXITS

Moselle 38' x 12' 3 bed layout

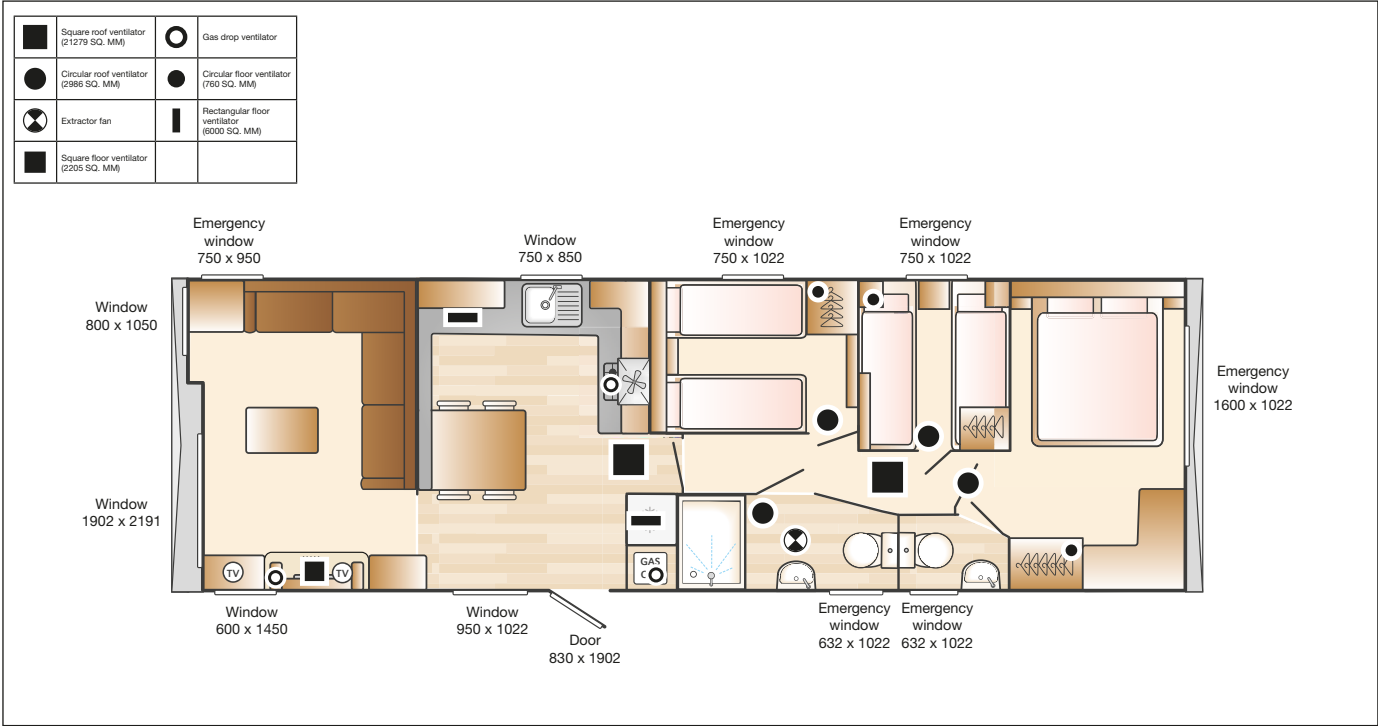

Technical Info

GENERAL LAYOUT SHOWING VENTILATION AND EMERGENCY EXITS

Auvergne 38' x 12' 2 bed (FL) layout

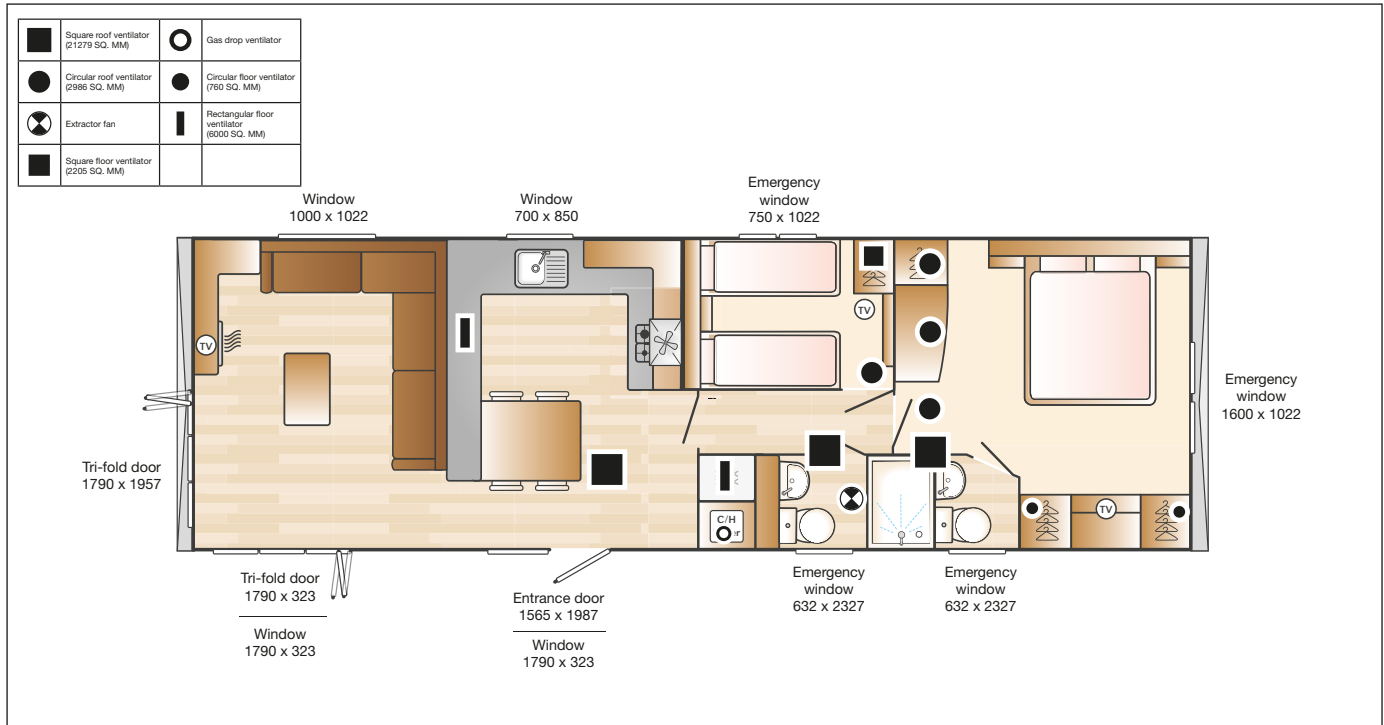

GENERAL LAYOUT SHOWING VENTILATION AND EMERGENCY EXITS

Auvergne 38' x 12' 2 bed (FK) layout

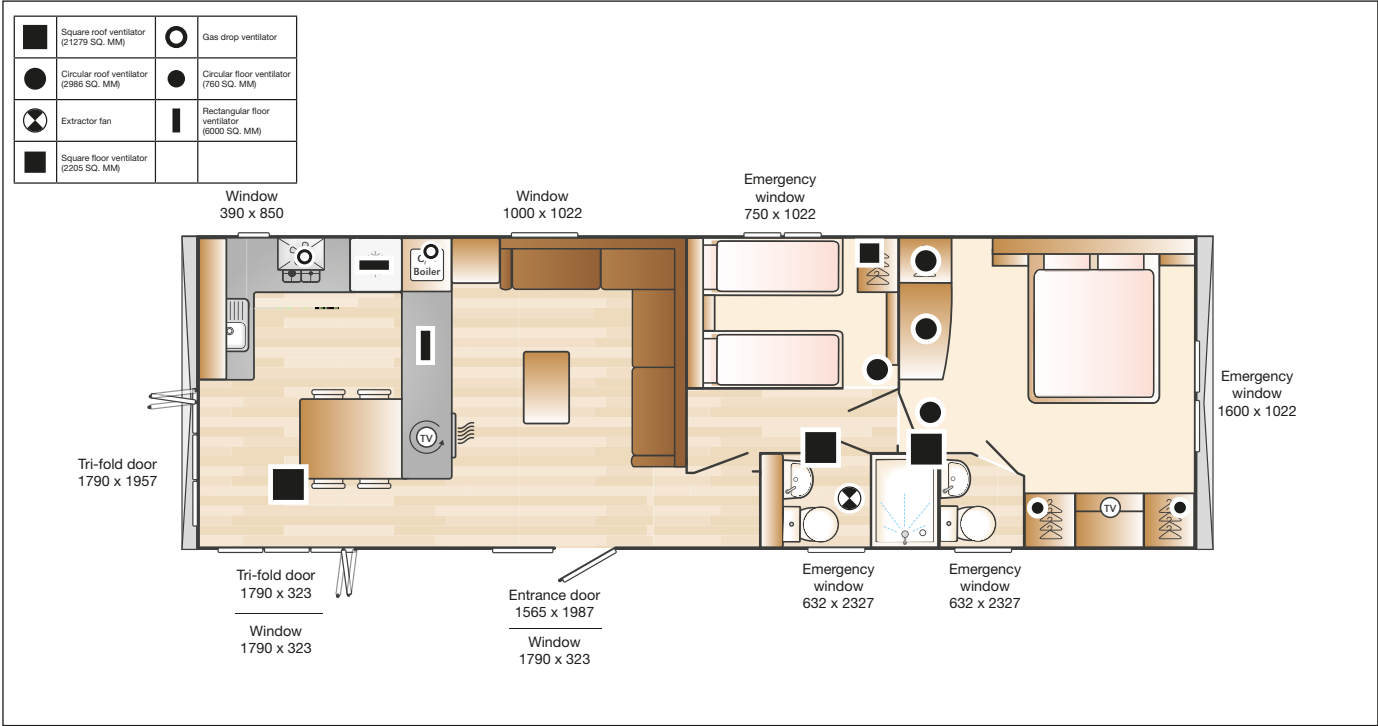

Technical Info

GENERAL LAYOUT SHOWING VENTILATION AND EMERGENCY EXITS

Chamonix 36' x 12' 2 bed layout closed lounge

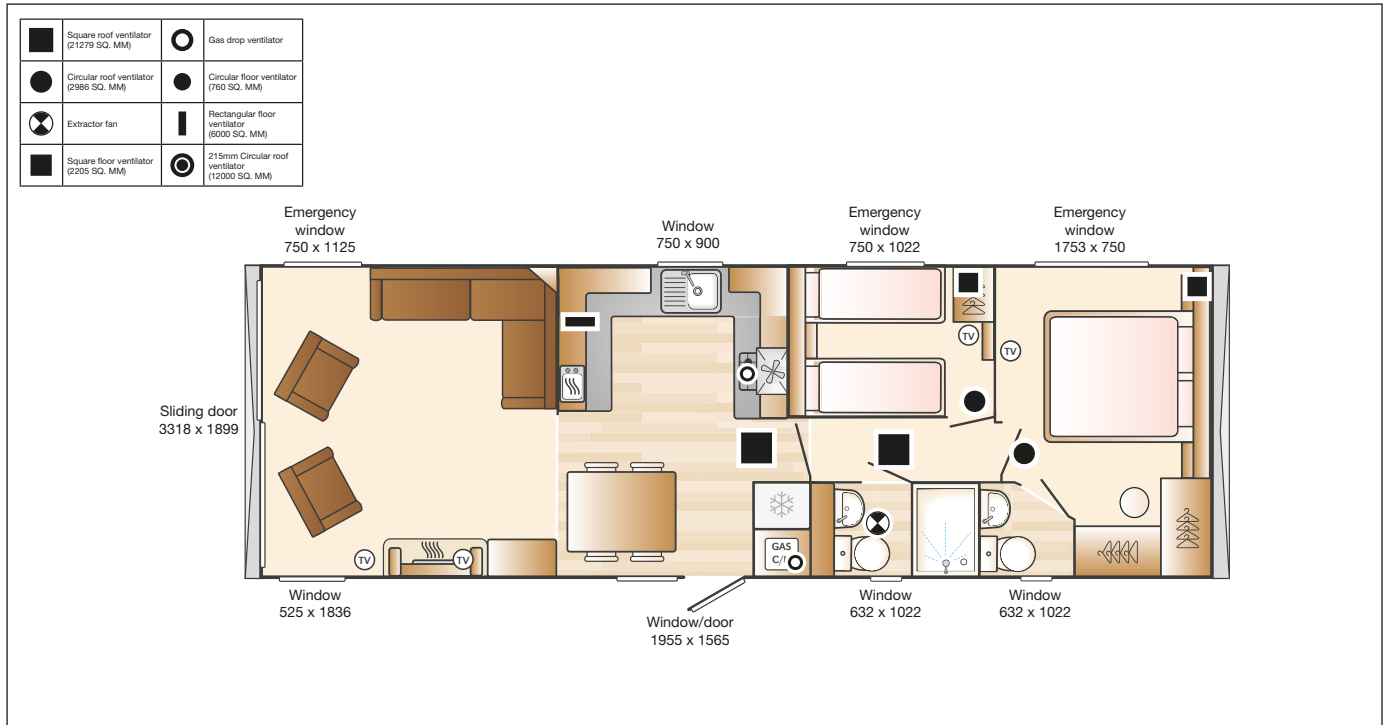

GENERAL LAYOUT SHOWING VENTILATION AND EMERGENCY EXITS

Chamonix 39' x 12' 2 bed layout open lounge

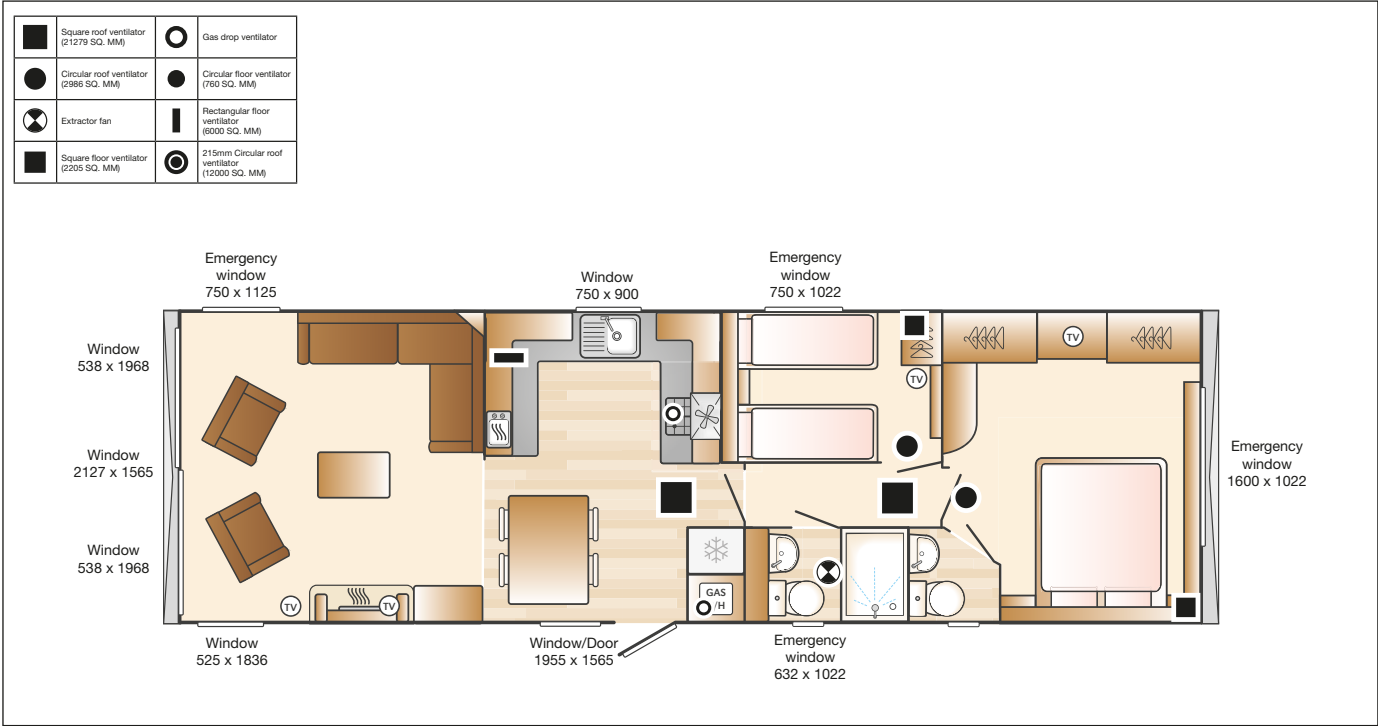

Technical Info

GENERAL LAYOUT SHOWING VENTILATION AND EMERGENCY EXITS

Champagne 41' x 13' 2 bed layout

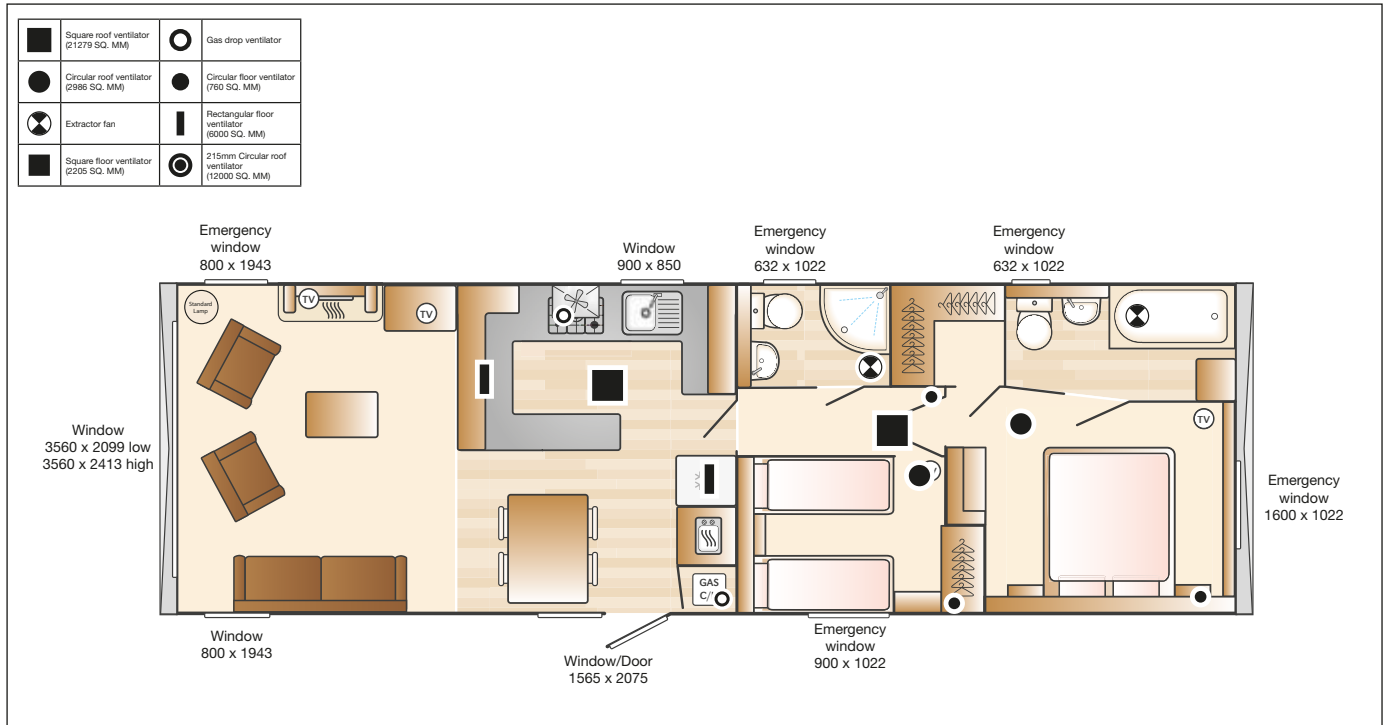

GENERAL LAYOUT SHOWING VENTILATION AND EMERGENCY EXITS

Family Retreat 38' x 12' 3 bed layout

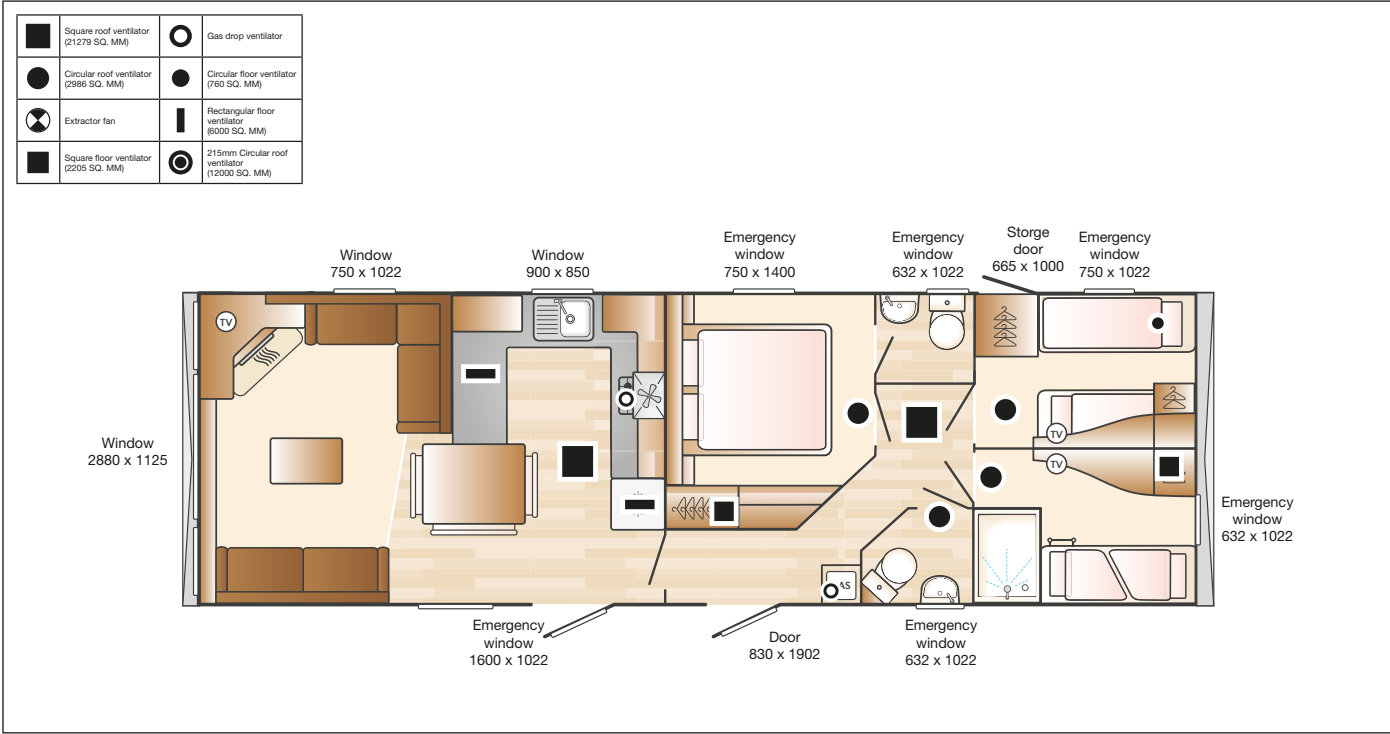

Technical Info

GENERAL LAYOUT SHOWING VENTILATION AND EMERGENCY EXITS

Provence 38' x 12' 3 bed layout

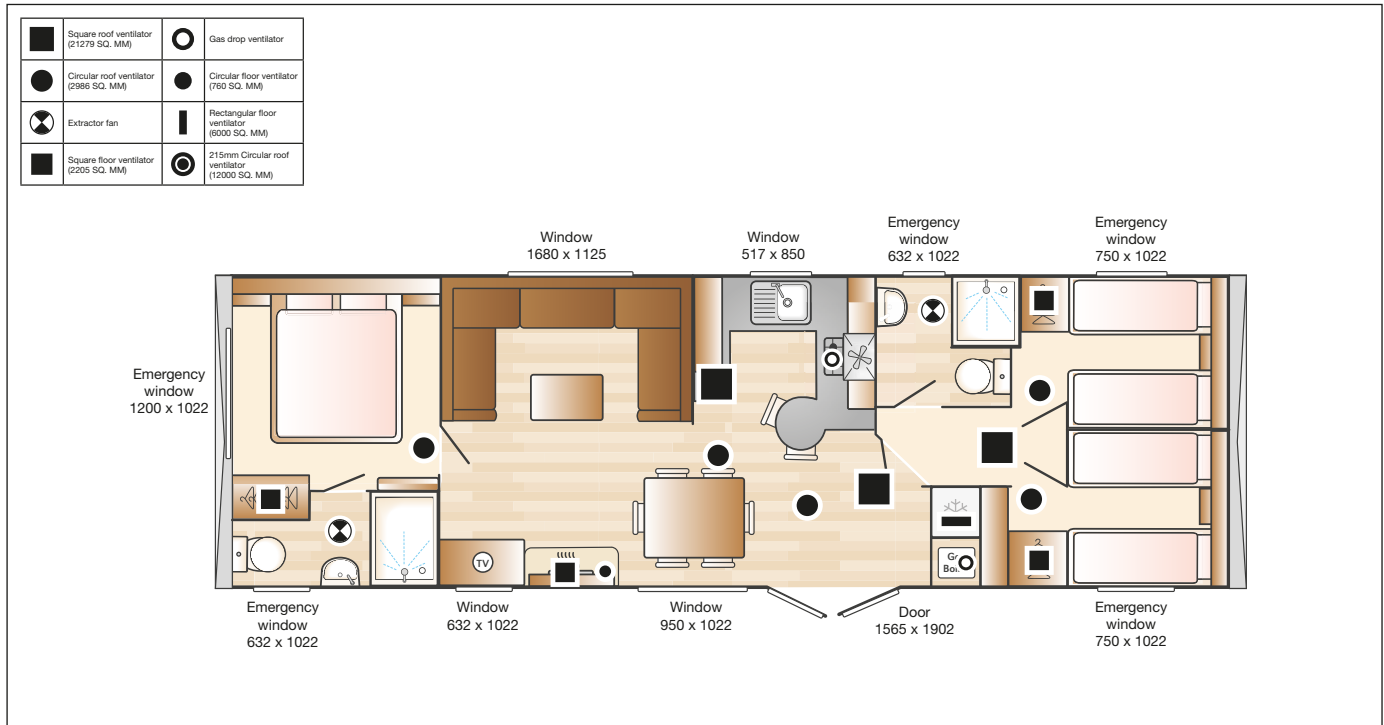

GENERAL LAYOUT SHOWING VENTILATION AND EMERGENCY EXITS

Serenity 38' x 12' 3 bed layout

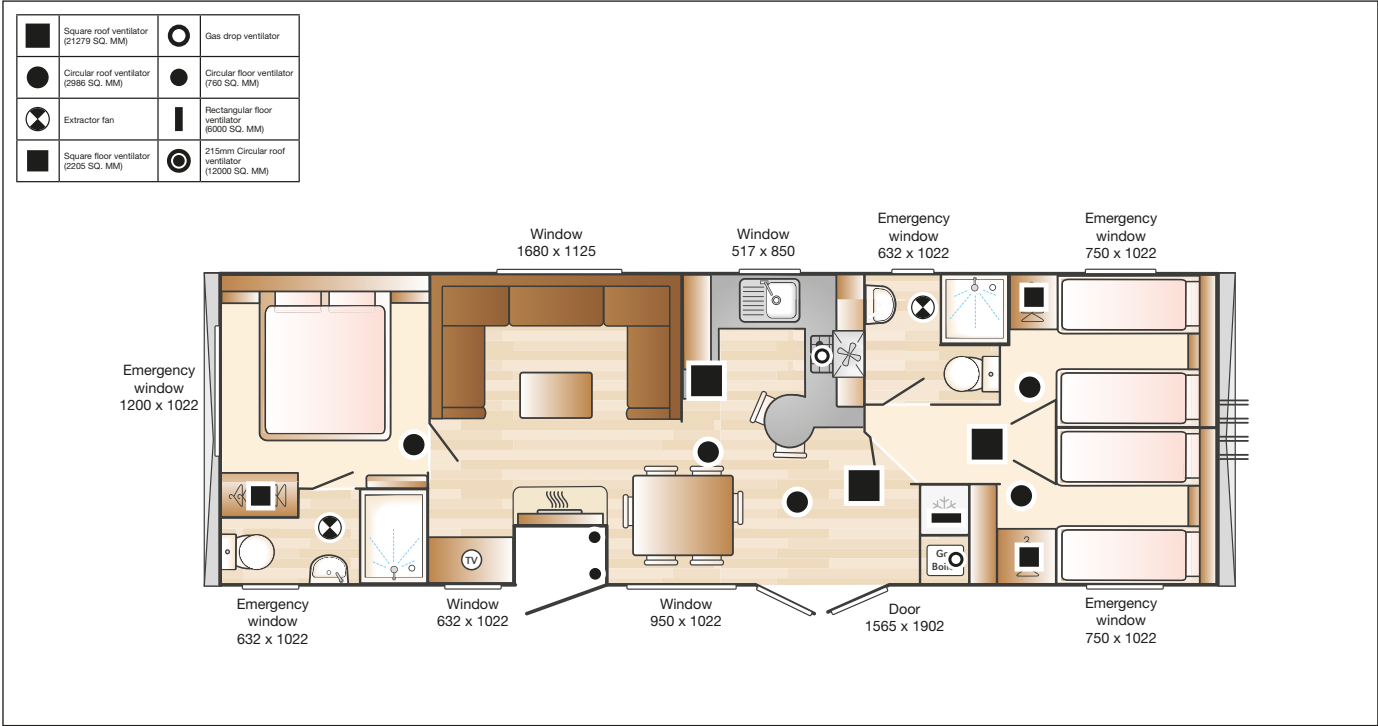

Technical Info

GENERAL LAYOUT SHOWING VENTILATION AND EMERGENCY EXITS

Coastal Retreat / Woodland Escape 38' x 12' 3 bed layout

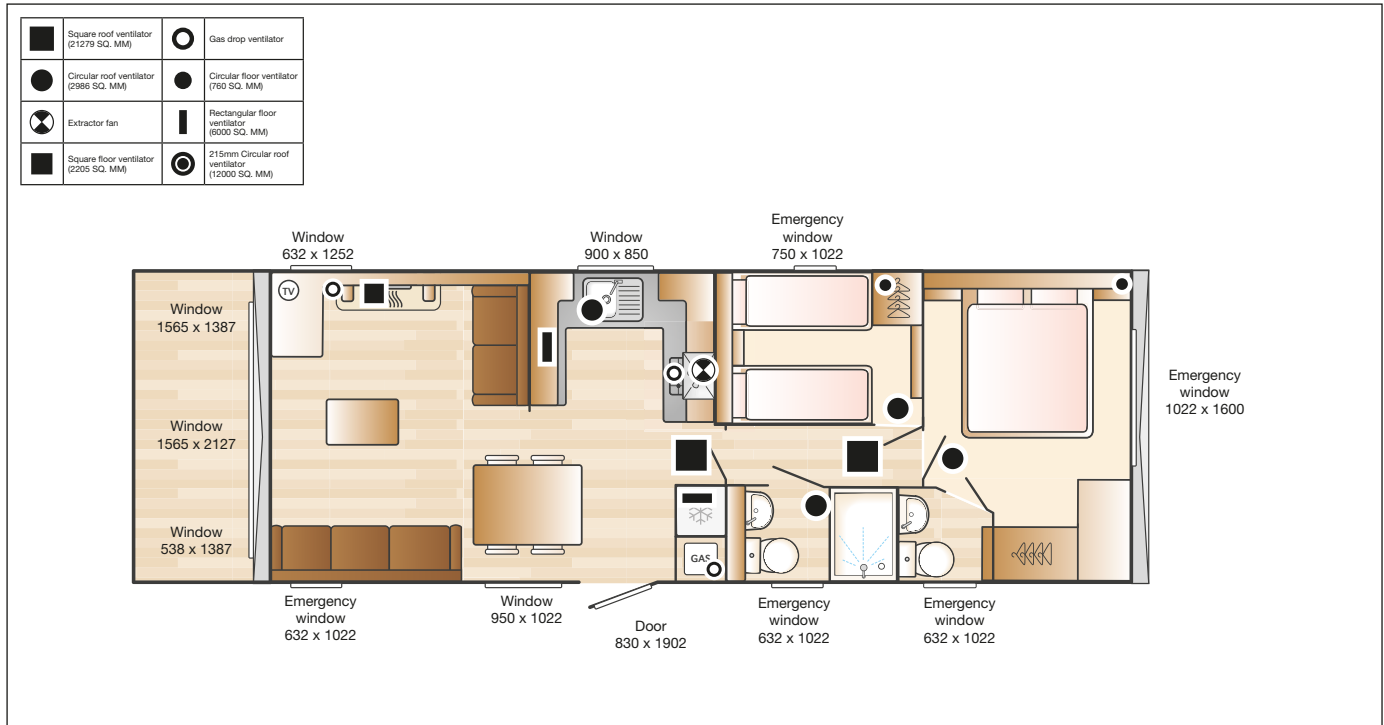

PLUMBING (TYPICAL WATER SYSTEM)

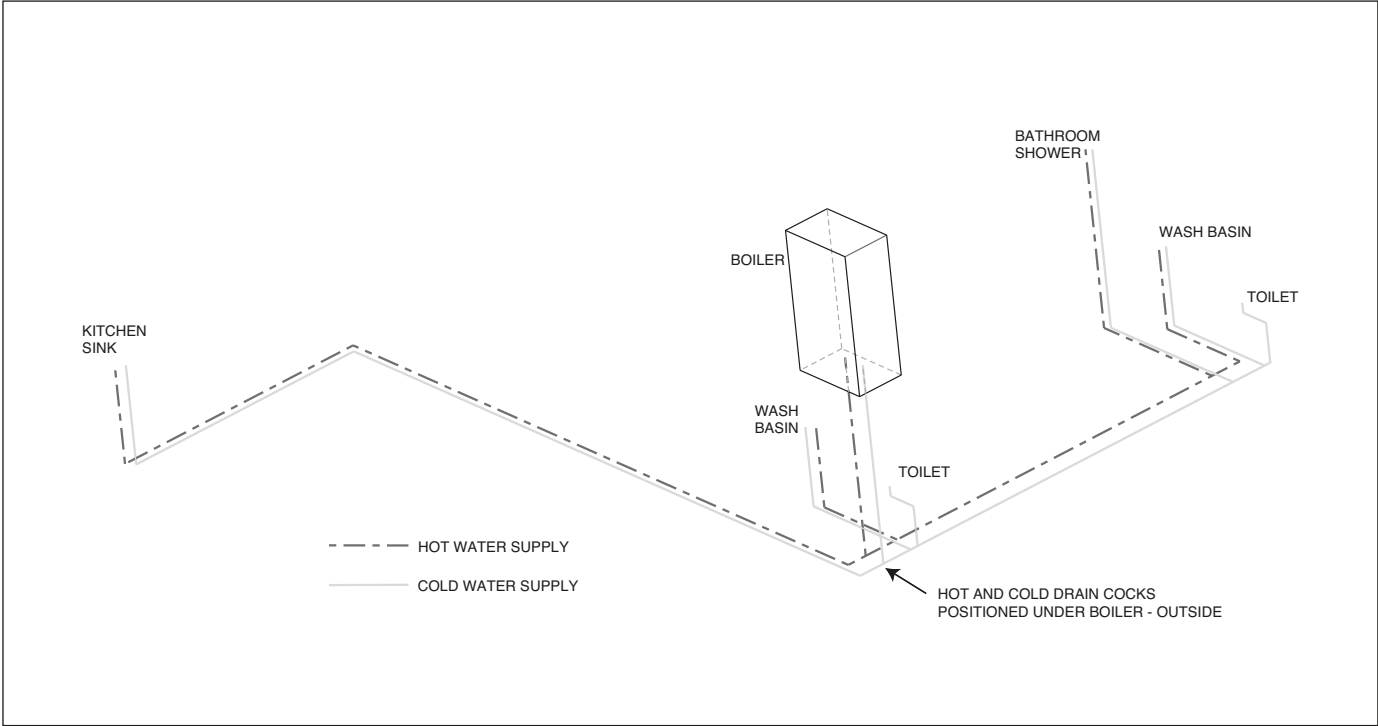

PLUMBING (TYPICAL HEATING SYSTEM)

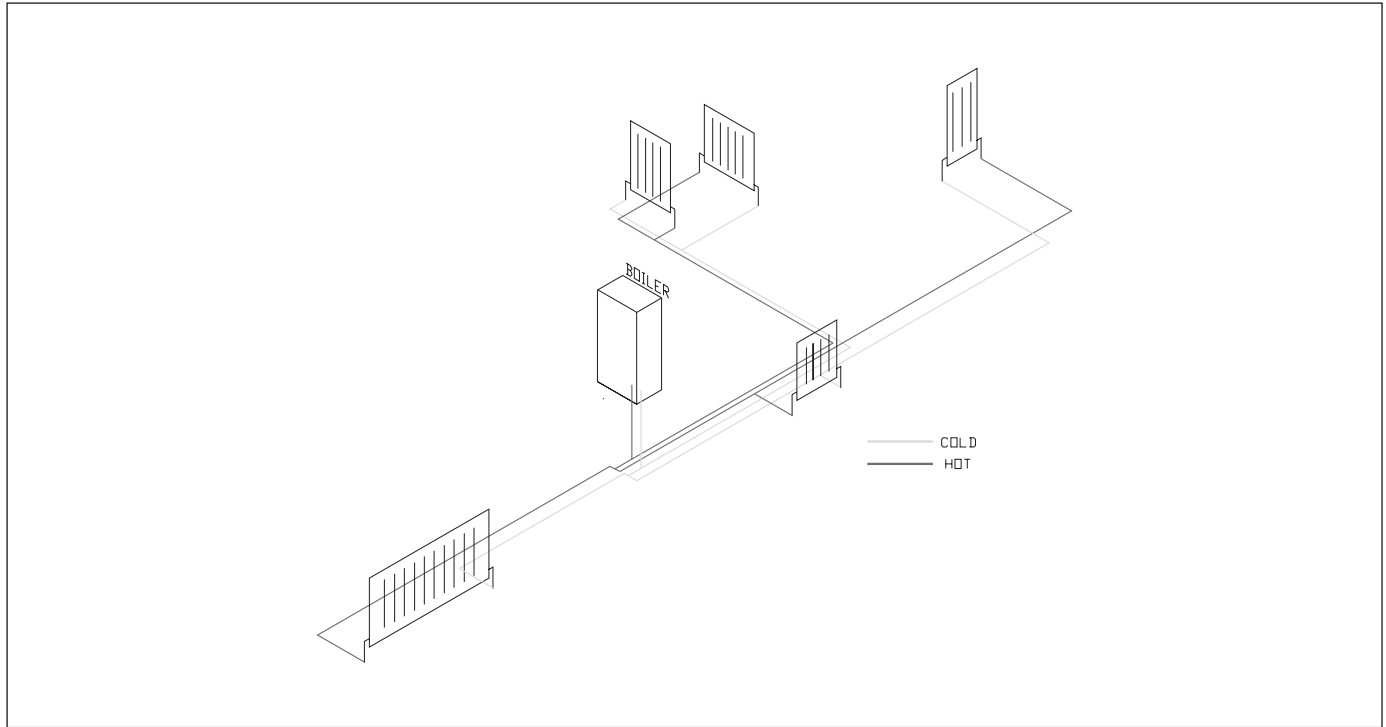

GENERIC SCHEMATIC

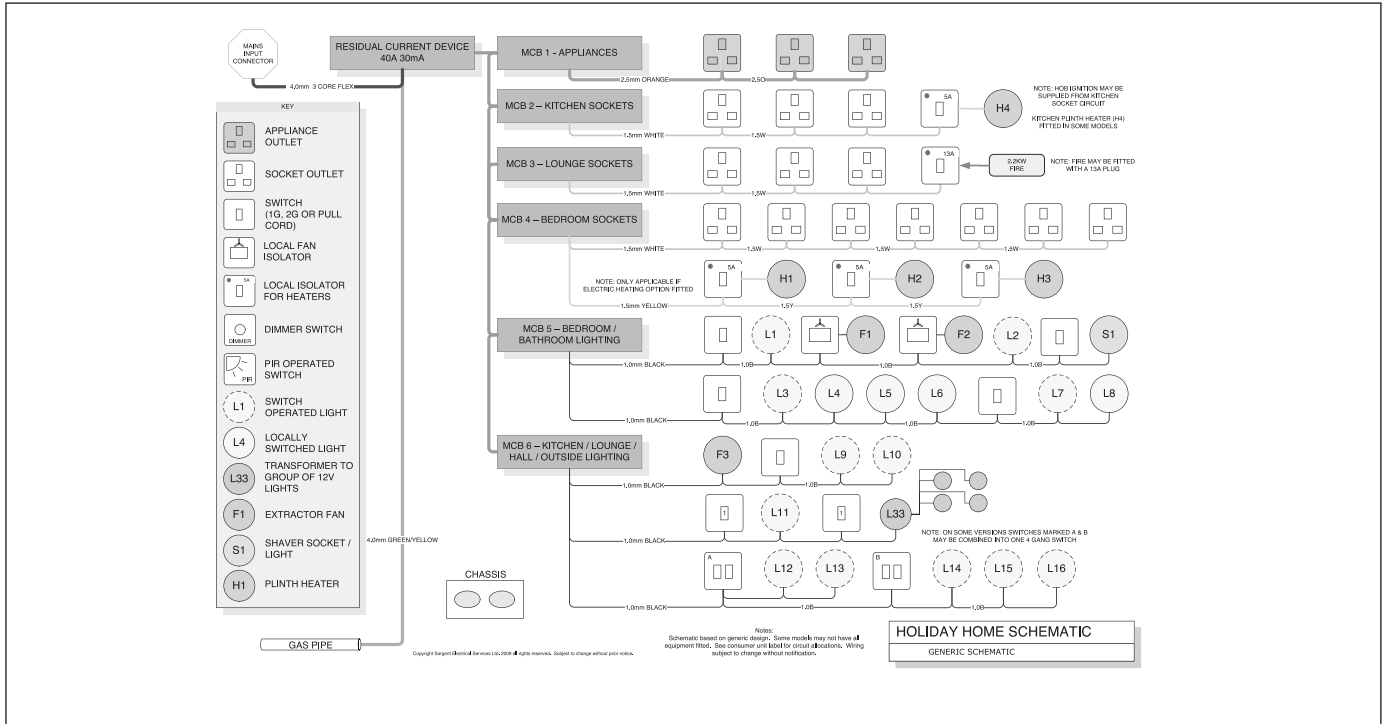

ALL ELECTRIC HEATING

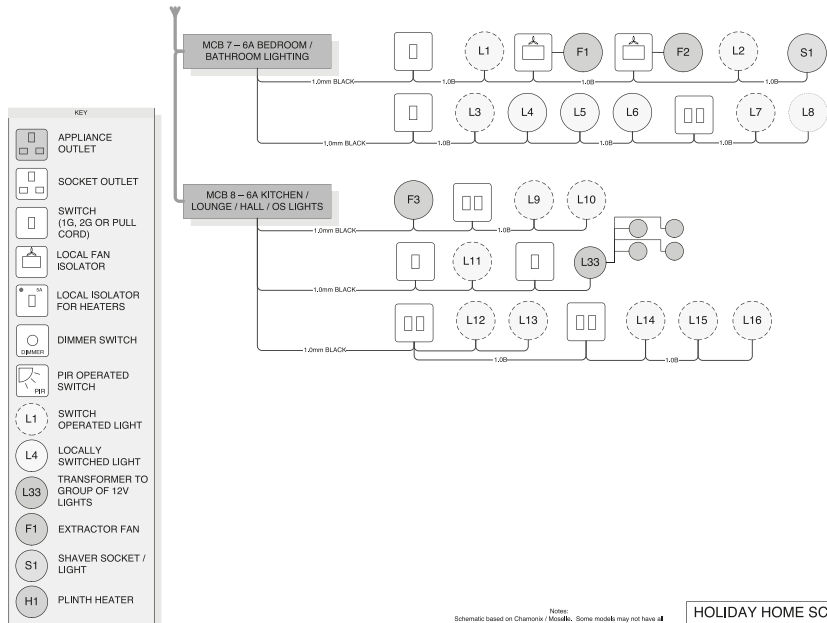

Copyright © Legend Electrical Services Ltd 2020. All rights reserved. Subject to change without prior notice.

Note:
Schematic based on Chameleon 100000. Some models may not have all equipment fitted. See consumer unit label for circuit allocations. Wiring subject to change without notification.

HOLIDAY HOME SCHEMATIC
ALL ELECTRIC HEATING – PART 2

Technical Info

CHAMPAGNE SCHEMATIC

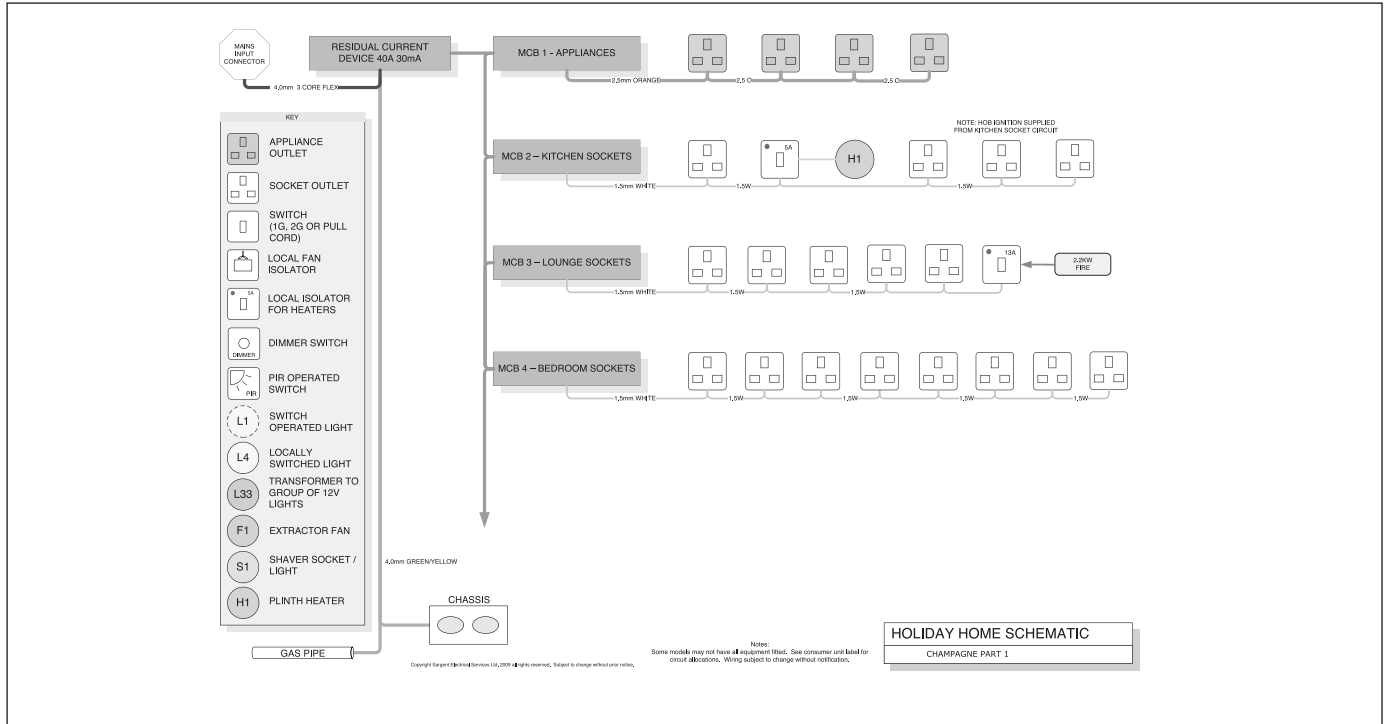

CHAMPAGNE SCHEMATIC

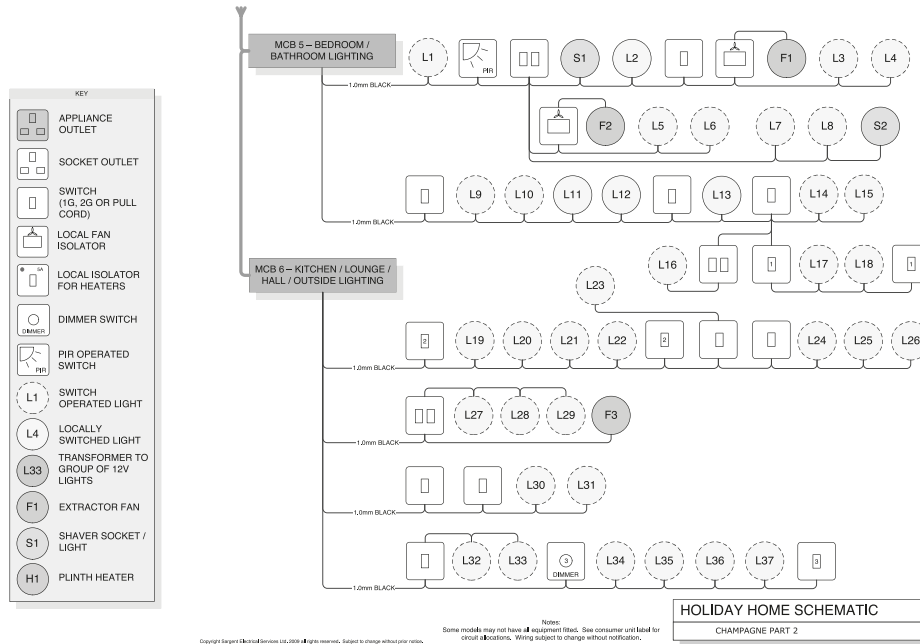

BORDEAUX / BURGUNDY CO-AX/AV SCHEMATIC

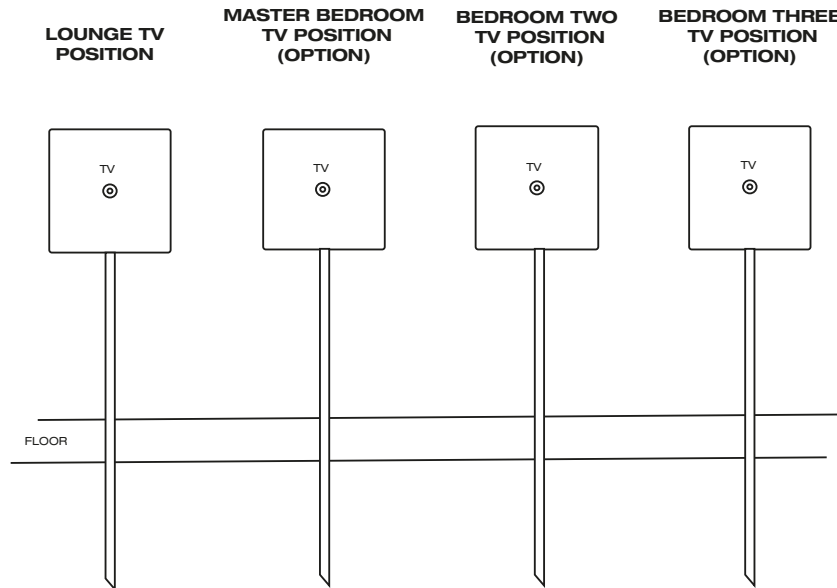

MOSELLE CO-AX/AV SCHEMATIC

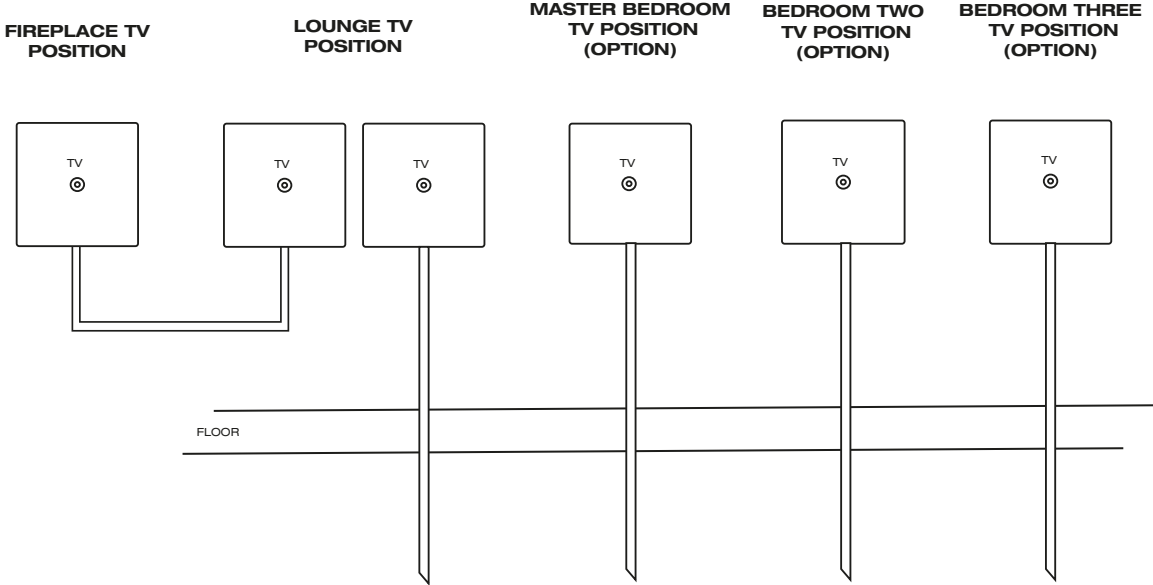

Technical Info

CHAMONIX CO-AX/AV SCHEMATIC

CO-AX / AV SCHEMATIC CHAMONIX

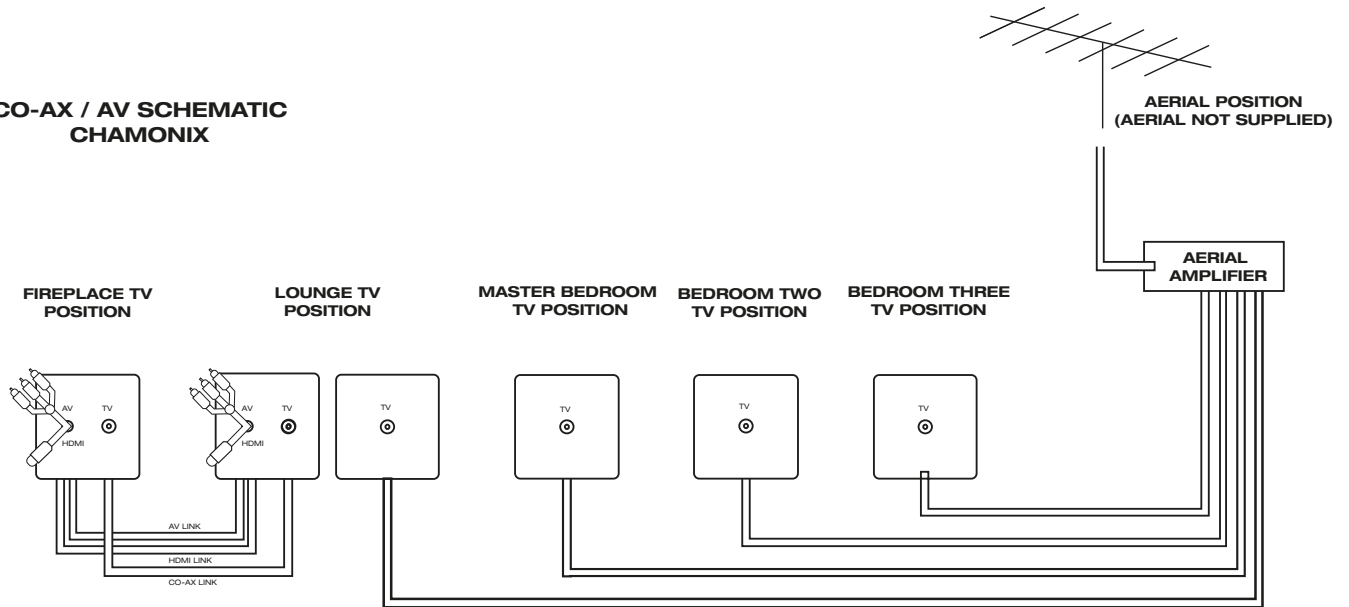

CHAMPAGNE CO-AX/AV SCHEMATIC

CO-AX / AV SCHEMATIC
CHAMPAGNE

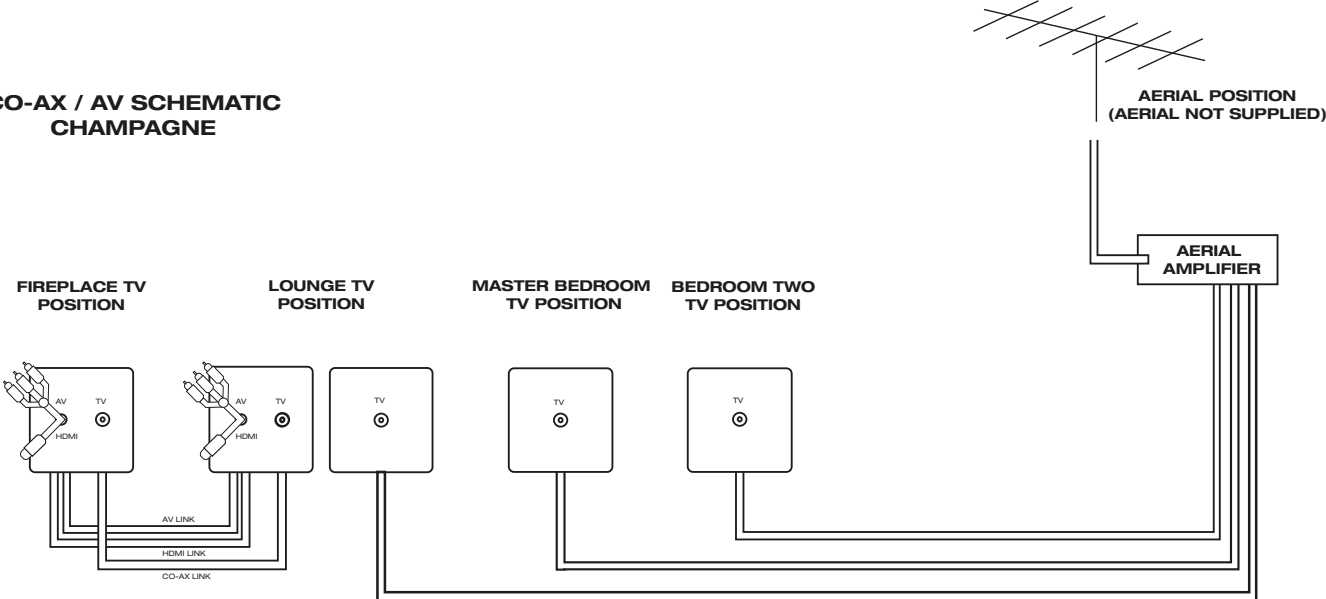

Technical Info

SERENITY / PROVENCE CO-AX/AV SCHEMATIC

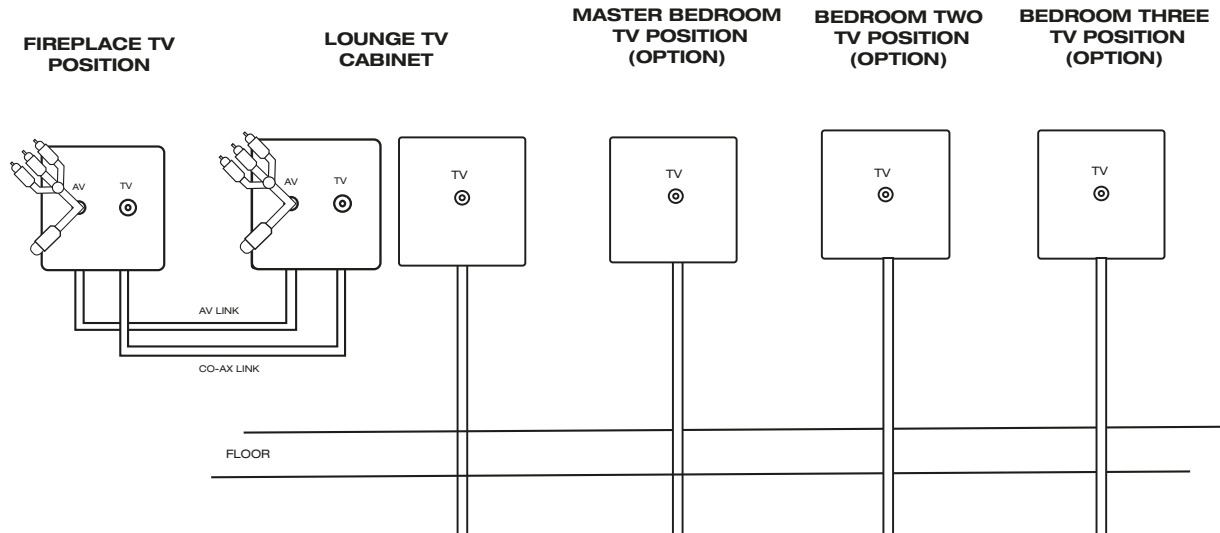

FAMILY RETREAT CO-AX/AV SCHEMATIC

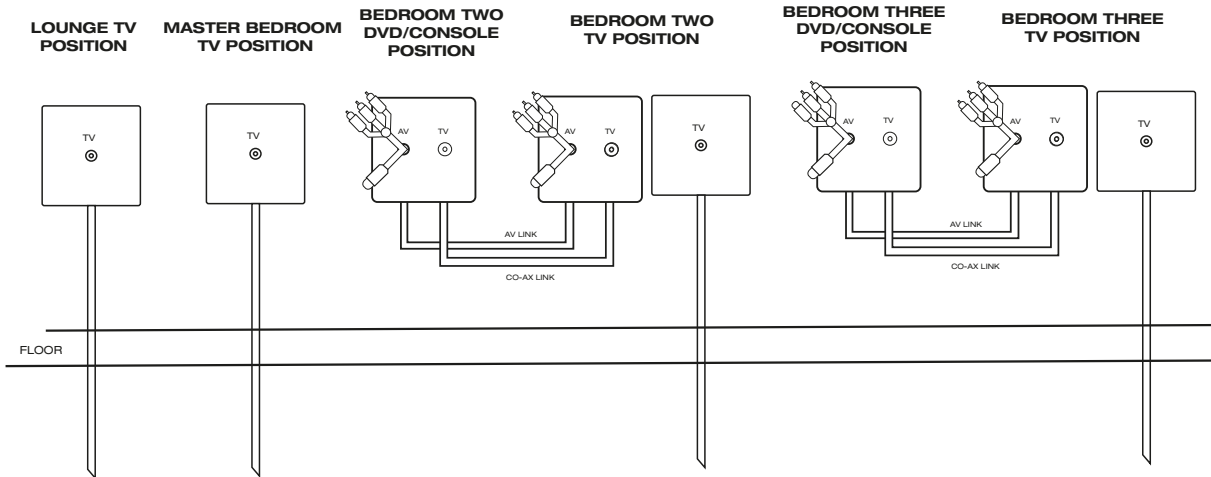

Index

- A**
- Aftersales support and service 10
 - Alignment and adjustment of doors 43
 - Anchors 15
 - Appliances 31
- B**
- Bathroom 37
 - Berths and bed sizes 56, 57
 - Blinds 28
 - Blockages 35
 - Bunk beds 28
 - Bunks 49
- C**
- Carbon monoxide - the facts 25
 - Carpet 41
 - Central heating 30
 - Chassis 34
 - Chassis specification 17
 - Cleaning 38
 - CO alarm 21
 - CO-AX/AV schematics 96
 - Cooker hood 31
 - Cooking 26
 - Craning 12
- D**
- Dishwasher 31
 - Door locks 36
 - Doors and windows 36, 41
- E**
- Electrical lounge fire/heater 31
 - Electrical Schematics 91
 - Electricity 25
 - Electrics 49
 - Emergency shut off points 22
 - Entrance door hinge and
lock adjustment 44
 - Exterior panels 35
 - External dimensions 54
 - External structure 34
- F**
- Fault finding 26
 - Fire extinguisher 21
 - Fire precautions 20
 - Fridge/freezer 31
- G**
- Gas 24
 - Gas cylinders 41, 50
 - Gas fire 31
 - Gas leaks 50
 - Gas oven 26, 31
 - Gas safety 24
 - Gas system 23
 - General layout 58, 65
 - General safety advice 20
 - Grill 26, 31
 - Gutters and downpipes 35
- H**
- Handles 36
 - Hob 26, 31
 - Hot water system 30
- I**
- Internal walls 49
- J**
- Jacking 13
- L**
- Lock keep adjustment 48
 - LPG 22, 50

M

- Microwave oven 31
- Model names 56, 57

N

- Night vents 36

O

- Owner's certificate 5

P

- Plumbing (typical heating system) 90
- Plumbing (typical water system) 89
- Pull out bed 28

S

- Security 41
- Siting 12
- Siting the caravan holiday home 14
- Smoke alarm 21
- Snow loading 16
- Snow precautions 36
- Support and holding down points 18
- Supporting the chassis 12
- Surface protection 49

T

- Taps 39
- Toilet/shower room 37

U

- Upholstery care 39

V

- Ventilation 27
- Ventilation and emergency exits ... 58, 65
- Vinyl flooring 41, 49

W

- Warranty 8
- Winterisation 51
- Wiring 25

