

CREATING SMILES FOR LIFE

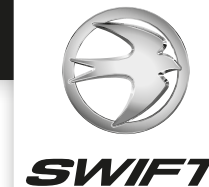

CREATING SMILES FOR LIFE



SWIFT GROUP

Dunswell Road
Cottingham
East Yorkshire
HU16 4JX

Tel: 01482 875740
Fax: 01482 840082
Email: enquiry@swiftgroup.co.uk

Swift Group Quick Start Guide

Touring Caravans

FIND OUT MORE AT SWIFTGROUP.CO.UK



Brochure



Layouts



Dealer



Video



Social

Issued July 2018
1430451



Contents

Pre-departure checks	1
Arrival on site.	2
Prime the cold water system.	3
Connect gas to caravan	4
Operate fridge	5
Operate Truma Combi boiler.	6
Operate Alde central heating system	8
Operate WHALE heating	10
Operate WHALE space heating	11

NB. If after following any of the steps in this guide a problem occurs, please first consult your main handbook for further information, and if problems still persist contact your supplying dealer.

The main caravan owners handbook can be found on the Swift Group website:

www.swiftgroup.co.uk/owners/handbooks



PRE-DEPARTURE CHECKS

Loading

Ensure all loose items are secured and doors, lockers and windows are closed.

Load heavy items at floor level over the caravan axle.

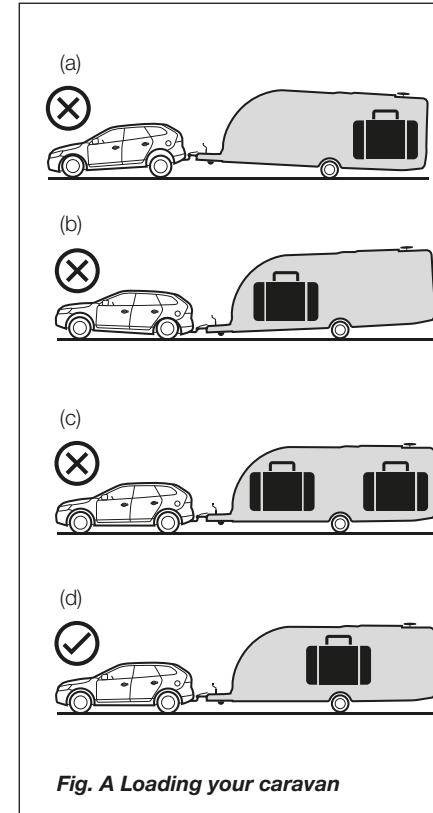

Fig. A Loading your caravan

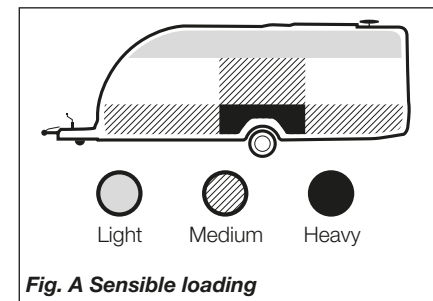

Fig. A Sensible loading

Tyre pressures

Check all tyre pressures are correct.

Hitching up

Couple up the caravan and ensure the green band indicating that a proper connection has been made is visible.

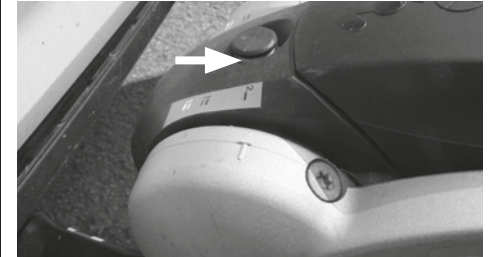

Ensure breakaway cable is attached.



Align the 13 pin plug with the receiving socket on the tow vehicle.



Insert & twist road lighting connector (13 pin plug)

Check all road lighting is operating correctly.

ARRIVAL ON SITE

Siting, uncoupling and levelling

Locate a suitable pitch. Check and observe site regulations

Apply the caravan handbrake



Lower the jockey wheel to the ground (if not already done during levelling)



The jockey wheel can be used to help level the caravan

Disconnect the breakaway cable and road lighting plug

Lower the corner steadies until they make firm contact with the ground



NOTE: Do not use corner steadies to lift or level the caravan.

PRIME THE COLD WATER SYSTEM

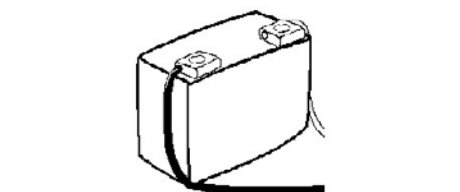

1. Connect leisure battery.

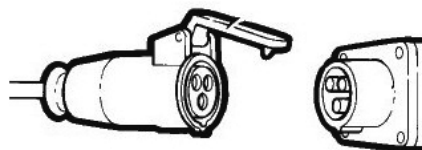

2. Plug 230V supply into caravan then into site supply (if appropriate).



3. Press black isolator button on front of power supply unit to turn system on. (Button in)

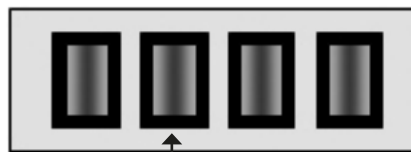

Charger

4. Press green button on power supply unit to switch on charger.



5. Press power button on control panel (usually above entrance door).

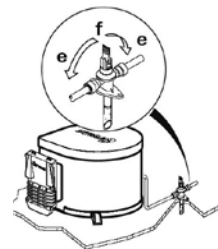
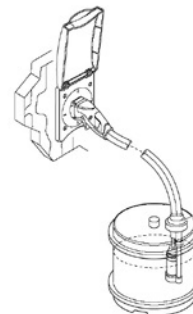

Fill external container and position supply of water close to external connection. If two water inlets are present on the side of the caravan, use the lower inlet (upper is used to fill the water tank when fitted).

Submerge supplied external hose / pump in container, ensuring the end of the hose is below the water level. Plug the external hose / pump into the side of the caravan.

Locate safety/drain valve close to Alde or Truma heating appliance, and ensure handle is in horizontal position (e).

For Whale heating, locate yellow drain valve in base of wardrobe and rotate anti-clockwise.

Close all taps except kitchen sink tap, which should be set to 'hot' position.

Press pump button on control panel, and wait until water is flowing from kitchen tap (this may take a few minutes).

Set kitchen tap to 'cold' and again wait, until water is flowing cleanly.

For vanity and shower taps / mixers, open to hot and then to cold until again water is flowing cleanly at each outlet.

CONNECT GAS TO CARAVAN

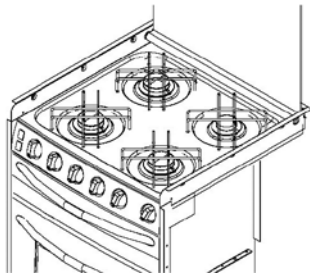
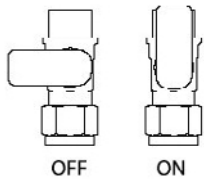
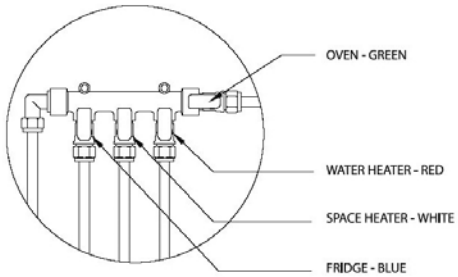
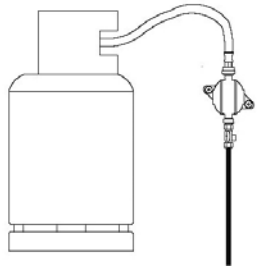

Position the gas bottle and tighten the securing straps, then fix hose to regulator, and tighten using spanner. Fix other end of hose to gas bottle, again tightening using spanner.

Turn valve on top of gas bottle to turn on gas supply, and if regulator is 'Crash Sensor' or 'Crash Safe', follow steps described on Yellow label close to regulator, to reset safety features.

Locate gas isolation valves, which may be assembled onto a manifold or be in the format of a separate tap fitted close to an appliance.

Turn each tap to the 'ON' position

Move to hob/oven. Open glass lid fully.

Press igniter on hob, turn one burner control to 'ON' position, and depress that control.

After a short while burner should light.

Gas should now be available at all appliances.

OPERATE FRIDGE

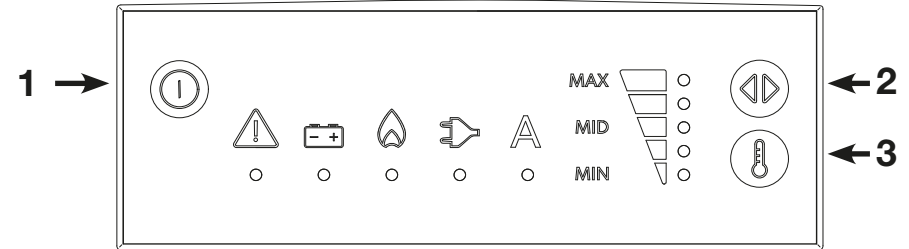





TURN ON

Press the power button (1) for approx. one second to switch on the fridge. Pressing and holding the button (1) for approx. one second again, will switch off the fridge.

Choose energy source.

Press button (2) to move between the energy source choices. From left to right these are:

-  12v (from towing vehicle)
-  Gas
-  230v (mains hook up)
-  Automatic selection of available source

An LED will illuminate below the corresponding symbol to confirm the chosen energy source.

Choose temperature:

Press button (3) to choose a temperature. With all indicators illuminated, maximum cooling will occur.

After a short time the fridge will begin to operate. If a problem occurs (for instance no gas when gas energy source is selected), then the LED below the warning symbol will illuminate. Please note; allow the refrigerator to run for at least two hours, or ideally run the refrigerator over night, to cool to a suitable temperature for storage of food.

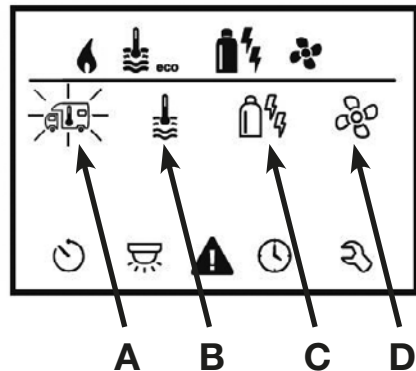

The Truma Combi dual purpose boiler can be used for:

- a) Water heating using gas or mains electricity as an energy source.
- b) Space heating using gas or mains electricity as an energy source, with or without water in the system. (If space heating is used with water in the system, then the water will also be heated to an unspecified temperature).

This guide details basic settings only, for further details, and use of the Swift Command system to control heating, please see main handbook and links to external sources for further information.

Electrical isolation switch

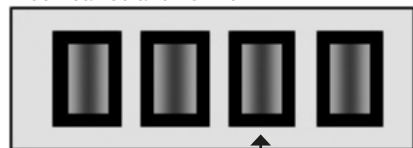

Heating/
Hot water

The Orange 230V / Mains isolation switch on power supply unit must be ON / illuminated for electric operation of the Combi.

Turn heating system ON:

Press and hold the rotary control (8) for 3 seconds to turn the system ON – the display will alternate between time and temperature displays. Press the rotary control (8) to adjust settings – the display will then show the symbols row (3).

Pressing and holding the rotary control (8) will also switch the heating system OFF.

Choose required room temperature:

Rotate the control (8) until the vehicle symbol (A) is flashing, then press the rotary control (8) to allow adjustment of room temperature. Rotate the control (8) to select the preferred room temperature, or rotate anti-clockwise to 'OFF' if room heating is not required. Press the rotary control (8) to confirm this selection.

Choose water heating settings:

Rotate the control (8) until the thermometer symbol (B) is flashing, then press the rotary control (8) to allow adjustment of water heating settings. Turn the rotary control (8) to select either 40°C, 60°C or Boost, or rotate anti-clockwise to 'OFF' if room heating is the priority, and water heating is not important. Press the rotary control to confirm the selection.

Choose energy source:

Turn the rotary control (8) until the energy symbol (C) is flashing, then press the rotary control (8) to allow the adjustment of energy selection.

Turn the rotary control (8) to select one of the available choices, then press the rotary control to confirm. Choices are:

- GAS (gas only)
- EL1 (0.9kw electric element)
- EL2 (1.8kw electric element)
- MIX 1 (Gas + 0.9kw electric element)
- MIX 2 (Gas + 1.8kw electric element)

Choose fan settings:

Turn the rotary control (8) until the fan symbol (D) is flashing, then press the rotary control (8) to allow the adjustment of fan settings. Turn the rotary control (8) to choose from one of the available options, then press the rotary control (8) to confirm. Choices are:

- OFF** - No fan operation required. Only possible when no room temperature is selected.
- Vent** - Fan operates to circulate cold air only. Only possible when appliance is cold (No water or space heating)
- Eco/High** - Fan limited to either low (Eco) or high speed. Actual fan speed will vary according to heating system requirements.
- Boost** - Maximum fan operation. Only possible when there is a large difference between room temperature and preferred room temperature.

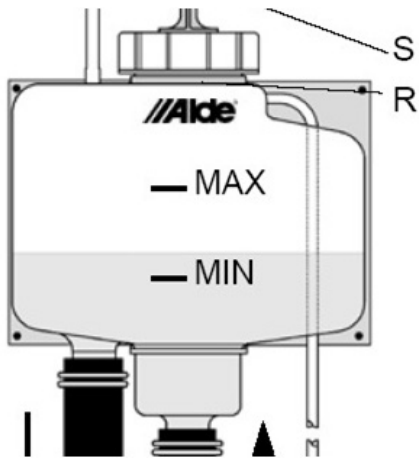

The Alde 3020HE central heating system can provide hot water and room heating, from gas and/or mains (230v) electric energy sources. The room heating can be used with or without water in the heater - if water is present, then the water will also be heated to an unspecified temperature..

Before using the central heating system check that the level of 'glycol' fluid which is used to heat the radiators, is between the min and max levels on the header tank.

The Alde control panel is located near the entrance door, and is used to select energy source and water / room heating operations. This guide details basic settings only, for further details, and use of the Swift Command system to control heating, please see main handbook and links to external sources for further information.

Electrical isolation switch

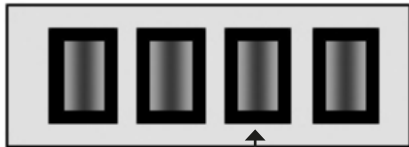

Heating/
Hot water

The Orange 230V / Mains isolation switch on power supply unit must be ON / illuminated for electric operation of the Alde central heating system.

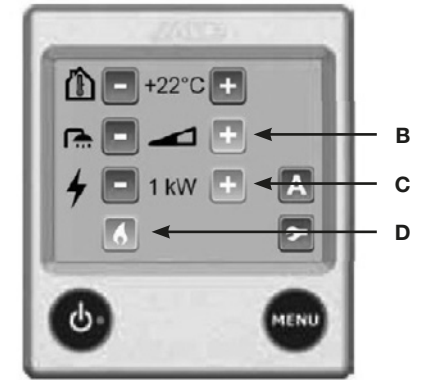

Turn heating system ON:

To turn the panel on, press the power button (1). The heating system will return to previously used settings, until adjustments are made. Press the menu button (2) to display a screen showing heating system options. Please note after a short time the display will switch back from the menu settings to the standby screen, if no further areas of the screen are touched.

Pressing and holding the power button (1) will switch the heating system OFF.

Choose required room temperature

Using the touch screen display, press the + and - buttons on row A to select preferred room temperature. The preferred room temperature is displayed between the + and - buttons.

Choose water heating settings

Using the + and - buttons on row B select preferred water temperature. The bar chart between the + and - buttons shows the temperature selected, from no preferred temperature (empty) to high temperature or boost (fully Black).

Choose energy settings - Electric operation

Using the + and - buttons on row C select 1kw, 2kw or 3kw electric elements.

Choose energy settings - Gas operation

Press the flame button (D) to turn on (Green) or OFF (Blue) the gas operation. It is possible to combine differing levels of 230v operation, with gas operation.

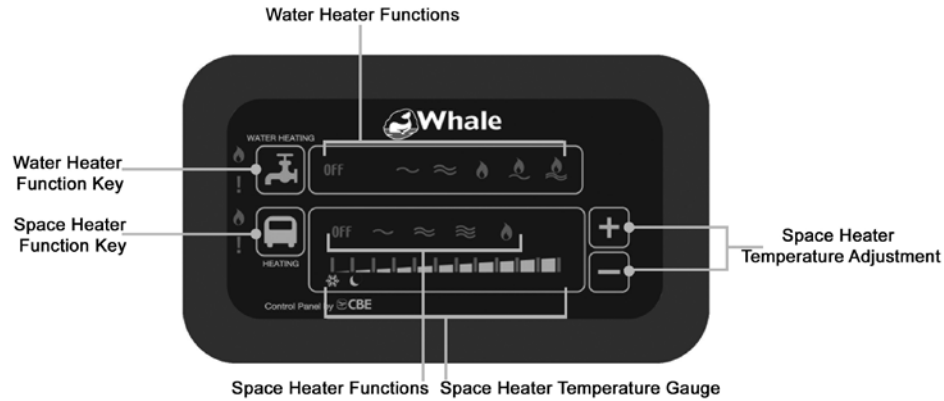

The Whale Duo control panel allows operation of the Whale space heater and Whale water heater from a single control panel. This guide describes basic operation, for further detail, and to operate the Whale space heater and water heater from the Swift Command system, please see main handbook.

It is possible to use space heating and water heating separately, so space heating can be used without priming the water system. It is possible to select gas or electric (230V) operation for either appliance.

Dual fuel operation of the water heater is also possible, see main handbook for details.

The water heater should not be switched on if the water system is not primed.

Electrical isolation switch

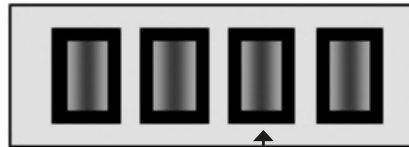

The Orange 230V / Mains isolation switch on power supply unit must be ON / illuminated for electric operation of the Whale space heater.



Ensure the water system is primed, as described earlier in this guide.



On the Duo control panel, press the Space Heater ON button and the Power Settings indicators will illuminate one at a time to show which power level has been selected.



For 500w electric element



For 1000w electric element



For 2000w electric element



For gas operation

Choose required room temperature:



When a Power Setting has been selected, select a target room temperature using the *Temperature Up/Down* buttons. Press the *Temperature Down* button to move the Space Heater Temperature LED indicator to the left, and set a lower target temperature, and press the *Temperature Up* button to move the LED indicator to the right, and set a higher target temperature.



Turn Water Heater ON and choose energy source:



On the Duo control panel, press the Space Heater ON button and the Power Settings indicators will illuminate one at a time to show which power level has been selected.



For 750w electric element



For 1500w electric element



For gas operation



For combined 750w and gas operation



For combined 1500w and gas operation

