



SWIFT

SWIFT GROUP OWNER'S HANDBOOK

TREKKER VAN CONVERSION

Issued September 2024

Part No. 1452757

Dear owner

Thank you for deciding to buy one of our new motorhomes.

We are sure you will enjoy many happy hours in it and we hope the information and hints in this handbook will heighten your enjoyment.

The handbook has been designed to give you a general guide to the care, use and maintenance of your motorhome. Whether you are a new or an experienced motorhomer the hints will help to protect your investment.

The information contained will answer most of your queries, but if there are any aspects which are not covered please consult your appointed dealer. We would suggest you make a note of your dealers name and contact information below.

Important - please quote the base VIN (vehicle identification number) in all correspondence with your dealer or Swift Group Limited (Swift), this can be found at the bottom corner of the front windscreen or on the inside of the passenger door pillar. The Swift manufacturers plate also contains the VIN and is situated on the inside of the passenger door pillar.

All the illustrations and descriptive matter in this handbook are intended to give a general idea of the motorhome. Changing market and supply situations may prevent us from maintaining the exact specification details in this handbook. We therefore reserve the right to alter specifications as materials and conditions demand.

Dealers are not agents of Swift Group Limited and have absolutely no authority to bind Swift Group Limited by any express or implied undertaking or representation.

Online Handbooks

Throughout the season, specifications and equipment details contained within this handbook may change. Please refer to our online handbooks (www.swiftgroup.co.uk) for the most up-to-date version of your handbook.

Handbook Definitions

Customers should note that this handbook contains general information for the use and care of your product and the Technical Handbook, which contains technical information, weights and dimensions of your product.

Happy touring!

Dealer Name:

.....

Telephone Number:

.....

E-mail:

.....

VIN:

.....

Sales Tel:

.....

Service Centre Tel:

.....

Parts Tel:

.....

First Service Due:

.....

Contents

1. Warranty	5
2. Motorhome code	13
3. Preparing for the road	17
4. En-route	27
5. Safety and security	31
6. Arrival at site	35
7. Connecting services	37
8. Preparing for the road	57
9. Fitted equipment	81
10. Motorhome Care	107
11. Technical information	119
12. Useful information	129

1. Warranty

1.1 Panel Van Conversion Motorhome Warranty	6
1.2 My Swift Life customer portal	8
1.3 Supplier contacts	9
1.4 Annual service / inspection record	10

1.1 Panel Van Conversion Motorhome Warranty

All the illustrations and descriptive matter in this handbook are intended to give a general idea of the motorhome. Changing market and supply situations and our policy of continuous product development may prevent us from maintaining the exact specifications detailed in this handbook. We therefore reserve the right to alter specifications as materials and conditions demand.

Dealers are not agents of Swift Group Limited ("Swift") and have absolutely no authority to bind the manufacturer by any express or implied undertaking or representation.

Note: To register your warranty, please register for My Swift Life, the registration process can be accessed via: www.swiftgroup.co.uk, by doing so you are agreeing that you have had the details of the warranty and the annual service arrangements fully explained. This in no way affects your statutory rights under the Consumer Rights Act.

Your Panel Van Conversion has four warranties:

Base Vehicle Warranty – provided by Ford

Your vehicle is a panel van conversion motorhome which utilises a Ford base vehicle. For a panel van conversion motorhome, Swift takes a panel van as supplied by Ford and fits out the interior of the van for habitation. Ford provides a manufacturer's warranty for the base vehicle as supplied to Swift by them.

For any issues with the base vehicle warranty please contact your local Ford dealer. This Motorhome Warranty does not cover any parts of your motorhome that are covered by the Ford manufacturer's warranty. Your base vehicle warranty is subject to the terms and conditions contained in the Ford handbook supplied with the base vehicle and the vehicle must be serviced in accordance with Ford requirements.

SuperSure Warranty – provided by Swift

For all parts or fittings of your panel van conversion motorhome other than the Ford base vehicle, Swift will repair (or at its option, replace) any defective parts or fittings for 3 years from the date of purchase (or hire purchase) subject to conditions, terms and exclusions below.

Panel Van Conversion Body Shell Warranty – provided by Swift

Swift will repair (or at its option, replace) any defects with the panel van conversion to the body shell for 3 years from the date of purchase (or hire purchase), subject to the conditions, terms and exclusions below.

This Motorhome Warranty does not cover any parts of your motorhome that are covered by the Ford manufacturer's warranty.

Conditions for the SuperSure and Body Shell Warranties

1. You must ensure that the habitation part of your motorhome has an Annual Service (see clause 2 below) within 90 days before or 60 days after each anniversary of the original date of purchase. In order to preserve your SuperSure and Body Shell Warranties the third Annual Service must, however, be carried out before the expiry of the 36 month period from the original date of purchase. If you have not performed an Annual Service then Swift will not be obliged to perform any work under the applicable warranty. Original VAT invoices must be retained as proof that Annual Service have been carried out.
2. The Annual Service on the body shell and habitation area must be carried out in accordance with the requirements in this handbook. You will be responsible for any charges made for an Annual Service.
If the Annual Service is performed by an authorised Swift Group Service Centre then Swift warrants that the Annual Service has been performed correctly. If the Annual Service is performed by an unauthorised repairer or service centre then if the Annual Service has not been performed in accordance with the requirements in this handbook and/or work has been performed on your motorhome that is defective or faulty, then Swift will not be obliged to perform any work under this Warranty (insofar as it relates to defective or faulty work or defective Annual Service).
3. The benefit of the SuperSure and Body 3. All new motorhomes must be registered with Swift within 6 weeks of purchase as new.

4. The benefit of the SuperSure and Body Shell Warranties may be transferred to a new owner if the motorhome is re-sold, provided that the motorhome has been serviced in accordance with the requirements of this handbook, and details of the change of ownership have been supplied to Swift using the change of ownership form set out in this handbook as soon as reasonably practicable after the change.
5. If any repairs are identified as being necessary to the body shell or habitation areas during an Annual Service or otherwise, Swift will only pay for Warranty work performed by an authorised Swift Group Service Centre. The motorhome must be made available to an authorised Swift Group Service Centre within 6 weeks of the date the repair need was identified for the work to be carried out. The cost of transporting, towing or moving the motorhome by any means to or from the place of repair is the responsibility of the owner.
6. The SuperSure and Body Shell Warranties only apply to motorhomes purchased and used primarily within the UK. Please refer to the Ford handbook for use of the base vehicle outside the UK.

Terms

7. The Body Shell Warranty covers any defect with the joints and seals of the panel van conversion (excluding elevating roof and roof tent). This includes body leaks, delamination of floors, and water ingress through any permanently sealed seam joints which relate to the conversion of the panel van. This Motorhome Warranty does not cover any parts of your motorhome that are covered by the Ford manufacturer's warranty.
8. In the first 12 months the SuperSure Warranty will cover any defect other than those specified in the Exclusions below.

9. In the years 2 and 3 the SuperSure Warranty will only cover any defect with the following components:

- **Electrical System:** PSU, battery charger and interior lighting units (excluding bulbs).
- **Water system:** water heater, fresh water tank, water pump, water gauges, taps and shower head.
- **Cooker:** the cooker unit including grill, oven, burners, igniter, and flame failure device.
- **Refrigerator:** gas igniter, flame failure device, door seal condenser, gas control valve, 12v and 230v heater elements, gas thermostat, 230v thermostat and 230v temperature control switch.
- **Cassette Toilet:** the cassette toilet (excluding seals, valves and glands).
- **Heating system:** thermostat, motor, switches, control unit, gas heater, flame failure device and igniter (excluding ducting and fittings).
- **Windows:** the functionality of the opening and closing system (stays, handles and catches) and a warranty against the cracking of the acrylic, Excludes fading.
- **Upholstery:** zips, seams and colour fastness.

In years 2 and 3, any defect specified in the Exclusions will not be covered. Exclusions

Exclusions

10. Swift shall not be liable under the SuperSure and Body Shell Warranties for any defect related to or arising from the following:
 1. The failure of a component for reasons of fair wear and tear;
 2. Damage resulting from freezing, fire, over-heating or accidents (whether caused by the user or a third party);
 3. Misuse of any component;
 4. Normal deterioration, corrosion, intrusion of foreign or harmful bodies, lack of servicing or negligence of any person other than Swift which causes stoppage of or impairment to the function of any component of the motorhome;
 5. Replacement of parts which have reached the end of their effective working life because of age and/or usage;
 6. Cleaning or adjustment of any assemblies;
 7. Damage caused by any abrasive cleaners

8. Cosmetic finishes to kitchen sinks, cooker tops, vanity units, shower trays; and/or
9. Routine maintenance items which are part of the annual service including lubricants, rubber gas hose, the cleaning of the heater and fridge flues, the replacement of gas jets, the resealing and/or replacement of shower room sealant, and the adjustment and lubrication of locks.
10. Should you have an enquiry or require assistance with a problem, we hope that this guide will be of assistance to you.
11. In addition to the exclusions above, in years 2 and 3 of the SuperSure Warranty Period, Swift Group Limited shall not be liable under this Warranty for any defects related to:
 - Any microwave
 - Factory fitted leisure battery after 12 months of date of purchase
 - Elevating roof and roof tent after 12 months from date of purchase.
12. Swift shall also not be liable under the SuperSure, and Body Shell Warranties if the motorhome has been neglected, misused, modified or used for hire or reward or if the identification marks (chassis/VIN numbers) have been removed or defaced. The motorhome will be deemed to have been neglected if it has not been serviced and maintained as stated in this handbook or any repairs being identified as necessary at an Annual Service or by a Swift Group Service Centre have not been carried out in a reasonable time.

You have legal rights under UK law governing the sale of consumer goods. This Warranty does not affect your legal rights.

The name and address of the Warranty provider is:

Swift Group Limited, Dunswell Road,
Cottingham, East Yorkshire, HU16 4JX

To make a claim under this Warranty, contact the Swift Group Dealer which supplied your motorhome. Alternatively, details of your nearest authorised Swift Group Service Centre are included on the website www.swiftgroup.co.uk

Change of Ownership

You can transfer the remainder of any three year 'Supersure warranty' and the three year 'Body shell' warranty, details of how to do this can be found at the rear of this handbook.

1.2 My Swift Life customer portal

You have access to an online system which is specific to your new panel van.

You should automatically receive an invitation to register for the My Swift Life portal, if you did not receive this, please visit www.swiftgroup.co.uk and select register for My Swift Life.

What to do if you Require Assistance

Should you have an enquiry or require assistance with a problem, we hope that this guide will be of assistance to you.

Please follow these steps:

1. Check the Owners Handbook, paying particular attention to the fault finding advice at the back of the book.
2. Contact your supplying dealer for assistance.

If you need to contact Swift Group Limited, please be aware of the following:

1. When contacting Swift Group, please quote your name, postcode and VIN (Vehicle Identification Number). This can be found at the bottom of the front windscreen and on the passenger door B pillar.
2. In most instances, the Customer Service Team will involve your dealer in resolving the issue you are experiencing.
3. Check our website www.swiftgroup.co.uk and enter the help and advice section which provides answers to frequently asked questions and how to contact us.
4. If you are contacting the company by email, letter or fax, the Customer Service Team will respond to you within five working days from the date of receiving the correspondence.
5. Please be aware that Swift Group Limited cannot send parts direct from the factory. In all cases, without exception, your dealer must place the order for you.

1.3 Supplier contacts

A number of Swift Group suppliers manage their own Technical and Warranty related queries. Where a customer has a question relating to a product manufactured by a company listed below, we would advise that the first contact should be directly with them.



Sargent Electrical Services
Unit 39, Tokenspire Business
Park, Beverley, East Yorkshire,
HU17 0TB
Phone: 01482 678981
Fax: 01482 678987
E-mail: support@sargentltd.co.uk

<https://sargentltd.co.uk>



Truma UK Ltd.
Park lane, Dove Valley Park,
South Derbyshire, DE65 5BG
Phone: 01283 586020
Fax: 01283 586029
technical@trumauk.com

<https://www.truma.com/uk/en/home>



Thetford Ltd.
Unit 6, Brookfields Way, Manvers,
Dearne Valley, Rotherham,
South Yorkshire, S63 5DL
Phone - 0844 997 1960
Fax - 0844 997 1961
Email - infogb@thetford.eu

<https://www.thetford-europe.com>



Dometic (UK) Ltd
Dometic House, The Brewery,
Blandford St Mary, Dorset, DT11
9LS
Phone: 0844 626 0133
Email: technical@dometic.co.uk

<https://www.dometic.com/en-gb/uk>



2 Enterprise Road, Bangor, Co.
Down, Northern Ireland, BT19 7TA
Phone: 0845 217 2933
Email: info@whalepumps.com

<https://www.whalevanlife.com/>



1.4 Annual service / inspection record

In order to comply with the warranty, you must have your motorhome inspected and serviced in accordance with the warranty.

We highly recommend that you have your Motorhome serviced by a Swift Group Approved Service Centre who have direct access to our online Customer Service system, My Swift Life. This system provides them with the ability to order approved parts and ensure that any product upgrades which may be available for your Motorhome can be offered to you and carried out as part of the service. In the unfortunate event that an issue requires attention under warranty then a Swift Group Approved Service Centre are able to submit a warranty claim to the Swift Group for processing, and deal with the issue for you from start to finish. All of our Swift Group Approved Service Centres are provided with up to date technical information and have access to current repair methods giving you peace of mind that any defect has been repaired effectively.

It is important that the owner's handbook is stamped on the appropriate page by the authorised Swift Group Service Centre.

Failure to do this will invalidate the warranty and the transfer of the warranty on the change of ownership.

The inspection should take approximately two hours and will cover the areas dealt with in the annual service check list. Any areas requiring service and/or maintenance will be highlighted by your dealer and we recommend that you authorise any necessary work to be carried out.

Just as the engine/gearbox/roadwheels need regular servicing by your chassis dealer, so there are components in your conversion that need regular maintenance by your motorhome dealer.

These include the gas and electrical systems and the seals in the bodywork. Your dealer will complete the record in this handbook to show that the work has been carried out.

1. Damp and lamination test.
2. Chassis and chassis to body security.
3. Motorhome step.
4. Road lights, wiring and reflectors.
5. Internal lights and 12V DC system.
6. Water heater - gas and 230V AC.
7. Hob, grill and oven.
8. Refrigerator 230V AC and 12DC.
9. Gas system.
10. Water pump, taps and water system.
11. Mains 230V AC system.
12. Windows and fittings.
13. Roof lights.
14. Furniture hinges/stays etc.
15. Exterior locks and hinges.
16. All internal vents.
17. Seals.
18. Blinds and fly screens.
19. Blown air heating systems.
20. Smoke alarm and battery
21. Carbon monoxide detector and battery
22. Elevating Roof

Annual service/inspection record

<p>Motorhome model:</p> <p>Registration number</p> <p>Chassis number</p> <p>Registration date</p>	<p>1st service</p> <p>Date:</p> <p>Dealer's Stamp</p> <p>We certify that an annual service has been carried out in accordance with the handbook.</p>
<p>2nd service</p> <p>Date:</p> <p>Dealer's Stamp</p> <p>We certify that an annual service has been carried out in accordance with the handbook.</p>	<p>3rd service</p> <p>Date:</p> <p>Dealer's Stamp</p> <p>We certify that an annual service has been carried out in accordance with the handbook.</p>
<p>4th service</p> <p>Date:</p> <p>Dealer's Stamp</p> <p>We certify that an annual service has been carried out in accordance with the handbook.</p>	<p>5th service</p> <p>Date:</p> <p>Dealer's Stamp</p> <p>We certify that an annual service has been carried out in accordance with the handbook.</p>
<p>6th service</p> <p>Date:</p> <p>Dealer's Stamp</p> <p>We certify that an annual service has been carried out in accordance with the handbook.</p>	<p>7th service</p> <p>Date:</p> <p>Dealer's Stamp</p> <p>We certify that an annual service has been carried out in accordance with the handbook.</p>

<p>8th service Date: Dealer's Stamp</p> <p>We certify that an annual service has been carried out in accordance with the handbook.</p>	<p>9th service Date: Dealer's Stamp</p> <p>We certify that an annual service has been carried out in accordance with the handbook.</p>
<p>10th service Date: Dealer's Stamp</p> <p>We certify that an annual service has been carried out in accordance with the handbook.</p>	<p>11th service Date: Dealer's Stamp</p> <p>We certify that an annual service has been carried out in accordance with the handbook.</p>
<p>12th service Date: Dealer's Stamp</p> <p>We certify that an annual service has been carried out in accordance with the handbook.</p>	<p>13th service Date: Dealer's Stamp</p> <p>We certify that an annual service has been carried out in accordance with the handbook.</p>

2. Motorhome code

2.1 Camp sites	14
2.2 Wild camping	15
2.3 Handbooks (Chassis & Converter)	15
2.4 The Country code	16
2.5 The coastal code	16

2.1 Camp sites

Arrivals

Report to reception immediately on arrival.

Vehicle Movement

Keep to roadways unless otherwise directed. Adhere to speed limits. Note that these are generally 10 mph. (Remember that the stopping distance on grass is considerably greater than on tarmac.)

Only a person in possession of a current driving licence may drive on the site.

Park correctly as advised on your pitch. Where possible leave 20 feet of free space around your vehicle.

Use of Site Appliances

Use the electrical mains hook-up in the correct manner and with caution. Ensure that all fresh water taps/connections are turned off after use. Have care and consideration when using all facilities (toilets and showers etc) and leave clean and tidy. Young children should be supervised.

Waste Disposal

If the vehicle is not fitted with a waste water tank, a suitable receptacle should be placed below all waste water outlet pipes. Do not let these containers overflow. Dispose of all waste water where instructed. Empty effluent from chemical toilets where instructed.

To avoid possible damage to sewage purification works, only approved chemical fluids must be used. Under no circumstances should coal tar, phenol or caustic-based fluids be used.

Disposable nappies and similar bulky items must not be put into chemical closet emptying points but should be wrapped in a polythene bag and placed in the container provided.

Place all litter in containers marked for the purpose.

Noise

Do not make excessive noise. Children should be restrained from making excessive noise.

Flying kites, drones and model aircraft, and the use of items like catapults or air-guns, as well as ball games, should not be permitted among, or close to other vehicles.

Musical instruments, record players, radios and televisions should not be used to the inconvenience of other people on the site.

Open and close doors quietly. Power generators must be adequately silenced and used with consideration.

Dogs and other Pets

All dogs and other pets should be kept under control. Unless permission has been granted, no animal should be allowed loose on the site and leads must not exceed 10ft.

No animals should be allowed in the shower/toilet blocks.

Do not let dogs foul the site.

Fire Precautions

Adhere to and take note of fire precautions noting the whereabouts of the fire points.

 **WARNING:** Provide one dry powder fire extinguisher of an approved type or complying with EN3-7 or ISO 7165, of at least 1kg capacity, by the main exterior door and a fire blanket next to the cooker. Familiarise yourself with the operating instructions on your fire extinguisher and the local fire precaution arrangements.

When using a dry powder extinguisher it is suggested that the motorhome be evacuated until the powder has settled, to avoid inhalation.

Code of conduct

Unless permission has been granted, barbecues should not be used. If permission is given, consideration should be given to the annoyance that can be caused to other users of the site.

Open fires are not allowed.

Awnings and Tents

Awnings and tents should only be used when permission has been obtained. When on grass and staying for more than a few days, the ground sheet and/or side flaps of awnings should be periodically raised in order to avoid damage to the ground.

Departure

Leave the pitch clean and tidy.

On leaving, check out with reception paying the required fees.

2.2 Wild camping

Camping away from licensed sites, without the permission from the land owner or his agents, is not allowed in the United Kingdom.

When permission has been granted, all aspects of this Code should be adhered to.

On no account should:

- a. Litter be disposed of other than in the receptacles provided.
- b. Water be allowed to escape from the vehicle.
- c. Chemical toilets be emptied except into the disposal places agreed with the land owner.
- d. Washing or similar be hung outside the vehicle.

Parking

Motorhomes should only be parked in approved places.

When using the facilities of a motorhome, care and consideration should be given to those around them.

Driving

Before moving off, elevated rooflights and aerials should be lowered and correctly secured, and top hinged windows closed. Likewise all doors and access lockers for gas containers and chemical toilets must be properly secured.

Exterior steps should be properly retracted and secured. When the vehicle is in motion it is compulsory for all front seat passengers and rear seat passengers to wear seat belts, where fitted. When using a motorhome on either the public highway or private roads the Highway Code should be complied with and full consideration given to other road users.

In the event of a motorhome travelling slowly the driver of the motorhome should, where possible, pull over in order to let other traffic pass.

⚠ WARNING: When travelling, refuelling or on a ferry ensure the gas system is fully isolated at source.

2.3 Handbooks (Chassis & Converter)

Before using a motorhome all aspects of the handbooks, produced by the chassis manufacturer and the converter, must be read and adhered to.

The separate chassis manufacturer handbook refers to your motorhome chassis and base vehicle including care and maintenance.

Ford handbook



<https://bit.ly/3JpAkrN>

Ford Pass

Unlock Fords smart side for added peace of mind, FordPass provides the ability to remote lock and unlock your vehicle, check its last location, view the health status and more.

<https://www.ford.co.uk/technology/connectivity/fordpass>



Environment

Care and consideration should be taken to protect the environment. Observe the Country and Coastal Codes.

2.4 The Country code

Enjoy the countryside but respect its life and work.

More people than ever before are exploring the countryside, interested in farming, plant life, bird watching or just observing the general wildlife. Whatever your interest, there is a lot to learn, but please observe the following code:

1. Guard against all risk of fires. Hay and heathland catch alight easily and once ablaze are very difficult to put out.
- Remember: fire spreads quickly.**
2. Fasten all gates.
 3. Keep your dog under proper control.
 4. Keep to the paths across farm land.
 5. Avoid damaging fences, hedges and walls.
 6. Leave no litter.
 7. Safeguard water supplies.
 8. Protect wildlife, wild plants and trees.
 9. Go carefully on country roads.
 10. Respect the life of the countryside. The Coastal code

2.5 The coastal code

As our coastlines are increasingly used for recreation and education, the following suggestions are made to enable us to enjoy our inheritance and preserve it for posterity.

Do not trample about, or move rocks unnecessarily.

Do not frighten seals or seabirds.

Do not spill detergents, solvents or fuel from boats as these can kill marine life.

When sailing, moderate your speed - the wash from a fast boat can destroy banks and nests.

Live molluscs and crustaceans need not be collected as souvenirs - dead shells can usually be found.

Shellfish can take years to grow and fines can be imposed for not observing national regulations.

Do not pull up seaweeds unnecessarily. Make your visit instructive - not destructive.

Look at material - don't remove it. Take notes and photographs, not specimens.

Observe by-laws and be considerate to others.

National Trust property and Country Parks have regulations to protect the wildlife. Follow these and the Country and Coastal Codes.

3. Preparing for the road

3.1 Before moving off	18
3.2 Motorhome terms	18
3.3 Loading of vehicle	19
3.4 Large storage areas	20
3.5 Tyres	20
3.6 Dedicated travelling passenger seating	20
3.7 Child seats	21
3.8 Airbag	22
3.9 ISOFix Child Seat Restraint	22
3.10 Three point seat belts	23
3.12 Advice on towing	24
3.13 European Touring	25

3.1 Before moving off

Check:

- Gas cylinders are correctly positioned, secured and turned off.
- All gas operated appliances have been isolated.
- Loose articles are stowed securely. Do not stow tins, bottles or heavy items in overhead lockers.
- All lockers and cupboard doors are closed and secured.
- Tables are stored or locked in their transit position.
- Fridge is on 12V or auto operation and door lock is set.
- 230V mains input socket and BBQ point flaps are securely closed.
- All drain valves are closed.
- Tyre pressures are within the recommended limits.
- Exterior roof rack ladder / bike rack is secured (where fitted).
- All windows/doors/rooflights are closed and secured.
- Exterior step (where fitted) is retracted / folded in.
- Special attention must be taken to ensure all top hinged windows as well as rooflights are closed when in transit. All units should be fully closed and latched to prevent damage. The motorhome rear and side sliding door should also be locked.

⚠ WARNING: Large and/or voluminous items should be stored securely before travelling.

- Road worthiness of your vehicle (oil level, tyre pressure, road lighting)
- The elevating roof is fully down with catches and retainers secure.
- The panel van rear and side sliding doors are locked.

3.2 Motorhome terms

Mass in Running Order:

The mass of the motorhome equipped to the motorhome manufacturers standard specification, as stated by the manufacturer.

The MRO comprises the ex-works weight of the motorhome, including the driver, 90% fuel capacity, an 11kg allowance for LPG and standard fixtures & fittings in compliance with European Regulation No. 1230/2012 (Masses & Dimensions)

Note: The mass of the motorhome in running order contains provision for the masses of liquids, gas etc. (see Mass in Running Order in the Technical Section). Part of this provision can also be utilised as additional payload, if for example, you wish to travel with no gas cylinders.

Note: If you travel with water in the fresh water tank or waste tank, the payload will be reduced accordingly.

Note: Quoted MRO is subject to tolerance, due to weight variation of materials used in Motorhome construction.

Maximum User Payload:

The maximum allowable weight to be put into the motorhome whilst it is being driven. This is made up of 4 sections:

Personal effects, conventional load, optional equipment and essential habitation equipment.

The Maximum User Payload is the difference between the Maximum Technically Permissible Laden Mass and the Mass in Running Order.

Personal Effects:

Those items which a user can choose to carry in a motorhome and which are not included as Essential Habitation Equipment or Optional equipment.

Conventional Load:

A mass allowance of 75kg for each designated passenger seat.

Optional Equipment:

Items made available by the manufacturer over and above the standard specification of the motorhome.

Essential Habitation:

A mass allowance for liquids in systems not accounted for within the MRO.

Maximum Technically Permissible Laden Mass:

The maximum weight for which the motorhome is designed for normal use when being driven on a road, laden.

This mass takes into account specific operating conditions including factors such as the strength of materials, loading capacity of tyres etc.

Gross Train Weight:

The maximum combined weight of the motorhome and trailer.

⚠ WARNING: Under no circumstances should the axle loadings or the Maximum Technically Permissible Laden Mass of the motorhome be exceeded.

Nose weight on towed trailers:

The static mass of the trailer towing device on the rear of the towing vehicle.

When measuring the nose weight it is important that the trailer is loaded.

The trailer is intended to be towed slightly nose heavy. The nose weight can be adjusted by distribution of the load. The nose weight should be approximately 7% of the actual laden weight (but not greater than the hitch capacity) and at the same time suit the motorhome requirements. See 'Advice on Towing' page 28.

3.3 Loading of vehicle

⚠ WARNING: Loads must not be exceeded. The driver is responsible for arranging the loads so that they comply with the technical weight limits of the specific motorhome model.

See Technical handbook.

Correct weight distribution is an important factor in ensuring your vehicle is well balanced and easy to drive. It is therefore necessary to load your motorhome carefully making sure all heavy articles are evenly distributed and are preferably placed in the lower lockers or bed boxes.

⚠ WARNING: Do not travel with televisions or microwaves in overhead lockers unless the appliance was supplied fitted to your motorhome by the manufacturer.

Although it is essential to ensure that the total weight of your motorhome does not exceed the stipulated Maximum Technically Permissible Laden Mass, (MTPLM), it is important to remember that the front and rear axles also have individual maximum weights which must not be exceeded.

To ensure adequate road holding the load on the front axle, under all conditions, must not be less than 40% or more than 70% of the total weight.

Ensure you distribute the payload equally on each side of the vehicle to avoid an imbalance.

These weights, together with the MTPLM, can be found on the statutory plate affixed to the passenger door B pillar.

⚠ WARNING: Turn off all gas appliances while the vehicle is in motion.

⚠ WARNING: Please take care to ensure you have allowed for the masses of all the items you intend to carry in your motorhome e.g. passengers, optional equipment, essential habitation equipment and personal effects such as clothing, food, pets, bicycles, sailboards and sports equipment etc.

Note: Care must be taken to ensure that exterior doors are closed, locked and that all possessions are properly stored and secured before setting off on any journey.

3.4 Large storage areas

The large storage areas provided in some motorhome layouts are designed solely for the purpose of carrying personal possessions, these areas must not be used:

- As a habitation area (eg living, sleeping or cooking).
- To carry passengers, animals or livestock.
- For the installation (or use) of any LPG gas operated appliances (unless supplied fitted by the manufacturer).
- For carrying LPG gas cylinders.
- To carry any flammable liquids, unless properly stored, sealed and secured.
- For the operation of an electrical generator.
- In such a way that the load exceeds the MTPLM, and/or minimum and maximum axle loads.

Care must be taken to ensure that exterior doors are closed, locked and that all possessions are properly stored and secured before setting off on any journey.

3.5 Tyres

If a wheel or tyre is changed any replacement must be of the same type of construction and size.

The law requires that the tyres and pressures must be suitable for the use to which they are being put. The minimum tread depth must be 1.6mm throughout a continuous band comprising the centre three-quarters of the breadth of the tread and around the circumference of the tyre.

Please refer to the base vehicle manufacturer's handbook for tyre pressure information. This may also be displayed in the driver's or passenger's door aperture.

The motorhome tyre pressure noted in the base vehicle handbook are the pressures stated by Ford for your vehicle calculated in a fully laden condition. If you are not running fully laden, reduced pressures could be used but please seek clarification from the tyre manufacturer.

3.6 Dedicated travelling passenger seating

Seat belts are fitted to all travelling seats. Travelling seats are designated by the manufacturer and vary according to the layout you have purchased. Each seat is homologated i.e. tested to all relevant safety requirements. NEVER travel in or attempt to install a seatbelt to a non-designated seat.

⚠ WARNING: Side facing seats are designed for habitation use only, not for when the vehicle is in motion.

Seat belts and legislation

Designated driver and passenger seats are fitted with seat belts and **MUST** be worn when travelling.

Children, aged up to 3 years of age, must wear an appropriate child restraint suitable for their age and weight. Children from 3 years of age and up to 135cm (4'5") in height, or 12 years of age, whichever is reached first must use a child car seat or booster seat suitable for their age.

Children over 135cm (4'5") in height or aged 12 years and over must wear a seat belt.

Note: It is the legal responsibility of the driver to ensure children aged up to 14 years old are suitably restrained. For passengers aged 14 and over, it is their responsibility (not the driver) that a seat belt is worn.

Seat belts are fitted for your safety and must be worn unless a 'Certificate of Exemption from Compulsory Seat Belt Wearing' is held. This Certificate must be produced if asked for by the Police - seat belt offences can result in a fine.

WARNING: Passengers should only be carried in designated passenger seats fitted with approved 3-point seat belts. Children should be seated in correctly fitted child seats when the vehicle is in motion.

3.7 Child seats

Choosing/Buying

Go to a reputable retailer such as Halford's, Smyths, John Lewis etc. Most reputable retailers will have trained child seat advisers on site and will offer a fitting service. Ask the advisor to fit various seats to the vehicle. Once a correctly fitted seat has been installed, satisfy yourself on it's suitability for your child and the vehicle before buying as it is important to use a correctly fitting seat in your motorhome.

WARNING: The child seat you use in your car may not be suitable for mounting on a motorhome seat.

WARNING: Choose the right seat for your child's height and weight.

Height-based seats

Height-based seats are known as 'i-Size' seats. They must be rear-facing until your child is over 15 months old. Your child can use a forward-facing child car seat when they're over 15 months old.

You must check the seat to make sure it's suitable for the height of your child.

Only EU-approved height-based child car seats can be used in the UK. These have a label showing a capital 'E' in a circle and 'R129'.

Weight-based seats

The seat your child can use (and the way they must be restrained in it) depends on their weight.

Only EU-approved weight-based child car seats can be used in the UK. These have a label showing a capital 'E' in a circle and 'ECE R44'.

You may be able to choose from more than one type of seat in the group for your child's weight.

For more information visit www.gov.uk

Never fit or use a second hand car seat. It could have been damaged and may not meet modern standards. The fitting instructions may also be missing.

Positioning/Fitting

Dependant upon the child seat type, the most suitable position for the child seat to be fitted may be the front passenger seat of the cab (NOTE airbag advice on following page) or the forward facing rear seat.

If using a seat with ISOfix, the position would be on the aisle seat with the ISOfix brackets on the seat frame. The top tether on the frame is behind the removable section of the head pad.

If using a seat without ISOfix, the window seat is recommended. The aisle seat is NOT a recommended position for this type of seat.

Advice should always be taken from the retailer on the suitability and security of the seat in the motorhome. Read and follow the child seat manufacturer's instructions for fitting the seat.

All Swift motorhomes are fitted with inertia reel seat belts, however, the child seat must be tight in the adult seat. Push all your weight into the child seat as you tighten the belt.

Keep a copy of the child seat fitting instruction in the motorhome for easy reference.

Any doubts, ask an advisor to show you how to correctly install the seat.

3.8 Airbag

Never fit a rear facing child restraint in a seat with an active airbag in front of it.

Forward-facing child restraints should be positioned as far back from the airbag as possible. Check the base vehicle handbook.

⚠️WARNING: Extreme Hazard! Never use a rear ward facing child restraint on a seat protected by an active airbag in front of it. Death or serious injury to the child can occur.

⚠️WARNING: You must switch the passenger airbag off when using a rearward facing child restraint on the front seat.

⚠️WARNING: You must switch the passenger airbag on following the removal of the child restraint.

⚠️WARNING: Do not modify child restraints in any way.

⚠️WARNING: Do not hold a child on your lap when your vehicle is moving.

⚠️WARNING: Do not leave children or pets unattended in your vehicle. Failure to follow this instruction could result in personal injury or death.

⚠️WARNING: If your vehicle has been involved in a crash, have the child restraints checked.

⚠️WARNING: Do not put the shoulder section of the seatbelt or allow the child to put the shoulder section of the seatbelt under their arm or behind their back. Failure to follow this instruction could reduce the effectiveness of the seatbelt and increase the risk of injury or death in a crash.

⚠️WARNING: Do not use pillows, books or towels to boost your child's height. Failure to follow this instruction could result in personal injury or death.

⚠️WARNING: Always make sure your child is secured properly in a device that is appropriate for their height, age and weight. Child safety restraints must be bought separately from your vehicle. Failure to follow these instructions and guidelines may result in an increased risk of serious injury or death to your child.

3.9 ISOFix Child Seat Restraint

⚠️WARNING: Use a top tether anti-rotation device when using the ISOFIX system.

Do not use a child restraint with a support leg. Top tethers must be used.

⚠️WARNING: Only child restraints certified to ECE-R129 or ECE-R44.03 (or later) have been tested and approved for use in your motor home.

The rear aisle seat is fitted with ISOFix anchor points that accommodate universally approved ISOFix child seats. Top tether anchorage points are also provided. The seats are not suitable for child restraints that require a support leg as the seats are too high above the floor. Only use child restraints provided with top tethers.

The ISOFIX system comprises two rigid attachment arms on the child seat that attach to anchor points on the rear seat frame, located where the cushion and backrest meet. Positions are marked on the cushions.



Top tether anchor points are fitted on the upper seatbelt stanchion and are accessed by removing an insert on the backrest cushion.



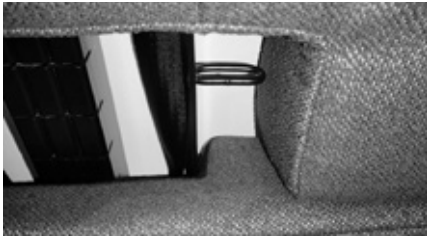

General Seat Installation Method:

1. Place the child seat on the seat cushion.
2. Remove the top tether insert.
3. Route the tether strap to the anchor point and secure.
4. Push the child seat back firmly to engage the ISOFIX lower anchor points.
5. Tighten the tether strap in line with the child seat manufacturer's instructions.

⚠️WARNING: Please consult with the child seat manufacturer's instructions for full installation instructions. If in doubt please consult the child seat manufacturers technical support team for further guidance on the installation.

⚠️WARNING: Do not attach the top tether strap to anything other than the correct top tether strap anchor point.

⚠️WARNING: Make sure that the top tether strap is not slack or twisted and is properly located on the anchor point.

⚠️WARNING: Make sure the child restraint rests tightly against the vehicle seat.

ISOFIX CHILD RESTRAINT POSITION INFORMATION

Seating Position		Lateral Facing	Rearward Facing	Rearward Facing	Forward Facing	Rearward Facing
		0 - 10 kg	0 - 10 kg	0 - 13 kg	9 - 18 kg	9 - 18 kg
Front Passenger	Size class ¹	No ISOFIX				
	Fixture ¹					
2nd row aisle seat	Size class	X	E	C, D, E	A, B, B1	C, D
	Fixture	X	R1	R1, R2, R3*	F2, F2X, F3	R2, R3*

¹The size class and fixture are defined for both universal and semi-universal child restraint systems. You can see the identification letters on ISOFIX child restraints.

X Seat is not suitable for use with this size class of child restraint system.

R3* - Trekker X only

3.10 Three point seat belts

This section refers to the seat belts located in the habitation area of your motorhome.

Fastening the seat belt:

Insert tongue into buckle; a positive 'click' indicates correct assembly.

Releasing the seat belt:

Press the red release button, the tongue will be ejected from the buckle.

- The belt is designed for use by one person and must not be put around a child seated on a person's lap.

- The belt on the outer seat is suitable for restraining most child seats and boosters. The rear aisle seat is the only seat position suitable for ISOFix child seats
- The belt should at all times be adjusted and used in accordance with the instructions. No excessive slackness should be present.
- Once installed the diagonal should pass across the centre of the shoulder and the buckle should lie just on or below the hip.
- Avoid twisting the webbing during use. Webbing must not be allowed to chafe against sharp edges.

- Do not make alterations or additions to the belt.
- Belts that have been cut, frayed, damaged or stressed through impact should be replaced. After impact the motorhome anchorage points should also be checked.
- To clean use warm soapy water only.
- Periodic inspection of the installation will ensure reliability of the seat belt.

3.11 Driving licence

Drivers who passed their car driving test (category B) before 1 January 1997 are usually allowed to drive a vehicle and trailer combination up to 8,250kg maximum authorised mass (MAM). You're also allowed to drive a minibus with a trailer over 750kg MAM.

The MAM is the weight of the vehicle or trailer which is listed in the owner's manual and is normally shown on a plate or sticker fitted to the vehicle or trailer.

Drivers who passed their test after 1997 can drive vehicles up to 3,500kg maximum authorised mass (MAM) with up to 8 passenger seats. Drivers can also tow a trailer that weighs up to 3,500kg MAM.

You must check you have the correct driving licence entitlement for the vehicle you drive.

3.12 Advice on towing

The towing capability of each motorhome differs depending on the specific chassis and engine types, (see 'Towing Capabilities Table' in your specification section).

This table takes account of the maximum front and rear axle loadings as well as the minimum front axle loading in two conditions, MRO and MTPLM condition.

Towing in these, and any other condition requires sensible loading and distribution of payloads to ensure the requirements of the towing capability table are met.

When towing, the demands on both the vehicle and driver increase. A trailer reduces manoeuvrability, the ability to climb hills, acceleration and braking capacity and makes the vehicle handle and corner differently. It will also increase the fuel consumption of the vehicle.

Always brake in good time. Special care must be taken when descending gradients. Change down before going down a steep hill so the

engine can act as a brake. Ensure that the towing vehicle tyre pressures are correct and adjusted for full load conditions and that the trailer tyre pressures are as recommended by the trailer manufacturer. Regularly check the operation of trailer brakes and lights.

For maximum stability, when loading the trailer ensure that the loads are properly secured during transit. Position loads so that most of the weight is placed close to the floor and, where possible, immediately above or close to the axle(s). Where the load can be divided between trailer and tow vehicle, loading more weight into the vehicle will generally improve the stability of the combination.

After loading the trailer, check that the nose weight and axle loads are in accordance with the manufacturer's recommendations, also check the rear and front axle loads on the motorhome. When calculating the laden weight of the trailer, remember to include the weight of the trailer PLUS THE LOAD.

Note: Towing regulations vary from country to country. It is very important to ensure that national regulations governing towing weights and speed limits are observed (refer to the relevant national motoring organisation for information). The stated maximum permissible towing weights refer to the vehicle's design limitations and NOT to any specific territorial restrictions.

Notes:

6. Do not exceed the motorhome gross vehicle train weight.
7. Do not exceed the maximum front & rear axle loads on the motorhome.
8. Ensure the motorhome front axle load is never less than 40% or more than 70% of the total weight.
9. Motorhomes with an MTPLM up to 3500kg which have European Type approval can only be fitted with a type approved towbar complying to 94/20/EC or UN ECE R55.
10. The limit for towing an un-braked trailer is 750kg (based on VIN plate not actual weight), this applies to a towed car.
11. A car dolly with a car with a GVW over 750kg in place is considered as two trailers, these are legal for use for recovery but under the Road Traffic Regulations Act 1984 the combination is limited to 40 mph

on motorways and dual carriageways and 20 mph elsewhere. A car dolly is not legal for transportation (there is a very specific difference between recovery and transportation. Recovery is defined as the removal of a broken down vehicle to a place of safety).

12. The maximum permitted vehicle combination length is 18.75m, however any combination must ensure compliance with the turning circle requirements of Construction and Use regulations 1986 & EU 1230/2012.

Note: Not all motorhomes are suitable for towing and may not have sufficient payload to permit towing. If in doubt, consult your dealer.

3.13 European Touring

Please note there are a number of requirements placed on a driver when driving on European roads. Carrying a warning triangle, high visibility jacket, first aid kit and spare bulb is now compulsory in many EU states but some EU countries are now introducing further regulations such as carrying a breathalyser kit and not being able to use satellite navigation systems with speed camera warnings.

We would advise customers to check on the many web-sites available to ensure you are carrying the correct equipment when touring in those EU countries

4. En-route

4.1 Tyre Sealant and Inflator Kit (FORD) (where fitted)	28
4.2 Cruise control	29
4.3 Parking sensors	29

4.1 Tyre Sealant and Inflator Kit (FORD) (where fitted)

What is the tyre sealant and inflator kit

The kit consists of an air compressor to re-inflate the tyre and a canister of sealing compound that effectively seals most punctures. This kit provides a temporary tyre repair allowing you to drive your vehicle up to 200km (120 mi) at a maximum speed of 80 km/h (50 mph) to reach a tyre service location.

Tyre sealant and inflator kit precautions

⚠ WARNING: Depending on the type and extent of tyre damage, some tyres can only be partially sealed or not sealed at all. Loss of tyre pressure can affect vehicle handling, leading to loss of vehicle control.

⚠ WARNING: Do not use the kit on a previously damaged tyre. For example, when it has been driven under-inflated. This when it could have caused loss of vehicle control, personal injury or even death.

Do not attempt to repair punctures larger than 6mm (0.24 in) or damage to the tyre's sidewall.

Only punctures located within the tyre tread can be sealed with the kit.

Only use the kit supplied with your vehicle.

The temporary mobility kit contains enough sealant compound in the canister for one tyre repair only.

After using the sealant, an authorised dealer needs to replace the tyre pressure monitoring system sensor and valve stem on the wheel.

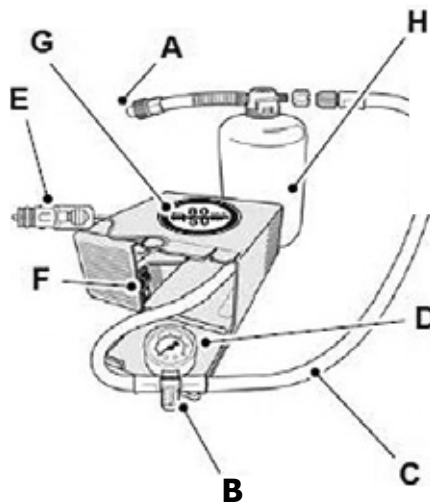

E146784

- A) Protective cap
- B) Pressure relief valve
- C) Hose
- D) Pressure gauge
- E) Power plug with cable
- F) Compressor switch
- G) Label
- H) Sealant bottle

ⓘ Note: Make sure you regularly check the expiry date on the sealant bottle.

Using the tyre sealant and inflator kit

⚠ WARNING: The sealant contains natural rubber latex. Avoid contact with skin and clothing. If this happens, rinse the affected areas immediately with plenty of water and consult a physician.

⚠ WARNING: Do not leave the kit unattended when it is in use. Failure to follow this instruction could result in personal injury or death.

⚠ WARNING: Check the sidewall of the tyre prior to inflation. If there are any cracks, bumps or similar damage, do not attempt to inflate the tyre. This could cause personal injury.

1. Check for a punctured tyre.

Note: Do not remove objects. For example, nails or screws from a punctured tyre.

2. Open the lid of the tyre sealant and inflater kit.
3. Peel off the label G showing the maximum permissible speed of 50 mph (80 km/h) from the casing and attach it to the instrument panel in the driver's field of view. Make sure the label does not obscure anything important.
4. Take the hose C and the power plug with cable E out of the temporary mobility kit.
5. Screw the hose C onto the sealant bottle.
6. Remove the valve cap from the damaged tyre.
7. Remove the protective cap A from the sealant bottle hose and screw the hose firmly onto the valve of the damaged tyre.
8. Make sure that the compressor switch F is in position 0.
9. Insert the power plug E into the auxiliary power point.
10. Start the engine.

WARNING: Do not stand directly beside the tyre while the compressor is operating. This could cause personal injury if the tyre bursts.

11. Move the compressor switch F to position 1.
12. After a minimum of two minutes, move the compressor switch F to position 0 and unscrew the hose C from the sealant bottle. Unscrew the sealant bottle hose from the tyre valve.
13. Screw the hose C onto the tyre valve and move the compressor switch F to position 1.

WARNING: Watch the sidewall of the tyre when inflating. If any cracks, bumps or similar damage appears, switch the compressor off and let the air out by means of the pressure relief valve. Do not continue driving with this tyre. This could cause loss of vehicle control.

WARNING: Do not keep the compressor operating for more than 10 minutes. This could cause the compressor to malfunction causing serious personal injury.

4.2 Cruise control

The driver of the vehicle should always remain seated and in control of the vehicle when cruise control has been engaged. Never leave the driving seat for any reason when the vehicle is underway

4.3 Parking sensors

Parking sensors are fitted to some vehicles. Please use the information provided. Use the sensors as a guide only. It is the responsibility of the driver to ensure it is safe to reverse the vehicle.

5. Safety and security

5.1 Fire	32
5.2 Smoke Alarm Operation	32
5.3 Fire Extinguisher	32
5.4 Escape paths	32
5.5 Children	32
5.6 Ventilation	33
5.7 CO alarm	33
5.8 Security	34
5.9 VIN CHIP™	34

5.1 Fire

Note: Your attention is drawn to the notice affixed inside the lower rear nearside cupboard in the rear bed area advising on fire precaution, ventilation and what to do in case of fire.

In case of fire

1. Get everyone out of the motorhome as quickly as possible using whichever exit is the quickest, including windows. Do not stop to collect any personal items.
2. Raise the Alarm. Call the Fire Brigade.
3. Turn off the gas supply valve if it is safe to do so.
4. Turn off the electricity supply at supply point.

5.2 Smoke Alarm Operation



Your motorhome is fitted with a Fire Angel SB1 smoke alarm. Please read the user instructions for the smoke alarm, which are available at the following location:

<https://www.fireangel.co.uk/products/sb1-t>



If you are unable to view the documents on line, please contact the supplier, your dealer or Swift for an electronic or paper copy.

⚠ WARNING: Never use portable cooking or heating equipment other than electric heaters that are not of the direct radiant type, as it is a fire and asphyxiation hazard.

⚠ WARNING: Appliances such as cookers must not be used for heating.

5.3 Fire Extinguisher

It is recommended that a dry powder fire extinguisher be carried inside your motorhome at all times.

When using a dry powder extinguisher it is suggested that the motorhome be evacuated until the powder has settled, to avoid inhalation.

A fat pan fire should not have a fire extinguisher aimed at it. It should be smothered with a fire blanket.

⚠ WARNING: Provide one dry powder fire extinguisher of an approved type or complying with EN3-7 or ISO 7165, of at least 1kg capacity, by the main exterior door and a fire blanket next to the cooker. Familiarise yourself with the instructions on your fire extinguisher and the local fire precaution arrangements.

5.4 Escape paths

In the event of an emergency, both the main entrance sliding door and rear door(s) are emergency exits on all layouts.

It is important that you do not block escape paths to emergency exits with obstructions or hazards.

As your motorhome is fitted with a childproof locking system please ensure it is not activated when parked off the public highway. For more information please see the base vehicle handbook.

5.5 Children

Do not leave children alone in the motorhome in any event. Keep potentially dangerous items out of reach, as at home e.g. matches, medicine etc.

5.6 Ventilation

All motorhomes comply with BS EN 721. The ventilation points on your motorhome are fixed points of ventilation which are required by the European Standards.

All motorhomes have ventilation at high level and low level which have been calculated to suit the individual needs of your motorhome.

High level ventilation is achieved by means of the roof lights and washroom roof ventilators (where applicable). The low level ventilators are positioned under furniture units.

Under no circumstances must these vents be blocked or obstructed in any manner as this could lead to insufficient fresh air. In this case the confined atmosphere becomes depleted of oxygen which could lead to dangerous levels of carbon dioxide (CO₂) build up leading to the risk of asphyxiation.

The risks of carbon monoxide (CO) build up, which is a colourless, odourless and tasteless gas, will also be reduced with ventilation. Carbon monoxide is produced from incomplete combustion and should the CO detector be activated the cause of the incomplete combustion must be investigated prior to reusing the appliance in question.

It is advised that fixed ventilation points are checked and cleaned (if necessary) on a regular basis using a small brush and a domestic vacuum cleaner.

Additional night time ventilation is obtained by releasing the window catches and placing them in the second groove. Note the windows are not sealed from rain in this position.

As the ventilation levels are calculated to suit each model requirements no modifications should be made which may result in reduced ventilation levels.

⚠ WARNING: Do not obstruct ventilation.

⚠ WARNING: When you are cooking it is essential to provide additional ventilation, such as opening windows near the grill, cooler and oven. Do not use cooking appliances for space heating.

It is recommended that the elevating roof be raised when the leisure accommodation vehicle is used for habitation purposes.

5.7 CO alarm



Your motorhome is fitted with a FireAngel FA3820 Carbon Monoxide Alarm. To activate the alarm, you will need to pull the disabling tab. For further information, please read the instructions for the alarm, which are available at the following location:

bit.ly/3VZ5XOj



If you are unable to view the documents on line, please contact the supplier, your dealer or Swift for an electronic or paper copy.

5.8 Security

Motorhome theft:

The theft of a motorhome can occur in the most unlikely circumstances; from a motorway service area or even an owner's driveway. Secure all windows and doors when your motorhome is unoccupied even if only for a short length of time.

VIN (Vehicle identification Number)

Record your motorhome VIN which can be found on the lower edge of the base vehicle front windscreen and the plate located on the passenger door B pillar.

Make a note of these numbers in the space provided at the front of this handbook and make a separate note of the numbers to keep safe at home.

Additional security

Consider fitting any device which might deter intrusion by thieves. Customers are advised to identify their motorhome with a method for subsequent identification if other forms of identification have been altered or removed.

Free crime prevention advice about securing your motorhome, protecting your valuables, property marking either at home or whilst on site, can be obtained from the Crime Prevention Officer through your local Police station.

5.9 VIN CHIP™

Your motorhome has been securely marked and the VIN recorded with VIN CHIP™.

VIN CHIP™ is the industry standard security marking system for touring caravans and motorhomes.

Shortly after purchasing this motorhome, you will receive via email your VIN CHIP™ registration document. This document will include the 17 digit VIN (vehicle identification number) and other relevant details about your motorhome. If you sell your motorhome, please follow the instructions on the VIN CHIP motorhome document.

VIN CHIP identification

The motorhome's unique 17 character VIN will be incorporated into VIN CHIP tamper evident labels;

The master VIN CHIP label is situated on the front near side window to aid police checking, another in the gas locker and a maximum of 10 placed on the inside of the windows (with the exception of opaque windows).

Three electronic RFID chips containing the individual identity of your caravan are concealed within the motorhome and can only be read by using a specially programmed RFID scanner.

Your local police can obtain the use of a VIN CHIP™ scanner by contacting VIN CHIP on tel: 0203 282 1000.

For help, support and advice, contact:

VIN CHIP

Catherine House

Victoria Road

Aldershot

Hampshire

GU11 1SS

Tel: 0203 282 1000

www.vinchip.co.uk

6. Arrival at site

6.1 Positioning the motorhome 36

6.1 Positioning the motorhome

Note: Check and observe site regulations.

Keep to roadways unless otherwise directed. Adhere to speed limits. Note that these are generally 10mph.

(Remember that the stopping distance on grass is considerably greater than on tarmac.)

Only a person in possession of a current driving licence may drive on the site.

Selecting a pitch

Do not pitch in such a position that your motorhome will obstruct others coming in.

Try to choose an area which is dry, reasonably level and preferably with a hard base.

If you have no alternative but to pitch on a slope try to ensure that you are facing down the slope, for when you leave.

Levelling the motorhome

Levelling must be carried out in both directions for the refrigerator and other equipment to function correctly. Stepped levelling boards (Fig. A) or proprietary ramps are ideal for this purpose. Levelling pads or boards should be used under the wheels where the ground is soft or uneven.



Fig. A

Awnings and Tents

Awnings and tents should only be used when permission has been obtained. When on grass and staying for more than a few days the ground sheet and/or side flaps of awnings should be periodically raised in order to avoid damage to the ground.

7. Connecting services

7.1 Water system - Introduction	38
7.2 Fresh water system	38
7.3 Priming the water system	39
7.4 Cleaning water system	39
7.5 Water Pump Pressure Switch	41
7.6 Waste water system	41
7.7 Tank heaters	42
7.8 Water level sensor & cleaning	42
7.9 The External Shower Point	43
7.10 Water fault finding	44
7.11 Gas Schematic	46
7.12 Gas	47
7.13 Types of gas	48
7.14 Changing a gas cylinder	48
7.15 External BBQ point	51
7.16 Gas fault finding	52
7.17 The electrical system	53
7.18 Overseas connection	53
7.19 230V mains electrical equipment power consumption	54
7.20 Connecting cable wiring	55
7.21 Typical appliance consumption	56

7.1 Water system - Introduction

All Swift Group motorhome water systems have been designed around a pump fitted within the motorhome. This pump draws water from an under floor or internal water tank, to provide water pressure within the water system, whenever it is switched on and water is available.

The schematic below shows the basic configuration of the water system:

WATER SYSTEM SCHEMATIC MOTORHOME WITH FITTED FRESH WATER TANK

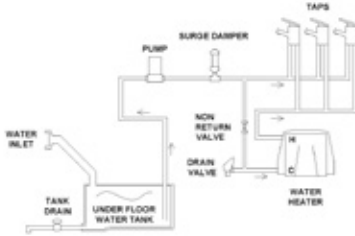

When power is supplied to the pump, it will draw water from the water tank, and pump it to the motorhome taps, shower and water heater.

The pump is fitted with its own pressure switch, and will continue to pump water, until the pressure of water on the output of the pump reaches a pre-set level. For this pressure to be achieved, the taps must be closed.

When the taps are opened, water will leave the tap via the spout, and the pressure in the pipes between the pump and the taps will reduce. Because of this reduction in pressure, the pressure switch on the pump will switch back on and the pump will again run to pump more water.

Close to the pump, the water under pressure is split into two paths:

1. Through blue water pipes routed directly to the cold connection of each tap.
2. To the water heater.

Water from the pump enters the bottom of the water heater. Once the water fills the water heater (typically 8 litres), water then leaves the water heater via a connection at the top of that water heater. This water, which is still under pressure, then routes to the hot connection of each tap via the red pipes.

To winterise the system please see separate details later in this handbook.

7.2 Fresh water system

All fittings, including the holding tank, water pipes, taps and connections are of food quality material (to BS6920) and therefore, should not affect the quality of the water used. It is recommended however, that the system is flushed through twice before it is used for the first time, and always cleaned/flushed after it has stood unused for a period of time (eg over the winter period). Care has been taken (using smooth bore pipes etc) to eliminate as many water traps as possible.

When filling the fresh water system remember to check that the water source is suitable for use as drinking water. If possible avoid using water sources which use desalination or other similar processing, as they may contain chemicals that could damage the stainless steel components within your motorhome water system. If in doubt, check locally before using a water supply.

The fresh water system is fitted with an electrically operated drain valve, which will drain the contents of the fresh water tank. The valve is controlled using a switch located in an upper locker, within the motorhome.

7.3 Priming the water system

When water is first introduced, or the water supply in the internal tank, runs out, air will be present in the pipework. It is important that every tap is run to remove any air in the system before, for instance, the shower is used. Air left in pipework local to a tap can act as an accumulator and affect the ratio of hot and cold water flowing from other taps or shower mixers in the system.

1. Close the water tank drain valve
2. Fill the water tank with water.
3. Close the water heater drain valve (see boiler instructions in the fitted equipment section)
4. Open all the taps except the shower tap. Mixer taps should be opened in the central position so that both the hot and cold pipes are purged of air. Ensure the tap spouts are over the sinks.
5. Turn on the pump using the button on the control panel (See pump button in the Electrics section).
6. Turn each tap off in turn as and when the air is expelled and the water runs smoothly from each tap. Move the mixer taps to hot and then cold to check that the air is out of both the hot and cold pipes before turning them off.
7. Whilst holding the shower head down towards the shower drain, open the shower tap and shower head tap until all the air is expelled and the water runs smoothly. Turn the shower taps off.
8. Top up the fresh tank with water.

Please note that priming the system will automatically fill the water heater with water.

Please ensure all taps are fully turned off when not in use (except when winterising).

Note: All tanks are fitted with a breather which acts as an overflow. Overfilling a tank will result in water being expelled from the overflow.

7.4 Cleaning water system

Clean the water system at the start and end of the season with sterilising fluid.

Sterilising

When cleaning the water system at the start or the end of the season it is advisable to use a suitable sterilising fluid available from your motorhome dealer. The fluid must be suitable for use with stainless steel components.

Do not use products that contain aggressive agents, bleach or sodium metabisulphite for sterilising the water system.

Always flush the system thoroughly to remove any traces of the cleaning fluids.

The water systems, and in particular storage tanks, in motorhomes are susceptible to contamination by bacteria if care is not taken with their use and cleaning. The symptoms caused by bacterial contamination are not purely limited to gastro-intestinal diseases, but may also manifest themselves as ear, nose, throat, eye or skin infections. It is therefore important that you carry out the following procedure prior to using the motorhome each time, even if you boil or filter all water you use for drinking.

Separate Water Containers

1. All water remaining in the container should be disposed of so that the container is empty.
2. The outside of the container should be thoroughly cleansed and washed down to remove any dirt, dust or other contaminant. Water at a suitably hot temperature containing an appropriate detergent is recommended for this purpose.
3. Water should be put in the container, swirled around, then emptied out.
4. The container should then be totally filled with sterilising fluid mixed to the strength recommended by the manufacture of the sterilising fluid and allowed to stand for the recommended contact time.
5. The solution should be emptied from the container.
6. The opening of the container should be cleaned thoroughly with an appropriate prepared wipe impregnated sterilising fluid.
7. The container should be inverted whilst stored overnight (if possible).

- The container must be filled with mains water only and mains water only should be used for the above cleaning procedure.
- On no account should garden hoses be used to fill water tanks.

Motorhome water systems

- Drain down the system by opening the tank drains and boiler/water system drain. (See section 7.2 for water tank draining) Open all taps to allow air into the system to enable the water to drain more quickly.
- Remove any water filters fitted, and replace with a short length of hose or empty filter cartridge (this will ensure the filter is not affected by the sterilising fluid).
- Fill the water system with sterilising fluid mixed to the strength recommended by the manufacture of the sterilising fluid. (check that the solution at full strength appears at all taps/showers). Allow to stand for the recommended period of time.
- Drain the system completely.
- Thoroughly clean the outside of all taps/ connectors with a cloth soaked in the disinfectant/sterilant.
- Flush the system through with clean drinking water until no traces of sterilising fluid can be detected at any tap.

CAUTION: Never use the water heating system when sterilising fluid is present. Doing so may damage the system.

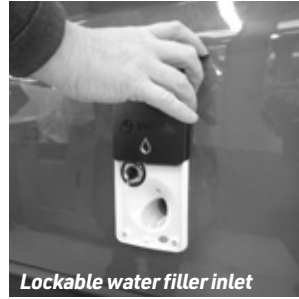

Lockable water filler inlet

Fresh Water Tank

Your motorhome is fitted with a water tank filled from the outside via a lockable water filler cap. When filling, use a hose manufactured from non toxic material, to prevent tainting of the water. Remember, if the water heater has been drained it will require 8 litre (1.7 gal) of water to fill it. Within the inlet is a 12V socket which can be used to attach an external 12V filling pump (pump not supplied).

Boiler / Water System Drain

The boiler / water drain valve is located in the rear nearside bed base (offside bed base in XL). To drain the system rotate the Yellow handle to the position shown below.

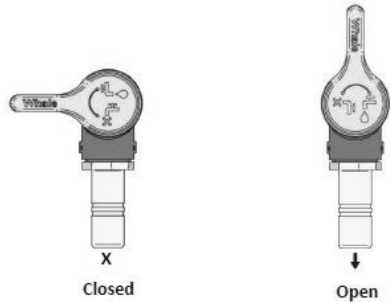

7.5 Water Pump Pressure Switch

The purpose of a pressure switch is to monitor the pressure on the outlet side of the pump. When a tap is closed, and the pump continues to run, there is an increase of pressure in the system, and when that pressure reaches a pre-set limit, the pressure switch will turn the pump off.

Pressure switch adjustment

Pressure Switch Adjustment, Truma/Flo-Jet pump. (Normally Grey upper section with White lower section/valve housing)

- All of the Truma/Flo-Jet pumps used by Swift are pre-set at 25psi - 31psi.
- To further adjust the pressure switch setting, a cover cap must be first be removed from the end of the pump to reveal a pressure adjusting screw, as shown in the photos. A maximum of 1/4 turn clockwise or anti-clockwise, from the factory setting, is advised. Turning the screw clockwise 1/4 turn will increase the pressure switch cut-out pressure, turning the screw anti-clockwise will reduce the pressure setting. Please note a second screw mounted below the cover cap is set in position with threadlock, this should not be disturbed.

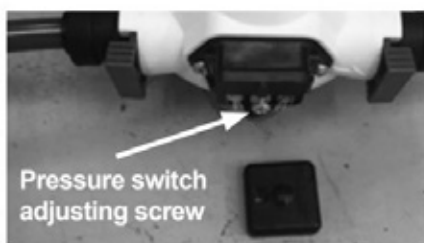

The pump may have to be removed to gain access to the adjusting screw. Drain the water system before removing the pump. To remove the pump pull the blue taps at right angles to the pipe work and lift the pump out.

7.6 Waste water system

1. The waste water holding tank is secured below the floor of the motorhome, and is gravity fed.
2. In order to eliminate unpleasant odours as much as possible, only smooth bore pipes are used.

Should the waste water tank be overfilled, it is possible that waste water will backfill the pipes until it eventually appears in the shower tray. In order to prevent this, please monitor the water level gauges on the motorhome control panel. It is also possible to enable a 'waste tank full' alarm, on the control panel.

The waste water tank is fitted with an electrically operated valve, which when opened will drain the contents of the waste water tank. The valve is controlled using a switch within the motorhome, located in an upper locker.

7.7 Tank heaters

Depending on specification, your motorhome may be fitted with 12v tank heaters, designed to prevent or reduce instances of freezing water in fitted water tanks.

If tank heaters are fitted, they can be turned on via the control panel feature above the entrance door (see 8.6). Turn this feature on when the external temperatures are low, and the tank heaters will then turn on and off automatically.

Before heating each tank the system will check that the water level in each tank is at the 1/4 level or higher (the heaters will not operate if the tank is 'empty'). If the water level is appropriate, the heaters will then switch on and off depending on temperature.

As the tank heaters check the water level in each tank, the fresh and waste water tank heaters can operate independently, for instance use of frost protect feature while the fresh tank is full, but waste tank is empty, would only result in the operation of the fresh tank heater.

It is also possible to use the tank heaters en-route, i.e. while driving. With the control panel ON, turn on the tank heaters as described above. While the engine is running the control panel cannot be operated, however, the tank heater circuits will remain ON.

Please note that the heating elements use a 12V supply. With the engine off, and if used without a mains hook up and charger operating, then leisure battery power consumption will be increased (see 7.21 for more information).

7.8 Water level sensor & cleaning

Principle

The sensors fitted to Swift Group motorhomes are mounted on the water tanks, and link to the power supply unit, via a pre-fitted wiring harness. These can be in the format of rod, stud, or float switch types.

The rod type sensors consist of a number of stainless steel rods, at different positions, suspended from the top surface of the tank and immersed in the water contained within the tank. They use the conductivity of water, between the rods, to provide a reading to the control unit.

The stud type sensors are similar, except they are mounted in the side of the tank at differing heights. As with the rod type, the conductivity of water between the studs is used to provide a reading.

A final, float type, is also mounted in the side of the tank. These multiple switches are 'on' or 'off' depending on the level of water within the tank, relative to their height on the side of that tank.

The rod and stud sensors are 'digital', in that while the conductivity (resistance) value can vary, the power supply unit will register any conductivity between the rods or studs, indicating water present. Normally, even if the rods or studs are dirty, providing they are not bridged by a foreign object, a circuit will still be delivered back to the control unit and a water level displayed.

Sensor cleaning

The first step, in case of fault diagnosis, is to clean the inside of the tank and/or sensors. False water level readings at the control unit can be caused by calcium build-up or foreign objects within the tank bridging the rods or studs, or, preventing the movement of float switch.

Your dealer will be able to assist in the purchase of cleaning solutions for the water tanks, those products being safe for use in drinking water supplies, and not containing chemicals which could damage the stainless steel components within the water system.

7.9 The External Shower Point



The external shower point will be supplied with a separate shower head and hose assembly.

To connect the shower hose, simply slide the lid on the housing up and remove the blank cap by pushing the blue Hozelock fitting forward and pulling the blank out. Screw the male Hozelock fitting (supplied) on to the end of the hose screw thread and then push into the female fitting inside the housing.

To remove, push the blue Hozelock fitting forward and pull the male fitting on the hose from the housing. Replace the blank cap.

7.10 Water fault finding

Fault	Cause	Remedy
Water not flowing from any tap when operated but pump runs	<p>Freshwater tank empty</p> <p>Pump wired in reverse</p> <p>Pipe inlet or outlet pipe disconnected</p> <p>Pump pipes restricted by kinking</p> <p>Blockage in pump inlet or outlet pipe</p> <p>Blocked pump filter</p> <p>Air leak in suction line to pump</p>	<p>Check</p> <p>Check wiring, refer to pump manufacturers instructions</p> <p>Check connections</p> <p>Check pipes run</p> <p>Check, starting inside freshwater tank</p> <p>Dismantle and clean filter. See pump manufactures instructions.</p> <p>Check condition of pipe and pipe joints between the water tank and the pump.</p>
Pump does not run	<p>Pump incorrectly wired</p> <p>Pump fuse blown</p> <p>Battery disconnected</p> <p>Pump seized or overheated</p> <p>Pressure pump sensing switch may have failed</p> <p>Contacts may be faulty</p> <p>Wiring connections may be faulty</p>	<p>Refer to pump manufacturers instructions</p> <p>Check wiring connection and then replace with fuse of correct rating</p> <p>Check connections</p> <p>Refer to pump manufacturers servicing instructions</p> <p>Refer to pump manufacturers servicing instructions</p> <p>Check contacts in plug and socket are clean and making contact</p> <p>Check wiring connections</p>
Water flows from cold tap but not from hot	<p>Blockage in hot pipeline</p> <p>Heater inlet or outlet pipes kinked preventing flow</p> <p>Hot tap failed or blocked</p> <p>Heater non-return valve jammed</p>	<p>Disconnect pipes and inspect</p> <p>Check and re-route if necessary.</p> <p>Disconnect and inspect</p> <p>Seek service attention</p>

Fault	Cause	Remedy
Water flows from hot tap but has reduced flow from cold	Cold water pipe kinked preventing flow	Check and re-route if necessary
	Blockage in cold pipe line	Disconnect pipes after 1st connector and check up to tap
	Cold tap not connected	Refer to installation instructions
	Cold tap failed or blocked	Disconnect and inspect
Reduced flow from both hot and cold taps	Battery condition low causing pump to run slowly	Check battery state of charge, refer to electrical supply note
	If new taps have been fitted they may be restricting flow	Disconnect and check that they have at least 1/4" (6.3mm) bore
	Pump needs servicing	Refer to pump servicing instructions
	Partially blocked pump filter or in-line filter, if fitted	Dismantle and clean if necessary
	Pump outlet pipe kinked restricting flow	Check and re-route if necessary
Reduced flow from either tap	Water leak	Check all water connections
	Pipe kinking restricting flow	Check and re-route if necessary
If pump motor runs steadily and will not stop	Bore size difference in taps	Use taps of equal bore size
	Battery voltage may be too low (below 10.5 volts)	Check that there is water in the container Adjust switch and/or re-charge battery. Check all connections in pipework

7.11 Gas Schematic

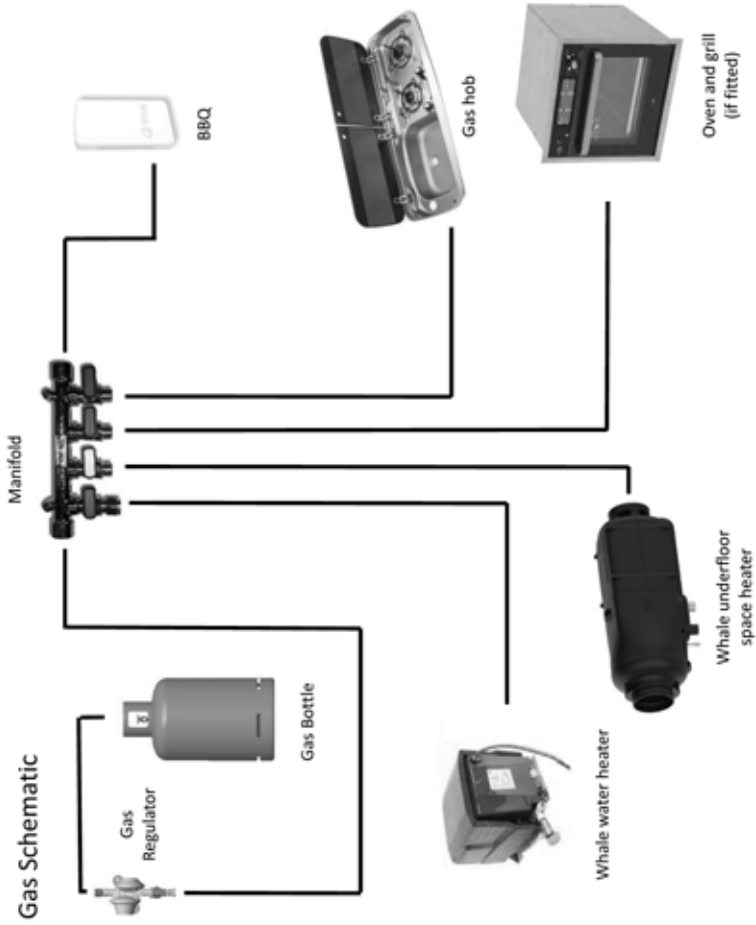

7.12 Gas

General information Gas Cylinders

Bottled Liquefied Petroleum Gas (LPG) is the most convenient portable source of fuel for your vehicle.

The gas cylinder, cooking and heating appliances should be isolated when travelling.

Regularly check flexible gas hose, joints and connections for tightness. Finally make sure that each gas appliance is working efficiently to the recommendations of the appliance manufacturers.

The LPG system should be inspected annually by a competent person.

Only use gas cylinders that are located within their dedicated position within the gas bottle housing never extend the hose - hose lengths must not exceed 400mm.

Your vehicle is supplied with a wall mounted gas regulator plumbed inside the gas bottle compartment. The regulator and all appliances work at a harmonised 30mb pressure, which work with Butane and Propane gas.

Pressure regulation system in this vehicle has a fixed working pressure of 30 mbar with a flow rate of 1.5 kg/H and complies with the requirements of EN 12864 annex D.

We do not recommend the use of an inline LPG BBQ with the 1.5kg/H regulator when other LPG appliances are in use.

Gas Hoses

High-pressure hoses or pigtails as they are called must be used with the new style regulator.

LPG cylinder i.e. Propane, Butane, BP and Camping Gaz cylinders all have unique bottle adaptor connections. It is important to check you have the correct hose and adaptor to suit your gas cylinders.

Push on hoses are no longer permitted under the latest regulations.

The high-pressure hoses have threaded connections and must be securely attached to the regulator and to the gas cylinder.

The hose connection to the pressure regulator relies upon a sealing washer(s) to maintain a gas tight joint, and it is essential to check that the washer is present, sound and correctly positioned prior to making the connection. The gas cylinder connection relies on a metal seating or bull nose connection to obtain a gas tight joint, therefore it is essential that the mating surfaces are clean and undamaged. In no case should a damaged valve or connection be used.

Ensure that there is a constant rise in the flexible gas hose between the gas cylinder outlet and the regulator elbow.

⚠ WARNING: Inspect flexible gas hose(s) regularly for deterioration and renew as necessary with the approved type, in any case no later than 5 years after the date of manufacture marked on the hose.

⚠ WARNING: Ensure that the high pressure hose is not excessively twisted or under stress when connected to the LPG cylinders and regulator.

⚠ WARNING: Always ensure the gas supply is isolated at the LPG cylinder (and not at the regulator) whilst the vehicle is in storage for any period. It is important to ensure that the high pressure gas hose has a continuous rise from the bottle cylinder to the regulator to allow any condensate to fall back into the gas bottle cylinder.

Cylinder compartment

Some cylinder compartments have four plastic mouldings per cylinder position fitted to the floor of the compartment that are designed to fit both steel and BP Gas Light cylinders. Either two straps are provided for retaining the bodies of the cylinders at mid to high level or a single 'holding ring' strap is provided which secures the gas cylinder to the base of the compartment.

7.13 Types of gas

Propane

Propane is supplied in red, or partly red cylinders which have a female left hand threaded connector.

Scandinavian countries use the same connector.

Germany and Austria supply propane with a male connection.

Propane will work at temperatures as low as -40°C and is therefore suitable for all winter motorhoming.

Note: For the Trekker models Swift recommend 6kg propane gas bottles are used.

Butane

Butane is supplied in the U.K. in green or blue cylinders.

All these have a male left hand thread

EXCEPT for Camping Gaz which has a special female right hand thread and Calor 7kg and 15kg and aluminium bottles which have a special clip-on connection.

Continental cylinders usually have a male left hand thread similar to but not identical with U.K. butane.

Butane is only suitable for use at temperatures down to 2°C but will not work below that.

7.14 Changing a gas cylinder

Please use the correct size spanner for the gas hose connectors as this will prevent damage to the screw fittings and ensure that the fitting is tightened sufficiently.

- Turn off gas appliances
- Close the empty gas cylinder's valve
- Remove the high pressure hose from the gas cylinder.
- Attach the high pressure hose to the full gas cylinder.
- Open the full cylinder's valve.

Check the hose connection to the cylinder valve for leaks.

⚠ WARNING: When re-fuelling your motorhome, switch off the heater and close the cylinder valve.

Note: Modifications, servicing and repairs must only be carried out by a competent service engineer.

Note: The regulator should be replaced no more than ten years after manufacture.

⚠ WARNING: When travelling all LPG appliance shut off valves must be in the closed position.

Note: It is dangerous and illegal to operate LPG appliances whilst travelling.

⚠ WARNING: Never allow modifications or repairs of electrical or LPG systems and appliances except by qualified persons.

Note: When replacing the high pressure hose from the bottle to the regulator, purchase only genuine Truma hoses.

Gas safety advice

⚠️ WARNING: If you smell gas or suspect a leak or in the event of a fire and if it is safe to do so, isolate the gas appliances and turn off the gas bottles at the regulator. Evacuate the motorhome and ventilate. Seek professional advice as to the cause of the leak.

Facts about LPG

- LPG is not poisonous.
- Bi-products are harmless.
- There is danger if all air and oxygen were excluded.
- (Ventilation holes must be kept clear at all times).
- LPG has been given a smell by the manufacturers in order to identify leaks.

Awning Spaces LPG Appliance Exhaust

There is no danger of pollution of an enclosed awning space by the LPG exhaust from a refrigerator venting into it, as awning spaces are generally well ventilated.

Space heaters may produce sufficient exhaust to pollute the awning space, if it is totally enclosed, from a general comfort, smell and hygiene point of view. In the extreme case there could be a build up of carbon dioxide to a dangerous level.

Motorhome owners are advised to allow some fresh air circulation in the awning space when such appliances are in use.

General Safety Notes

In the event of leaks in the gas system or if there is a smell of gas:

- Extinguish all naked flames.
- Do not smoke.
- Switch off the appliance and gas cylinder.
- Open the windows.
- Do not operate any electrical switches.
- Have the entire system checked by an expert.

Precautions

- Never look for a leak with a flame. Always use a soap solution or its equivalent when testing connections. Do not operate any electrical apparatus whatsoever, especially light switches. If the leak is not obvious, the motorhome should be evacuated and qualified personnel consulted.
- Avoid naked lights when connecting or changing a cylinder.
- Check the flexible hose frequently.
- The gas is heavier than air and therefore sinks to the lowest point.
- Keep bottle gas containers outside (and protected against frost). If they must be kept inside make sure they are well away from heat.

⚠️ WARNING: Do not use appliances with a different working pressure to 30mbar.

⚠️ WARNING: Maintain adequate spacing of combustible materials from sources of heat.

⚠️ WARNING: Do not use independent portable gas appliances inside the vehicle. Cookers shall not be used as heaters

⚠️ WARNING: A BBQ point inlet valve, if fitted, must only be used for the connection of portable LPG appliances.

⚠️ WARNING: If in doubt ask for advice from a competent person.

Always read individual appliance instructions.

Connection

Ensure that the gas regulator hose is correctly connected to the gas cylinder in the gas bottle compartment and that the hose connection is tight.

Gas cylinders must be fully located, seated at the base of the bottles and restrained by the straps provided in the dedicated compartment position.

⚠ WARNING: If using cylinders other than those recommended, the user must ensure these are adequately supported, ventilation openings must not be obstructed and the cylinders must not cause damage to other fixtures

Open ended gas hoses must always be protected from dirt and insects.

Before turning on the gas supply at the regulator, ensure that all gas operated equipment in the motorhome is turned off.

All gas equipment is supplied through a Gas Manifold System which has individual isolation taps for each appliance (Fig A), as follows:

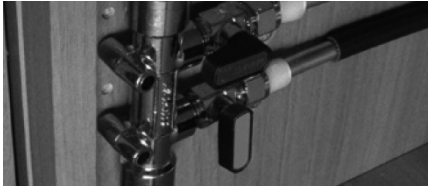

Fig. A

 GB: GAS TAP NL: GASKRAAN - DE: GASHAHN FR: ROBINET GAS	
 YELLOW GB: HOB NL: KOOKPLAAT DE: KOCHER FR: CUISINIER	 WHITE GB: HEATER NL: VERWARMING DE: HEIZUNG FR: CHAUFFAGE
 GREEN GB: OVEN NL: OVEN DE: OFEN FR: FOUR	 RED GB: HOT WATER NL: WARM WATER DE: HESSES WASSER FR: EAU CHAUDE
 BLUE GB: FRIDGE NL: KOELKAST DE: KÜHLSCHRANK FR: FRIGO	 WHITE GB: COMBINATION BOILER NL: COMBIBOILER DE: KOMBINATIONSHHEIZUNG FR: CHAUFFAGE COMBINÉ
 GB: OPEN NL: OPEN DE: OFFEN FR: OUVERT	 GB: CLOSED NL: GESLOTEN DE: ZU FR: FERMÉE

Note: If the motorhome is in storage or not being used for a period of time, we recommend turning off the gas supply at the gas bottles.

Flue installations

All flue installations should be inspected once a year throughout their length for corrosion. Flues should be replaced if any sign of perforation is found. Ensure that the replacement is of an approved type.

⚠ WARNING: Where a flue terminates below the floor it is essential to allow free evacuation of the products of combustion at all times. Ensure it is kept clear and the area around it unobstructed especially by snow.

Thermal insulation heating

See the motorhome technical section for the classification of your motorhome.

The classifications are as follows:

Grade 1

A motorhome with an average thermal transmittance (u) that does not exceed 1.7W/m²K.

Grade 2

A motorhome with an average thermal transmittance (u) that does not exceed 1.7W/m²K and which can achieve an average temperature difference of at least 20°C between inside and outside temperatures when the outside temperature is 0°C.

Grade 3

A motorhome with an average thermal transmittance (u) that does not exceed 1.2W/m²K and which can achieve an average temperature difference of at least 35°C between inside and outside temperatures when the outside temperature is -15°C.

7.15 External BBQ point

Models equipped with an external barbeque point can be used to power any gas appliance suitable for the gas used in the motorhome, at the working pressure shown on the label in the barbeque outlet box. Please note when using the outlet that the fitted regulator will allow a maximum of 1.5kg per hour of gas to be taken from the gas bottle. Therefore the consumption of gas from both the appliances within the motorhome and the appliance connected to the barbeque point cannot exceed a total of 1.5kg per hour at any one time. If you are in any doubt please consult your dealer for advice. To use point proceed as follows:

1. Fit male tail connector from despatch kit to your barbeque or appliance ensuring a gas tight joint. The work should be carried out by a competent person; if in any doubt consult your dealer.
2. Open box lid by sliding up from the bottom.
3. Insert tail connector on appliance into female coupling, twist to engage and lock.
4. Open gas locker on caravan, ensure gas bottle tap is open and supply is connected to regulator.
5. Light and operate appliance to its instructions. Please note that you cannot open the gas supply until the nozzle has been inserted. In the interest of safety all external hose lengths should be kept to a minimum and attachments secured correctly.

⚠ WARNING: Care should be taken when using the external barbeque point. Never barbeque next to an awning or tent.

⚠ WARNING: The motorhome barbeque point should only be used as an outlet point for gas, never connect a gas bottle direct to the outlet.

7.16 Gas fault finding

Fault	Cause	Remedy
Hob does not light	No gas	Check level of gas in cylinder Check gas cylinder valve is on Check gas taps are on
	Air in pipe	Purge system Refer to hob manufacturers instructions
Oven (if fitted) does not light	No gas	Check level of gas in cylinder Check gas cylinder valve is on Check gas taps are on
	Air in pipe	Purge system Refer to oven manufacturers instructions
BBQ does not light	No gas	Check level of gas in cylinder Check gas cylinder valve is on Check gas taps are on
	Over gassed Air in pipe	Turn off appliance, wait 2 minutes and try again Purge system
Space & water Heater does not light	No gas	Check level of gas in cylinder Check gas cylinder valve is on Check gas taps are on
	Water heater only Air in pipe	Purge system Refer to water heater manufacturers instructions

7.17 The electrical system

General Information

It is strongly advised that the mains installation is inspected periodically to ensure safe use. The IET (BS7671) wiring regulations recommend that mains installations in motorhomes are re-inspected every 3 years or annually if the van is used frequently. The National Caravan Council lists the qualifications necessary to perform this inspection, but an NICEIC approved contractor is probably the first choice.

On arrival at the campsite

- Check the suitability of the supply, is it AC or DC, is the voltage and frequency correct.
- Ensure that there is a proper earth (3 pin socket outlet).
- If in doubt consult site staff.
- Make sure that the supply from the site is switched off.
- Make sure that the charger switch on the PSU is switched off.
- Slide up the cover from the bottom on the electricity inlet on the motorhome, and insert the connector on the flexible supply cable.
- At the site supply point, connect the other end of the supply cable to this using the socket provided.
- Switch on the main switch at the site supply point.

Note: It is good practice to test the RCD (Residual Current Device) in the PSU before switching on. There is a test button on the RCD to test the lever, put the lever in the up position (on) before testing.

Note: As with the RCD it is good practice to check the Miniture Circuit Breaker (MCB) in the PSU. Switch all to the on position (lever up). If any do not stay up then there is a fault.

On departure from the campsite

- Switch off supply from the site, disconnect the cable at both ends.
- Switch off RCD.

Note: Never use a mains supply lead whilst coiled. Always uncoil the full length before connecting to the supply and remember to protect the cable from traffic.

⚠ WARNING: Current consumption in the motorhome must not exceed 16 amps or the pitch permitted maximum if this is less than 16 amps.

7.18 Overseas connection

- Connection to a mains voltage overseas requires particular attention.
- Overseas supplies can be of reverse polarity.
- Reverse polarity results in equipment not necessarily being isolated when turned off, reverse polarity indicator on the PSU will light in the event of reverse polarity.
- The only sure way to make equipment safe is to unplug it.
- It is useful to have a means of checking polarity when overseas.
- If it can be achieved then connect live to live, and neutral to neutral to achieve full electrical protection.

⚠ WARNING: Never allow modifications or repairs of electrical or LPG systems and appliances except by qualified persons.

7.19 230V mains electrical equipment power consumption

Please note:

It is possible that the 230V mains electrical equipment may not all operate simultaneously. A typical UK motorhome site mains hook up point provides a maximum output of 10 amps and on some continental sites the available output may be as low as 5 amps.

If your loading exceeds the site supply it may trip the site circuit breaker. Please check the available mains output with your site operator.

Similarly loadings on each circuit breaker within the vehicle should be observed.

A label positioned close to the MCB's will identify which appliances within the vehicle are fed from which MCB. Consulting the table (Typical Appliance Consumption Figures) in conjunction with this label, will give an indication of which appliances can, and cannot, (site supply allowing), be operated simultaneously.

7.20 Connecting cable wiring

Wiring of connecting cable and motorhome mains inlet

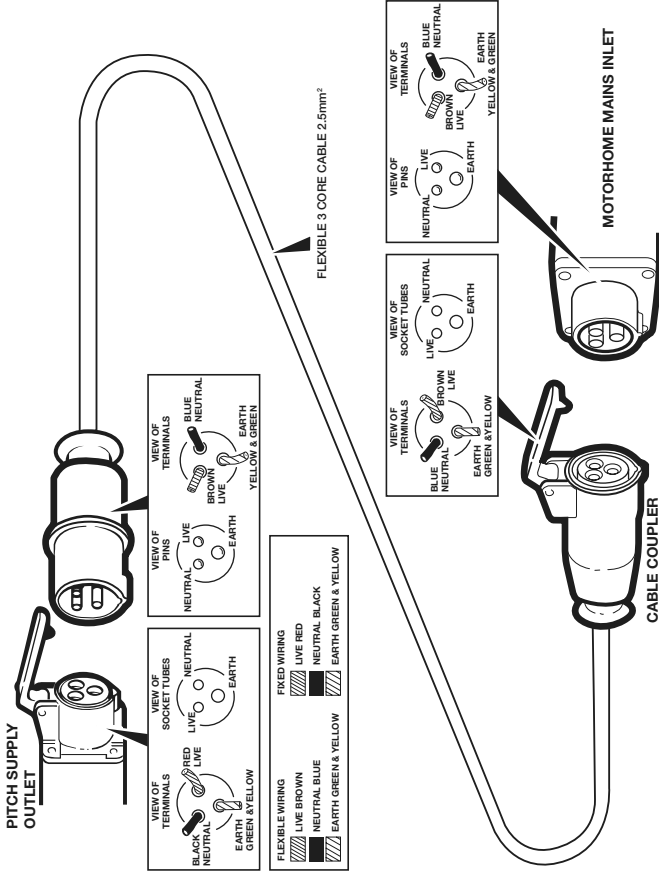

The legal length of the mains inlet cable is 25 ± 2 metres. When in use it must be fully uncoiled and protected from traffic.

7.21 Typical appliance consumption

Appliance/ Item	230 Volt		12 Volt		LP Gas grams/hour
	Watts	Amperes	Watts	Amperes	
Dometic RC10.4T Refrigerator (when fitted)	Not applicable	Not applicable	Up to 42 W	Up to 3.5 amps	Not applicable
Dometic NRX50 Refrigerator (when fitted)	Not applicable	Not applicable	Up to 48 w	Up to 4.0 amps	Not applicable
Whale Heat Air GE space heater	750 / 1500 / 3000 W	3.2 / 6.5 / 13 amps	7.2 to 78 w	0.6 to 6.5 amps	Up to 436 g/hr
Whale Expanse water heater	750 / 1500 W	3.2 / 6.5 amps	6 w	0.48 amps	100 g/hr
Dometic hob burners	Not applicable	Not applicable	Not applicable	Not applicable	73 – 160 g/hr each
CAN Oven	Not applicable	Not applicable	Not applicable	Not applicable	95 - 131 g/hr
Battery Charger	690 W	3.0 amp	Not applicable	Not applicable	Not applicable
12v LED lights (each, depending in size of light)	Not applicable	Not applicable	0.4 w - 6.1 w	0.05 amp – 0.5 amp	Not applicable
USB socket	Not applicable	Not applicable	Up to 18w	Up to 1.5 amps	Not applicable
Water tank frost element (Winter pack)	Not applicable	Not applicable	3.0 W	2.5 amp each	Not applicable
Pressure switched water pump	Not Applicable	Not Applicable	24 w	2.0 amp	Not applicable

Note: These are approximate figures for guidance only, and are subject to changes in specification. The figures show energy consumption when an item or appliance is operating – i.e. a light is illuminated, or a heating system is providing space heating or water heating. Appliances which feature LCD or illuminated control panels can have a low current consumption when in stand by mode, or have a constant low current draw in the background to run their displays and electronic systems - these figures are typically 0.4 amps or less, for each applicable item. These electronic items can in most cases be switched off individually, or, use of the System Shutdown button on the power supply unit isolates all of these items.

8. Preparing for the road

8.1 Motorhome battery	58
8.2 Battery removal	59
8.3 EC940 Power Control System	60
8.4 Using the System	60
8.5 Control Panel - Layout	62
8.6 System Warnings	68
8.7 System Technical Information	71
8.8 Common Fault Table	77
8.9 Technical Data & Approvals	79
8.10 Approvals	80

8.1 Motorhome battery

Your motorhome has been fitted with a sealed, Absorbed Glass Matt leisure battery which is specially designed for installing on its side and without ventilation. The battery should only be positioned in the compartment under the rear traveling seat, and be properly secured before travelling.

It is recommended that a good quality leisure battery is always connected when the motorhome electrical system is in use.

Leisure batteries are a deep cycling rechargeable heavy duty 12v battery designed to provide power for lights and other electrical appliances. Replacement batteries should be a proprietary brand leisure battery with a 85amp - 110 amp capacity.

⚠ WARNING: When renewing a leisure battery care should be taken ensuring that a fully sealed Absorbed Glass Matt battery, which can be fitted on its side is used. IF UNSURE SEEK ADVICE Other types of leisure batteries contain a liquid and electrolyte which will leak out if laid on its side. CONTACT WITH THE LIQUID ACID CAN CAUSE SEVERE INJURIES AND DAMAGE TO THE VEHICLE.

Note: Replacement batteries should be checked dimensionally before purchasing, to ensure fitment within the battery compartment, as brands vary in size.

It should be remembered that batteries suitable for the electrical demands of a motorhome differ in design from those for use with a car, and whilst the system may operate with a car battery it is strongly recommended that only a rechargeable leisure type battery, maintained in good condition is used.

⚠ WARNING: When connecting the battery, ensure that the correct polarity is observed (black is negative and red/brown is positive) and that the terminals are securely fastened.

Under normal circumstances it should not be necessary to remove the battery other than for routine inspection of terminals.

Your motorhome has been fitted with an in-line 40 amp fuse between the battery terminal and the power supply unit. Do not use a higher rated fuse as this may cause damage to your motorhome.

⚠ WARNING: Switch off all appliances and lamps before connecting or disconnecting the battery. Open flames and smoking are prohibited around the battery compartment.

To preserve the life of your leisure battery and charger please observe the following:

1. Do not leave all 12v lights powered at the same time as this will drain your leisure battery more rapidly.
2. If all 12v lights must be powered together, ensure the battery is 'in-circuit' and that the battery charger is turned on.
3. For optimum performance use the transformer/charger unit with a leisure battery attached.

Please note the auxiliary battery or batteries supplied with your motorhome may not be fully charged and should be charged for a minimum of 24 hours before use.

Battery performance may be affected by a number of things such as ambient temperature, age, state of charge etc.

⚠ WARNING: It is imperative that the battery is correctly secured as any movement could cause wear to the casing and cause electrolyte to leak.

⚠ WARNING: For your own safety do not store anything other than the leisure battery in the battery compartment under the rear travelling seat.

8.2 Battery removal

The leisure battery is housed in the travel seat (rear offside bed on XL). Please be aware the leisure battery is in excess of 25kg in weight, care is needed manoeuvring the battery, please ask your dealer for assistance.

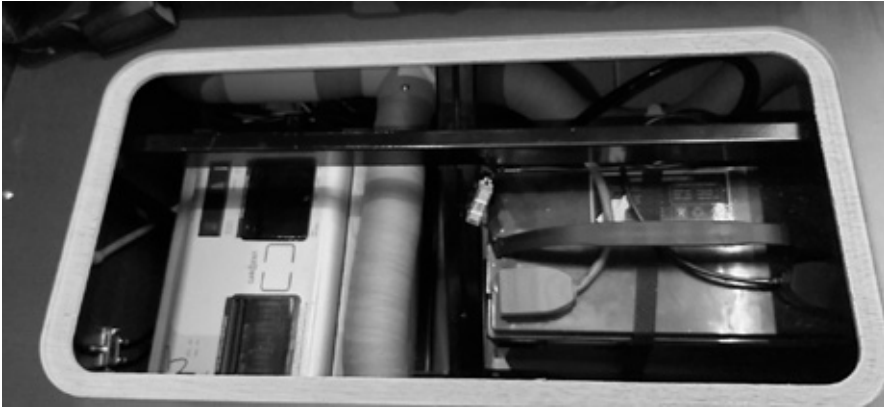

The battery is held in place by a tie-down strap that loops over the top of the battery.

Basic steps to follow for removal/replacement are:

1. Locate 40A fuse, by following the Red cable from the positive battery terminal, until the fuseholder containing the Orange 40A fuse is found. Remove the fuseholder cover, and pull out the fuse.
2. Using a socket set, remove first the negative terminal and then the positive terminal from the leisure battery. Ensure the tools used do not create a short circuit across the battery terminals.
3. Release the strap that loops over the leisure battery, by passing the strap through the buckle. Carefully lift the battery out of the seat base, taking appropriate care with the weight involved.

When fitting the replacement battery:

4. Manoeuvre battery into position
5. Secure with strap
6. Secure the positive terminal, and then the negative, onto the battery posts, taking care with the polarity: Not all batteries have the same orientation of positive and negative terminals. Ensure the tools used do not create a short circuit across the battery terminals.
7. Re-position the Red and Black insulating covers over the positive and negative connections, securing with a tie wrap if required.
8. Replace the 40A fuse and its protective cover.

Note: Any replacement auxiliary battery shall of the same type and specification as the original fitted or specified by Swift.

8.3 EC940 Power Control System

This section of the handbook will guide you through the operation of the electrical system. All details are correct at the time of going to press. Please also see the online version which will include any later updates or amendments.

Further technical details are contained in section 8.8 or in the supporting technical manual available from www.sargentltd.co.uk

For the safe operation of all electrical equipment within your Leisure Vehicle it is important that you read and fully understand these instructions. If you are unsure of any point, please contact your dealer / distributor for advice before use.

The system has a number of key components that you will need to be familiar with before attempting to use the system, these are:

- The EC403PSU, EC454PSU or EC456PSU Power Supply Unit (PSU) - a combined mains consumer unit and 12V controller usually located in a storage area (lower bed box, wardrobe or similar).
- The EC940 Control Panel (CP) - a remotely located user control panel used to turn circuits on and off and to display battery, water tank and other system information. This panel uses a graphical touchscreen with straightforward controls and reliable data communication to the PSU.
- The PX300 Intelligent Battery charger 300W (when fitted)
- The PX310 Intelligent Battery charger 300W (when fitted)

8.4 Using the System

Power Supply Unit - Component Layout

The PSU is usually located in the front offside bed box area.

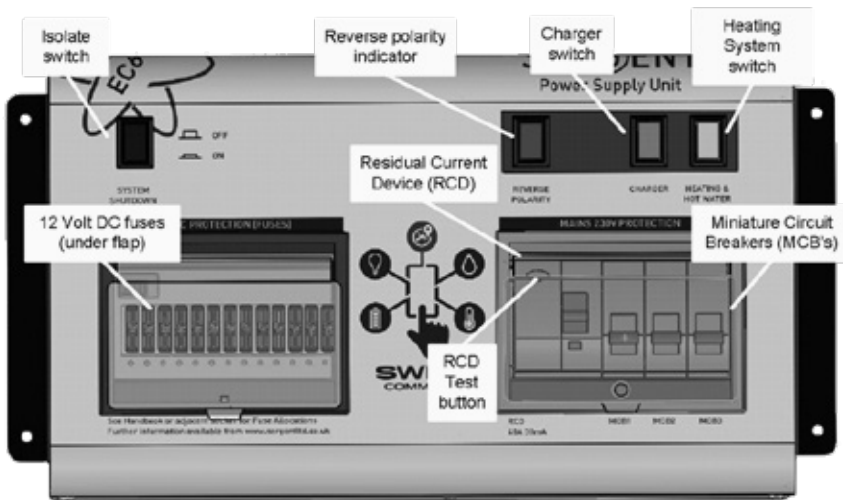

Activating the System

The system has a shutdown feature that can be used when the vehicle is in storage. This allows the leisure electronics to be turned off when not required to avoid flattening of the leisure and / or vehicle battery.

When in the off state only the alarm and tracking system supplies are still active, all other supplies are turned off.

Before using the system, please ensure the system shutdown switch is in the on position (button in) the system is now active.

Connecting to the Mains 230V supply and Safety checks

For your safety it is IMPORTANT that you follow these connections instructions each time your Leisure Vehicle is connected to a mains supply. This section assumes that the system is complete and that a Leisure battery has been installed.

A) Ensure suitability of the Mains Supply.

Your Leisure Vehicle should only be connected to an approved supply that meets the requirements of BS7671 or relevant harmonised standards. In most cases the site warden will hold information regarding suitability of supply. If using a generator, you also need to comply with the requirements / instructions supplied with the generator. Please note that some electronic generators may not be compatible with your leisure system. Further generator operational information is contained on section 8.8.

B) Switch the PSU Battery Charger / Power Converter OFF.

Locate the green 'Charger' power switch on the PSU and ensure the switch is in the off position (button out) before connection to the mains supply.

C) Connect the Hook-up Lead.

Firstly, connect the supplied hook-up lead (orange cable with blue connectors) to the Leisure Vehicle and then connect to the mains supply.

D) Check Residual Current Device operation.

Locate the RCD within the PSU and ensure the RCD is switched on (lever in up position). Press the 'Test' button and confirm that the RCD turns off (lever in down position). Switch the RCD back to the on position (lever in up position). If the test button failed to operate the RCD see section 8.8.

E) Check Miniature Circuit Breakers.

Locate the MCB's within the PSU (adjacent to the RCD) and ensure they are all in the on (up) position. If any MCB's fail to 'latch' in the on position see section 8.8.

F) Turn the PSU ON.

Locate the black 'Shutdown' button and ensure it is in the on position (press button in). Locate the green 'Charger' switch on the PSU and turn to the on position (press button in). The charger switch will illuminate when turned on.

G) Check correct Polarity.

Locate the 'Reverse polarity' indicator on the PSU and ensure that the indicator is NOT illuminated. If the indicator is illuminated see section 8.8.

H) Check operation of equipment.

It is now safe to operate the 12V and 230V equipment.

Operation while driving

The power control system is designed to shutdown parts of the system while the engine is running. This is to meet Electro Magnetic Compatibility (EMC) regulations and to ensure the safe operation of the motorhome. With the engine running the screen will show a warning 'ENGINE RUNNING'.

Please ensure the system shutdown switch on the PSU is in the on (button in) position before driving. This will ensure the electronic system is active and will therefore be able to control the charging process, supply the refrigerator and monitor other system circuits.





If / when fitted, designated 12V sockets, enroute reading lights and enroute heating will remain operational while the engine is running.



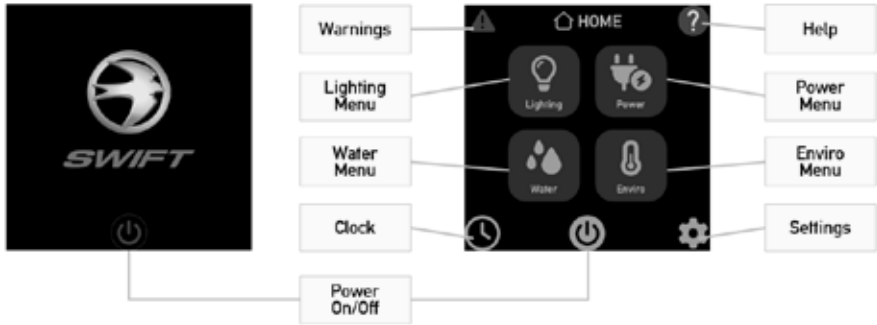





8.5 Control Panel - Layout

Your control panel will have an appearance as below, but depending on your vehicle specification the control panel features will vary. Not all features are present in all vehicles.

EC940 Control Panel



	<p>Power On/Off Button - After activating the PSU by pressing the System Shutdown Button the display will beep twice and show the Swift start-up logo. To activate power to all circuits, press the power on/off button, the panel will beep once. To turn the power off and enter standby mode, press the power button again. Note:- If the display has been inactive for some time, the backlight will be switched off to save power. Simply tap the screen to restore normal brightness.</p>
	<p>Lighting Menu - Press the lighting button to show the lighting control screen. Here you can turn on / off or adjust the dimmable lighting levels.</p>
	<p>Power Menu - Press the power button to show the power information and control screen. Here you can view leisure/vehicle battery condition, and check battery charger and solar charger currents.</p>
	<p>Water Menu - For vehicles fitted with inboard water tanks, press the water button to show the water tank information and control screen. Here you can view tank levels and control related features.</p>

 Pump	<p>Pump Button - For vehicles not fitted with inboard water tanks, press the pump button to turn the water pump on. Press the button again to turn the pump off. The button border will illuminate when the pump is on.</p>
 Enviro	<p>Environmental Menu - Press the enviro button to show the internal and external temperature in degrees Celsius. Also shown is the internal relative humidity.</p>
	<p>Warnings Button - The system incorporates a number of warnings, for example if the battery becomes low. When a warning is active a warning box will appear along with an audible beeping sound. Until the warning has been fully cleared, the warning indicator will remain Red. Press the indicator to view any active warnings.</p>
	<p>Help Button - Press the help button to display the context sensitive help screens. These will provide more detail about how to use the currently selected screen.</p>
	<p>Clock Button - Press the clock button to display the current time in 24hr format. This screen also provides status tiles for the leisure battery, fresh water tank, 230V mains and solar panel charging, where fitted.</p>
	<p>Settings Button - Press the settings button to show the general settings screen. Here you can set the date & time, screen brightness and screen on-time, key beeps etc. There are also buttons on this screen to pair or delete Bluetooth devices. Press the home button to return to the main screen.</p>
	<p>Advance button - Pressing this button will advance to the next main section, for example to move between Lighting, Power, Water and Enviro screens</p>
	<p>Next Button - Pressing this button moves to the next screen within a section, for example to move between Leisure and Vehicle battery screens</p>
	<p>Home Button - Pressing this button will go back to the Main Menu screen</p>

Clock / Status Screen

Clock screen - This screen not only displays the current time and date but also provides status tiles for the main services in the vehicle such as leisure battery and fresh water tank (if fitted)

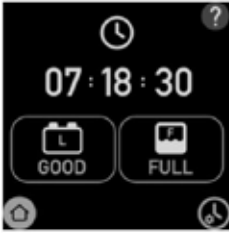

	Leisure Battery - The charge status is shown GOOD - No charge required FAIR - Charge recommended POOR - Charge immediately CHARGING - Charger is switched on DISCONNECTED - No battery detected
	Fresh Water (if fitted) - The water tank level is shown FULL - 100% GOOD - 50% to 99% LOW - 25% to 49% EMPTY - less than 25%
	Clock Setup - Press this button to access the clock setup screen

Clock setup - Use this screen to set the current time and date



	Set Time - Use the up / down arrows to set the required time
	Confirm settings - Use the tick to confirm the settings or cross to cancel the settings

① **Note:** the clock has a power backup, which can retain the clock settings for a number of weeks. If the vehicle has been stored for longer than this with no 12 volt power, the clock may need to be reset.

Environmental Readings

The EC940 system uses two sensors to measure internal temperature/humidity and external temperature. The combined internal temperature and humidity sensor is furniture mounted within the motorhome, and the external sensor is mounted below the motorhome floor. The figures displayed are for information only, and it is hoped the information will be useful.

For vehicles fitted with Alde or Truma heating systems, this sensor is not used to control the heating temperature, as it is measured separately above the door by the Alde or Truma room sensor. The readings on the heating system may vary relative to the one shown on the EC940 control panel.

For vehicles fitted with a Whale heating system, the sensor may be used to control the heating temperature as the system may not have its own sensor.



	Internal - The internal temperature and humidity is shown along with a bar graph
	External - The external temperature is shown along with a bar graph

Water System Operation

The EC940 control panel pump button operates the internal water pump drawing water from an on-board tank if fitted, or an external container when no tank is fitted.

The water tanks (fresh & waste) incorporate a level warning feature to warn the user when the fresh water level drops below 25% or when the waste water level reaches 100%. These warnings can be enabled / disabled from the User Settings screen.

If the water pump power is turned on and the fresh water level drops to below 25% a warning beep will be heard and a message will be displayed on the control panel. To cancel the warning, press the bell icon.

If the water pump power is turned on and the waste water level rises to full (100%) a warning beep will be heard and a message will be displayed on the control panel. To cancel the warning, press the bell icon.

These warnings will not be repeated unless the water pump power switch is turned off and on again. This is to ensure the warning does not become a nuisance.

Fresh Water Tank screen - Here you can view the on-board fresh water tank level and control water tank related features.

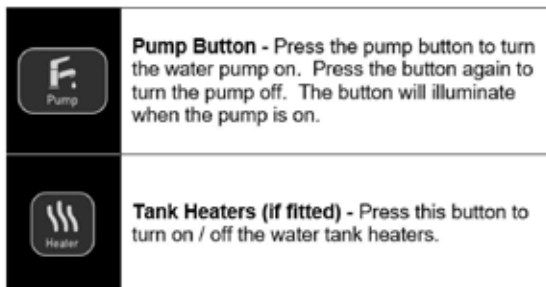

Waste Water Tank screen - Here you can view the on-board waste water tank level and control water tank related features.

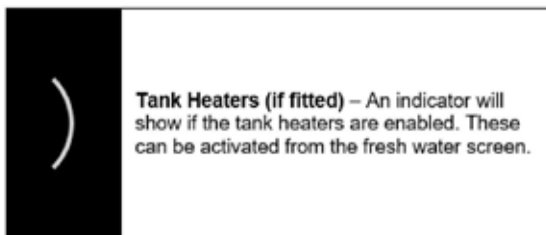

Lighting & Dimming Operation

The system contains one dimming channel for groups of lights which can be dimmed, turned on and turned off by this screen and can also be turned on and off by furniture mounted switches.

The entry light can be controlled from the local switch adjacent to the entry door (if fitted) or the control panel entry light button. Each item can toggle the light on or off.

The awning light can be controlled from a number of sources, the control panel awning light button or the lock and unlock system (dependant on system setting being set to do so). Each item can toggle the light on or off.

Lighting screen - Here you can turn on / off or adjust the dimmable lighting levels.



	<p>Dimmer Button - Press this button to turn the dimmable lighting on or off.</p>
	<p>Dimming Level - To change the dimming level, either press the (+) or (-) buttons or drag the slider to the required level. The dimming level is shown as a percentage.</p>

Power Management

The status of the leisure and vehicle batteries can be viewed on the control panel display by selecting the Power menu. Pressing the 'next screen' button will switch between leisure battery, vehicle battery and solar power.

The EC403PSU, EC454PSU or EC456PSU PSUs incorporate a built-in solar charge management feature, which will monitor the input from a separate solar panel and regulator if fitted. The current produced from the solar regulator is displayed along with an indication of which battery is being charged. Depending on the charge state of the batteries, the solar power will be directed to the required battery and continuously monitored to ensure optimum operation.

Battery Power screen (12V) - Here you can view battery levels, view charger and solar current and press the more button (right arrow) to view 230V current.



	<p>Selected Battery - Use the selected battery button to choose which battery you wish to use or charge with the 230V charger.</p>
	<p>Battery Condition - the battery condition will be shown on the dial and also described as below, GOOD - No charge required FAIR - Charge recommended POOR - Charge immediately CHARGING - Charger is switched on DISCONNECTED - No battery detected</p>
	<p>Battery Voltage - The voltage value will be shown together with a <u>bargraph</u></p>
	<p>Battery Current - The battery current will be shown together with a <u>bargraph</u></p>
	<p>Current Direction - A symbol will show if current is going into or out of the battery or if the battery is inactive.</p>

Solar Power screen (12V) - Here you can view the charging current being provided from solar panel (if fitted)

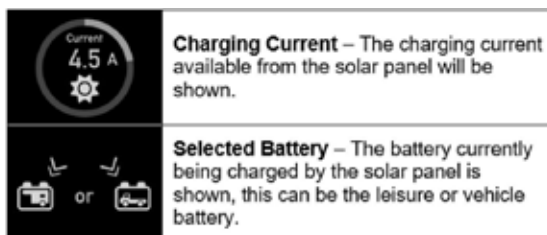

Solar Power screen (12V) - Here you can view the charging current being provided from solar panel (if fitted)

Smart Charging

The EC454PSU & EC456PSU incorporates a smart charge feature, which monitors both leisure and vehicle batteries and automatically adjusts and directs the charger power (and solar power if a solar panel is installed) to maintain the leisure and vehicle batteries at an optimal level.

Note: If the vehicle battery is isolated, some smart charging functionality will be lost, and the available charge will be directed to the leisure battery.

Electric Step Operation

On vehicles fitted with an electric step, this is operated by a button near the entry door. Press and release the button to move the step in or out. One press of the button will move the step out; a further press will move the step in again.

If the engine is started the step will move in automatically, after a short warning buzzer. If this operation fails due to an obstacle a buzzer will sound continuously to warn that the step is still out, and therefore requires your attention.

8.6 System Warnings

The system incorporates a number of warnings that are active at specific times. These are summarised in the table below and also covered by relevant sections of this manual.

Warning screens - When a warning is active a warning screen will appear on the control panel screen containing a description of the warning along with an audible beeping sound.









Example safety warnings

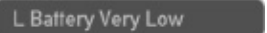

Example Power warnings

	<p>Active Warning – If a warning becomes active, it will be highlighted (Orange for power/water alerts and Red for safety alerts)</p>
	<p>Muting a warning – To mute the warning sound, press the bell icon next to the alert. The icon will then become Grey and the sounder will stop. Note that safety warnings can only be muted by correcting the cause e.g., removing mains lead whilst engine is running</p>
	<p>Clearing a warning – The warning will remain highlighted until it is fully cleared, for example by re-filling the water tank or re-charging the battery</p>

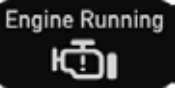
Warning	When	Type
Fresh water level low 	With pump turned on and fresh water level low (less than 25% full) Only available when an on-board tank is fitted	Message on screen and 60 second audible beep
Waste water level full 	With pump turned on and waste water level full. Only available when an on-board tank is fitted	Message on screen and 60 second audible beep
Leisure battery voltage low 	With control panel power on and leisure battery selected (as active battery) and the voltage level falls below 10V	Message on screen and 60 second audible beep.

Warning	When	Type
Leisure battery voltage very low 	With control panel power on and leisure battery selected (as active battery) and the voltage level is below 9V	Message on screen and 60 second audible beep. If no action taken after 30 seconds, then the system will switch the power off to prevent severe discharge of the battery
	<p>ⓘ Note: This is an emergency cut off level to protect the battery from severe damage. You should not rely on this cut off level during normal operation, but manage your power consumption to a discharge level of 11.5V or above.</p> <p>This cut off only applies to power drawn from the battery by the leisure equipment that is controlled by the control panel power switch; it will not protect the battery from discharge by permanently connected equipment.</p>	
Leisure battery voltage high 	With control panel power on or off and leisure battery is selected (as active battery) and the voltage level rises above 15V	Message on screen and repeated beeps from the control panel. The power is automatically turned off. The beeping will not stop until the fault is cleared.
Vehicle battery warnings	If the vehicle battery is selected instead of the Leisure battery, then similar warnings to those described above are applied to the vehicle battery. The vehicle battery low warning level is 10.9V	
Engine running 	When the engine is started the system power will be turned off	Message on screen stating 'engine running'.
Step extended 	Step extended and engine started Step jammed or obstructed	Message on screen and warning buzzer
Mains lead (hook-up cable) still connected / plugged in 	When the engine is started and the mains cable is still plugged in and the charger is switched on	Message on screen and repeated beeps from the control panel. The beeping will not stop until the hook-up lead is removed.

User Settings & Bluetooth Pairing

The EC940 control panel has a number of user settings, which can be accessed by pressing the User Settings button. This screen also displays the software version number of the PSU, Control Panel and the communicator / tracking unit details, if a Sargent EC660 Communication Unit is fitted.

User Settings screen - Here you can set the key beeps, screen brightness, screen on time etc.

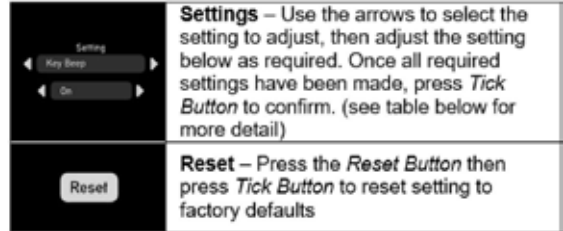

Section	Possible Settings	Description
Key Beep	On / Off	Turn the key beep sound on or off
LCD Brightness	10% to 100%	Adjust screen brightness
Backlight Time	30 seconds to 1 hour + Always On	Adjust time before screen backlight goes off
Water Alarms	On / Off	Turn the water alarms beep sound on or off
Lighting Mode	None / Lights / Lights & Dimmer	Sets lighting behaviour when control panel is switched on, None – Not used Lights – Normal lights come on. Dimmable lights are off. Lights & Dimmer – Normal lights come on. Dimmable lights come on at the last used dim level setting

8.7 System Technical Information

The following section provides further technical information relating to the electrical system. You can also access the supporting technical manual from www.sargentltd.co.uk

Residual Current Device & Miniature Circuit Breakers

The Residual Current Device (RCD) is basically provided to protect the user from lethal electric shock. The RCD will turn off (trip) if the current flowing in the live conductor does not fully return down the neutral conductor, i.e., some current is passing through a person down to earth or through a faulty appliance.

To ensure the RCD is working correctly, the test button should be operated each time the vehicle is connected to the mains supply (see section 2.3)

The Miniature Circuit Breakers (MCB's) operate in a similar way to traditional fuses and are provided to protect the wiring installation from overload or short circuit. If an overload occurs the MCB will switch off the supply. If this occurs you should investigate the cause of the fault before switching the MCB back on.

MCB	Rating	Output Wire Colour	Description
1	10 Amps	White	230V Sockets
2	16 Amps	White (Yellow for heater)	Extra 230V Sockets / Heating System
3	10 Amps	Black (Blue for Whale water heater)	Fridge / Charger / Auxiliary devices / Whale Water Heater

Generator Usage

Caution should be used before connecting a generator to your motorhome.

⚠ WARNING: Never start or stop the generator while electrical loads are connected and switched on. Start the engine, let it stabilise and then connect the electrical load. When stopping the generator, disconnect the electrical load and let engine stabilise before switching off.

Whilst some generators use electronic inverter technology, others use a more basic principle to generate the 230V supply. Preference should be to choose a generator which produces a consistent sinusoidal wave form with accurate voltage control.

The Reverse Polarity warning light on the PSU may illuminate when using a Generator. This is a normal side effect when using some types of generator. Instead of connecting the neutral conductor to earth, some generators centre-tap the earth connection making both neutral and live conductors 110V above earth. This 110V difference causes the neon polarity indicator to illuminate.

In most cases it is safe to use a generator, but please consult the generator handbook for further information.

Battery Charger PX300 (When fitted)

The system incorporates an intelligent three-stage battery charger.

During stage 1 the battery voltage is increased gradually while the current is limited to start the charging process and protect the battery. At stage 2 the voltage rises to 14.4V to deliver the bulk charge to the battery. When the battery is charged, the voltage is decreased at stage 3 to 13.6V to deliver a float charge to maintain

the battery in the fully charged state. The charger can be left switched on continuously as required.

The battery charger / power converter also provides power to the leisure equipment when the mains supply is connected. This module supplies DC to the leisure equipment up to a maximum of 25 Amps (300 Watts), therefore the available power is distributed between the leisure load and the battery, with the leisure load taking priority as per the following example:

Leisure load	Available power for battery charging
5A	20A
10A	15A
15A	10A
20A	5A

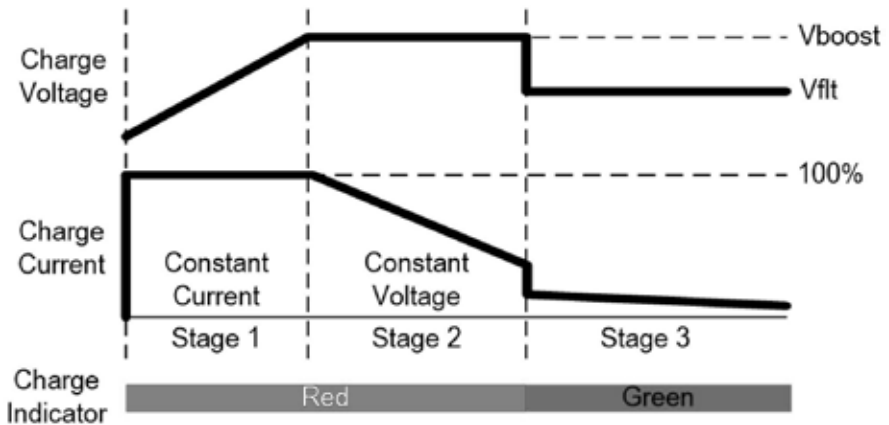

⚠ WARNING: Under heavy loads the Battery Charger case may become hot. ALWAYS ensure the ventilation slots have a clear flow of air. Do not place combustible materials against / adjacent to the charger.

Battery Charger PX310 (When fitted)

The PX310 multi-stage battery charger is designed for leisure vehicle applications, providing power for both battery charging and 12 volt appliances. The integrated LCD display shows battery charging status and allows setup

for different battery chemistries. A PSU mode allows the charger to be used without a battery fitted and the Silent mode avoids noise during overnight charging.

Battery display



The LCD display shows useful information about the battery charging status and also allows the charger settings to be configured.

Before using the charger, the correct battery type should be set from the LCD display using the following procedure:

1. After switching on charger press **OK** button for 3 seconds to enter Setup Mode, the battery type should then start to flash
2. Press **▶** button to change battery type, then press **OK** to confirm



Display	Description
	The current charging mode, which will advance from BULK > BOOST > FLOAT as the battery charges
	The currently selected battery chemistry, which can be Flooded, Gel, AGM or LiFePO4
	The battery charging Voltage and Current
	This symbol shows if the cooling fan is in Normal or Silent Mode

Fan Operation

The unit is fitted with an intelligent cooling fan, which can adjust its speed depending on the load and temperature.

In order to restrict noise (for example at night) the fan can be put into

Silent Mode. In this mode the fan will always be off but the charger output will be restricted to a maximum of 5amps.

1. During charging press the button for 3 secs to enter Silent Mode
2. Press the button again to exit Silent Mode

The charger will also exit the Silent Mode when:-

- The charger is turned off then on again
- 12 hours have passed

Power Supply Mode



After the charger is switched on, it will check if a battery is connected. If no battery is detected, the charger will enter PSU Mode and output a constant

13.6 volts. This enables the charger to be used as a power supply when no battery is fitted.

If a battery is detected it will enter the normal 3-stage charging cycle.

Wakeup Mode

If battery type LiFePO4 has been selected, then during startup the charger will briefly enter Wakeup Mode in order to wake a sleeping lithium battery.

This will help avoid the charger entering PSU Mode due to no battery being detected.

Error Modes

If there is a problem during charging, the display will show a warning message and disable the charger output.

For more detailed information on the PX310, its charging profiles and specifications, visit the link below or Scan the following QR code.



<https://sargent.zohodesk.eu/portal/en/kb/articles/px310-20amp-3-stage-battery-charger>

Leisure Battery

A) Type / Selection

For optimum performance and safety, it is essential that only a proprietary brand LEISURE battery is used and it is suggested to select a battery from the NCC Verified Battery Scheme with a typical capacity of 75 to 180 Ah (Ampere / hours). Depending on the prospective use of the vehicle the correct type should be selected (A, B or C). A normal car battery is NOT suitable. This battery should always be connected when the system is in use.

The PSU is configured to work with standard lead acid leisure batteries, and in most cases is also compatible with the latest range of Absorbed Glass Matt (AGM) batteries. The system is also suitable for Lithium batteries with built-in Battery Management Systems (BMS). Before fitting non-standard batteries please check that the charging profile as described above is suitable for the type of battery by referring to the battery documentation or battery manufacturer.

Some vehicle installations can cater for two leisure batteries connected in parallel. In these cases, it is recommended that two identical batteries are used.

The battery feed is fitted with an inline fuse between the battery and the electrical harness, and is usually located immediately outside the battery compartment or within 500mm of the battery. The maximum rating of this fuse is 20A per battery. If a single battery is fitted this fuse could be up to 40A, however if two batteries are fitted each battery should be fused at a maximum of 20A.

B) Installation & Removal

Always disconnect the 230V mains supply and turn the PSU green charger switch to the off position (button out) before removing or installing the battery.

When connecting the battery, ensure that the correct polarity is observed (black is negative [-] and red is positive [+]) and that the terminals are securely fastened. Crocodile clips must not be used.

Note: If a tracking solution is fitted with an active Thatcham subscription, it is advised to inform the tracking call centre before removing the battery, to avoid an unnecessary security call.

WARNING: Explosive gases may be present at the battery. Take care to prevent flames and sparks in the vicinity of the battery and do not smoke.

C) Operation / Servicing

Under normal circumstances it should not be necessary to remove the battery other than for routine inspection of the terminals and "topping up" of the battery fluid where applicable. Please see instructions supplied with the battery.

Note: Do not over discharge the battery. One of the most common causes of battery failure is when the battery is discharged below the recommended level of approximately 10V. Discharging a battery below this figure can cause permanent damage to one or more of the cells within the battery.

To prevent over discharge, the power control system incorporates a battery protect circuit that warns the users and then disconnects the batteries when they fall below set values.

If a warning is active a beep will be emitted by the control panel and information will be shown on the screen. To mute the warning, press the bell icon. These warnings will not be repeated unless the power switch is turned off and on again. This is to ensure the warning does not become a nuisance.

Battery	Voltage cut off	Action after cut off	Notes
Vehicle	10.9V	Battery selection is changed from Vehicle battery to Leisure battery. If the leisure battery is below 9V then a further warning will occur (see below).	This cut off level is designed to protect the vehicle battery from over discharge. The 10.9V level ensures there is sufficient power in the battery to run the vehicle electronics and start the vehicle. This cut off only applies to power drawn from the battery by the leisure equipment; it will not protect the battery if you leave vehicle circuits switched on, such as the road lights.

Battery	Voltage cut off	Action after cut off	Notes
Leisure	9V	Power is turned off	<p>This is an emergency cut off level to protect the battery from severe damage. You should not rely on this cut off level during normal operation, but manage your power consumption to a discharge level of about 11.5V.</p> <p>This cut off only applies to power drawn from the battery by the leisure equipment that is controlled by the control panel power switch; it will not protect the battery from discharge by permanently connected equipment.</p>

12 Volt DC Fuses

⚠ WARNING: When replacing fuses always replace a fuse with the correct value. NEVER replace with a higher value / rating as this could damage the wiring harness. If a replacement fuse 'blows' do not keep replacing the fuse as you could damage the wiring harness. Please investigate the fault and contact your dealer.

The following table shows the fuse allocation for the 13 fuses fitted to the PSU. Please note that fuses are dependant on PSU versions, so not all fuses may be present.

Fuse	Rating	Fuse Colour	Description
1	25 Amps	White	Charger / Spare*
2	7.5 Amps	Brown	Permanent 12V / Alarm / Fridge Electronics
3	10 Amps	Red	12V Sockets / TV Amplifier
4	10 Amps	Red	Extractor Fans
5	5 Amps	Tan	Appliances / Hob Ignition / Toilet / Whale Water Heater
6	10 Amps	Red	Water Pumps / Tank Heaters
7	10 Amps	Red	Lighting, Main Lights & Dim Channel 1
8	10 Amps	Red	Lighting, Entry Light & Dim Channel 2
9	10 Amps	Red	Alde Heating, Truma Heating, Whale Air Heater, Marker Lights, En-Route Sockets & Lights
10	10 Amps	Red	Auxiliary / Awning Light / Electric Step
11	10 Amps or 15 Amps or 20 Amps	Red Blue Yellow	Compressor Fridge Supply Under counter Fridge 12V Fridge freezer 12V
12	15 Amps	Blue	Towing 12V
13	15 Amps or 20 Amps	Blue Yellow	Under counter Fridge D+ Fridge freezer D+

*The PX310 Intelligent 300W Battery charger (When fitted)

Note: Fuses (2-13) have a Red LED below them which provides indication that the fuse has blown. The charger fuse has a green LED which indicates that the charger is working. Fuses 11 and 13 are 10A for compressor fridges, 15A for under counter fridges and 20A for fridge freezers.

The following table shows details of the fuse(s) located at the Leisure battery.

Fuse	Rating	Fuse Colour	Description
Battery 1	40 Amps	Orange	Fuse remotely located near battery
Battery 2	40 Amps	Orange	Fuse remotely located near battery 2 (where fitted)

8.8 Common Fault Table

Fault	Possible Cause	Proposed Fix
No 230-volt output from PSU	Connecting lead between the site and Leisure Vehicle not connected	Check and connect lead as per (Connecting to the mains 230v supply and safety checks C)
	RCD switched off	Reset RCD as per (Connecting to the mains 230v supply and safety checks D)
	RCD not operating correctly	Check supply polarity; if the RCD continues to fail contact your Dealer as there is probably an equipment or wiring fault.
	MCB switched off	Reset MCB by switching OFF (down position) then back ON (up position), if the MCB continues to fail contact your Dealer as there is probably an equipment or wiring fault.
	No or deficient supply from site	Contact site Warden for assistance.
	Another fault	Contact your Dealer.
Reverse Polarity light is illuminated on PSU	Mains Supply reversed?	The reverse polarity light is designed to illuminate when the Live and Neutral supply has been reversed / crossed over. If the light illuminates there is a problem with the site supply or the cable connecting the supply to your vehicle. The light is designed to work on UK electrical supplies (where the neutral conductor is connected to earth at the sub station). If you are using your vehicle outside the UK this light may illuminate when no fault exists. In these cases, consult the site warden for advice.
	Generator being used	'The Reverse Polarity warning light is on when using my Generator'. This is a normal side effect when using some types of generator. Instead of connecting the neutral conductor to earth, some generators centre-tap the earth connection making both neutral and live conductors 110V above earth. This 110V difference causes the neon polarity indicator to illuminate. In most cases it is still safe to use the generator, but please consult the generator handbook for further information.

Fault	Possible Cause	Proposed Fix
Control Panel Problems	Control Panel has no display	<p>Check batteries and fuses, turn PSU isolate switch and charger switch on and ensure mains supply is connected.</p> <p>Check control panel connecting lead at PSU and behind Control Panel.</p> <p>Contact your Dealer.</p>
	12V Power turns off	<p>Battery protect feature has operated to protect the Vehicle battery and/or the Leisure battery. See (Leisure battery C)</p> <p>Over voltage protection has been activated, the control panel will display a warning. A number of things can cause this but the most common is the solar panel, it is worth checking the regulator is connected correctly and operating within the correct parameters.</p> <p>Engine has been started; all equipment has been disconnected to meet EMC requirements. See (Operation while driving)</p>
	Control Panel locked / erratic function	<p>Observe control panel handling instructions.</p> <p>Control panel software may have crashed. Reboot control panel by turning off the PSU isolate switch. Wait 30 seconds then turn the switch back on. Check with your dealer that your system has the latest software installed, as an update may be available.</p>
No 12-volt output from PSU	No 230V supply	Check all above.
	Charger not switched on	Turn charger switch on, switch will illuminate.
	Battery not connected and / or charged	Install charged battery.
	Power button on control panel not switched on	Turn power on at control panel.
	Battery flat / Battery fuse blown	Recharge battery, check fuses, check charging voltage is present at battery.
	Fuse blown	Check all fuses are intact and the correct value fuse is installed as per fuse table.
	Equipment switched off / unplugged	Check equipment is switched on and connected to the 12V supply.
	Another fault	Contact your Dealer.
Pump not working	Fuse blown	Replace fuse with correct value as per fuse table.
	Pump turned off	Turn pump on by pressing the pump button at the control panel.
Lights not working	Fuse/s blown	Replace fuse with correct value as per fuse table.
	Lights turned off	Turn Lights on by pressing the lights button, use dimmer at the control panel.

Technical Support

If you require technical support on Sargent products then please visit the Support Customer Support site at <https://sargent.zohodesk.eu/portal/en/home> In the Knowledge Base you can view product documentation and search frequently asked questions and in the Ticket section you can raise a ticket to request help from the support team.

Updates

From time to time there may be updates to the system firmware; these updates will be done at service intervals by your dealership.

8.9 Technical Data & Approvals

Equipment – EC403PSU, EC454PSU, EC456PSU, EC940, EC660 & PX300

Outline Specification		
INPUT 230V	230 Volts / 0 to 16 Amps	+ / - 10%
OUTPUT 230V	RCD protected, 2 x MCB outputs of 10A & 1 x MCB output of 16A Separate switched channels for heating system and charger	
INPUT 12V	2 x 20A battery inputs via 2 x 4-way connectors	
SOLAR INPUT	1 X Dedicated solar panel input capable of supporting 10A of solar power input (typically 180 to 200W) via a 2-way connector	Check the solar panel rating plate to ensure the maximum current is <= 10A
OUTPUT 12V	25A total output via multiple switched channels protected by 13 fused outputs	
Integrated CHARGER	Input 220-240 Volts AC +/- 10%, Frequency 50 Hz +/- 6%, Current 3A max. DC Output 13.6 to 14.4 Volts nominal, Current 25 Amps max (300 Watts).	
Signal INPUT	4 x Fresh water level, 4 x Waste water level, 1 x Engine running, plus multiple vehicle connections, sensor inputs for temperature & humidity	Fresh water negative sensed Waste water negative sensed
Data IN / OUT	CANBUS Data communication and power to Control Panel via 6-way connector CI-Bus Data communication to CI-Bus enabled devices via RJ11/12 connector	
IP rating	IP31	
Operating temperature	Ambient 0 to 35° Celsius Charger case temperature with full load 65° C Max	Automatic shutdown and restart if overheated / overloaded

Dimensions		
EC403PSU, EC454PSU, or EC456PSU	Overall size (HxWxD) 180 x 305 x 135mm Clearances 75mm above, 50mm left & right	Weight 3.8 Kg
EC940 Control Panel	Overall size (HxWxD) 94 x 94 x 26mm Cut-out size (HxW) 86 x 86mm	Fixing via hidden spring clips Weight 135g
EC850 Sensor	Overall size (HxWxD) 20 x 35 x 38mm	Weight 10g

8.10 Approvals

System: BSEN 1648-1, BSEN1648-2 compliant, BS7671: 2018 compliant

Residual Current Device: RCD 40A 30mA trip to BS EN 61008

Miniature Circuit Breakers: MCB's type C 6000A breaking capacity to BSEN 60898

Power supply unit: Automotive Electro Magnetic Compatibility (EMC) to ECE Reg10.06, Type approval number E11 10 R 06 12228

Touchscreen control panel: Automotive Electro Magnetic Compatibility (EMC) to ECE Reg10.06, Type approval number E11 10 R 06 12232

Integrated Charger: BS EN 60335-1/2.29, 2006/95EC, IEC61000-3.2/3:1995, 1.

Low Voltage Directive: 2006/95EC TUV-014900-A1, EN55022, Class B, EN55024/ Level 2

Declaration of Conformity

Equipment: Leisure Power Control System Model name: EC403PSU, EC454PSU, EC456PSU, EC940, EC660 & PX300

I hereby declare that the equipment named above has been designed to comply with the relevant sections of the above referenced approvals. The unit complies with all essential requirements of the Directives.

Signed	Name	Position	Manufacturer
	I L Sargent	Technical Director	Sargent Electrical Services Ltd Unit 35, Tokenspire Business Park Woodmansey, Beverley East Yorkshire, United Kingdom
Date:			

Whilst every effort has been made to ensure the accuracy and completeness of this document, no guarantee is given against errors or omissions. This document may be updated / improved over time therefore please check with your dealer / supplier for update information or visit www.sargentltd.co.uk

9. Fitted equipment

9.1 Whale Heat Air GE Space Heater	83
9.2 Whale Rapid Heat Water Heater (Trekker S, Trekker X)	84
9.3 Whale Expanse Water Heater	85
9.4 CAN F05010 Oven	87
9.5 Dometic Hob and Bowl	92
9.6 Thetford toilet	96
9.7 Windows	96
9.8 Furniture doors	79
9.9 Cab Seat Swivel	99
9.10 Omnistep slide-out step	99
9.11 Thule 5200 Awning	100
9.12 TV aerial connectivity	101
9.13 Care of laminate tops, tables, furniture and doors	101
9.14 Furniture doors	101
9.15 Table storage	101
9.16 Shower	101
9.17 Colour reference	102

Note: The instructions covering fitted equipment to your motorhome were correct at the time of going to print, and where possible, hyperlinks and QR codes have been used, which provide links to online versions of user instructions. Owners handbooks are updated annually and we take great care to try and ensure their accuracy. However, the Swift Group Limited cannot accept responsibility for any changes that may be made in specification or operating instructions to the equipment described in this section after the time of going to press.

Every care is taken to ensure that the information provided in this handbook is correct and easy to understand.

Separate manufacturers' leaflets on many of the components are also included in the Owner's Pack provided with this motorhome and we recommend that you compare the instructions provided via the handbook with the component manufacturers literature, to ensure the information provided is as accurate as possible.

If you are in any doubt as to how to operate the equipment in your motorhome, please contact the component manufacturer's service department on the telephone number shown on their component leaflet. If you remain in any doubt, please contact your supplying dealer.

Note: In the interest of safety, replacement parts for an appliance shall conform to the appliance manufacturer's specifications and should be fitted by them or their authorised agents.

Equipment Specification

For details on type of equipment fitted in your vehicle, please refer to the Sales Brochure or Dealer.

 **WARNING:** To maximise the use and life of all fitted equipment in your vehicle it is essential that any accompanying manufacturers' literature is read fully. All recommended maintenance and preparation procedures should be followed. The information provided in this handbook is only intended as a guide. If in any doubt consult your manufacturer appointed dealer, particularly before attempting to install EXTRA EQUIPMENT.

9.1 Whale Heat Air GE Space Heater



The Whale Heat Air is a dual fuel blown air space heater fitted beneath the motorhome. The controller mounted above the entrance door allows the selection of 230v mains electric / bottled gas energy sources to heat your motorhome, when they are available, along with selection of target room temperature. A 12v fan within the heater distributes heated air through the motorhome via furniture mounted outlets.

To make use of 230v mains electric as an energy source, locate the 'HEATING SYSTEM' illuminated button on the EC940 Power Supply Unit in the rear bed, and ensure it is ON (illuminated).

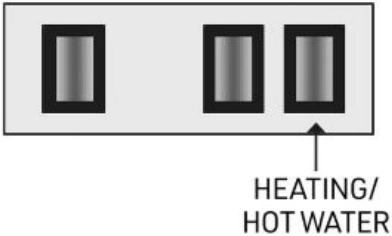

The blown air outlets will typically feature one closable outlet, and several fixed / open outlets. Do not block the blown air outlets while using the heater. Similarly, there is a recirculation air intake in the rear bed – this is fitted with a cowl to prevent the ingress of small items, please ensure when packing luggage that the intake is not suffocated.



The space heater must not (and cannot) be used while the motorhome is en-route. Isolate the gas supply before starting your journey.

For detailed instructions of the space heater operation, see the paper copy supplied with your motorhome or the electronic version located at:

<https://whale.navico.com/downloads/#/4/14/73>



9.2 Whale Rapid Heat Water Heater (Trekker S, Trekker X)

The Whale Rapid Heat is a dual fuel 8 litre storage water heater, located in a cupboard at the rear of your Trekker. Before using the water heater, ensure the fresh water system is primed, see section 7.2. To prime the water system, the valve located close to the water heater must be in the CLOSED position (See below). Open this valve when draining the fresh water system

Whale water heater drain valve

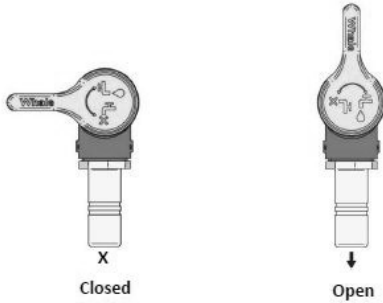

The control for the water heater is located in the cupboard near to the appliance.



The controller allows the selection of 230v mains electric or bottle gas energy sources (when available).

For Gas Operation

Operate the left-hand switch to the on (flame) position. There will be a pre-purge pause of approx. 5 seconds to allow any un-burnt gas to leave the flue and will extinguish when the water is up to temperature.

A green LED will light upon successful flame ignition. If there is air in the gas supply line, it may take a few attempts for the gas to ignite. If the ignition is not satisfactory, the Red diagnostic LED will flash.



For Electric Operation

First, locate the fused spur located close to the Power Supply Unit (PSU), and turn on the water heater fused spur (see phot above). The Water Heater is equipped with twin 600W / 1200 W. immersion heater elements offering operation at 600W or 1200W. Operate the right-hand rocker switch to the top position (~) to turn on one electric element. To turn on both electric elements, operate the right-hand rocker switch to the bottom position.

Note: The electric elements will still operate if the appliance is in gas ignition lock-out.

Gas and Electric Operation

For faster heating, the appliance can be operated with both gas and electric.

Switching Appliance Off

Operate the left-hand gas switch to the top Off position (O) and the right-hand electric rocker switch to the centre position (O). If the Water Heater is not going to be used for some time, isolate the gas supply and drain water if there is a risk of freezing.

For further details see the information provided as a paper copy with your motorhome, or follow the link below:

Quick reference and detailed instructions are available for the water heater, please read these before using the water heater. They are available at:

<https://whale.navico.com/downloads/#/4/16/79>



If you are unable to view the documents on line, please contact the supplier, your dealer or Swift for an electronic or paper copy.

9.3 Whale Expanse Water Heater

The Whale Expanse is a dual fuel 8 litre storage water heater, fitted below or above floor depending on which model of Trekker you have.



The controller mounted above the entrance door allows the selection of 230v mains electric or bottled gas energy sources (when available), along with selection of target hot water temperature.

Before using the water heater, ensure the fresh water system within the motorhome is primed - see section 7.3. Use of the water heater without water in the system may cause damage to the appliance. To prime the water system, the Yellow handled drain valve on top of the water heater (visible in the rear bed area) must be in the CLOSED position. Open this valve when draining the fresh water system.

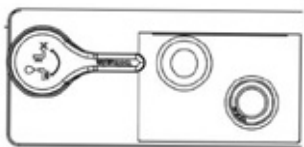

To make use of the 230v / mains electric energy source, locate the fused spur mounted on the side of the Power Supply enclosure, and ensure it is ON



The water heater must not (and cannot) be used (heated) whilst en-route. Isolate the gas supply before starting your journey.

For detailed instructions of the water heater operation, see the paper copy supplied with your motorhome or the electronic version located at: www.whalevanlife.com



<https://bit.ly/3ESAiHg>

9.3 Dometic Compressor Fridge



RC10.4T



NRX50

The RC10.4T or NRX50 compressor fridge (model dependent) uses a 12v DC supply for all control and cooling of the refrigerator.

When driving, the fridge operates using the on board leisure battery and the vehicle alternator as a power supply. Ensure the System Shutdown button on the Power Supply Unit is in/ON while driving.

When parked and on mains hook up, the fridge operates using the on board leisure battery and on board battery charger as a power supply. Ensure the battery charger is ON, using the illuminated button on the Power Supply Unit.

When parked without mains hook up, the fridge uses the on board leisure battery and fitted solar panel as a power supply. Monitor battery use regularly using the EC940 Control Panel (see page 67) above the entrance door, and return to a mains hook up or driving if the leisure battery becomes depleted.

For full instructions and safety advice relating to this refrigerator, see the paper copy instructions supplied with the motorhome, and/or the electronic versions available at the following location:

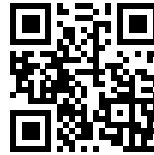

<https://bit.ly/3UhDyBL>

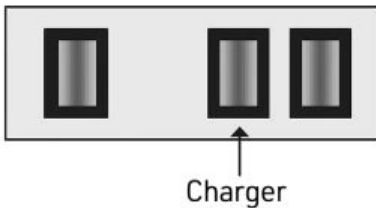

9.4 CAN F05010 Oven



Before using the appliance, please read instructions carefully.

⚠ CAUTION: During operation and for a few minutes after use, some parts of the equipment reach very high temperatures. Do not come in contact with these parts without adequate personal protective equipment. Burn hazard!

⚠ CAUTION: Always use the supplied grills/grill drip trays

⚠ CAUTION: Before using the device in GRILL mode, it is mandatory to open the door completely and remove the protective deflector of the control panel. The door and the deflector shall remain open throughout the entire operation.

- Do not cook food in direct contact with the flame.
- Never cover the appliance or parts of it with aluminium sheets or similar.
- Do not heat tight tin boxes or pressure containers on the equipment, the overpressure generated by the heat may cause them to explode and cause serious injury.
- Make sure that the cooking pans are of the suitable type for this device and place them correctly on the grill/drip tray, ensuring they are not wobbling. The Manufacturer is not responsible and does not recognise the right to warranty if this requirement is disregarded.
- Always supervise the appliance while functioning.

- Turn off the burner after each use.
- Do not place or hold liquids or flammable materials or objects easily ignited on the cooker or in the immediate vicinity.
- Do not hit the front panel controls with hot pans, grills and drip trays
- Do not put the burner into operation without pots and/or empty pans.
- Do not use cooking appliances when the vehicle is on and/or on the move.
- Do not cook food directly on the support grills/drip trays that support baking pans.

⚠ CAUTION: In case of fire of cooking grease or hot oil do not extinguish the flames with water but with a damp cloth or similar object and notify the fire fighters promptly.

⚠ CAUTION: During use, gas firing equipment generates combustion products which must be disposed of outside the installation spaces by suitable ventilation systems.

📌 Note: Before proceeding to the first use, it is necessary to thoroughly clean the equipment and its components as indicated in the "Cleaning" section.

During the first use, the equipment may generate smoke and unpleasant odours.

Don't be alarmed, as this is due to combustion of the grease used for manufacturing the appliance in the factory.

All burners of this equipment are equipped with safety thermocouple.

The thermocouple is equipped with a heat-sensitive device: as long as it is heated by the flame of the active burner, it allows gas to be released from the nozzle; if the flame accidentally extinguishes (e.g. liquid overflows from the pan), the thermocouple will cool in a few seconds and this blocks the gas exiting the nozzle.

CONTROL ZONE

The device front side (upper part of the equipment accessible from the front side) incorporates an electronic flame ignition button (oven and grill) and a knob connected to a gas valve with thermostat for regulating the temperature in the oven/grill.

⚠ CAUTION: The control knob on the gas valve, when rotated counter clockwise activates and controls the oven function, while when rotated clockwise all the way, it activates the grill function. The burners can't work simultaneously.

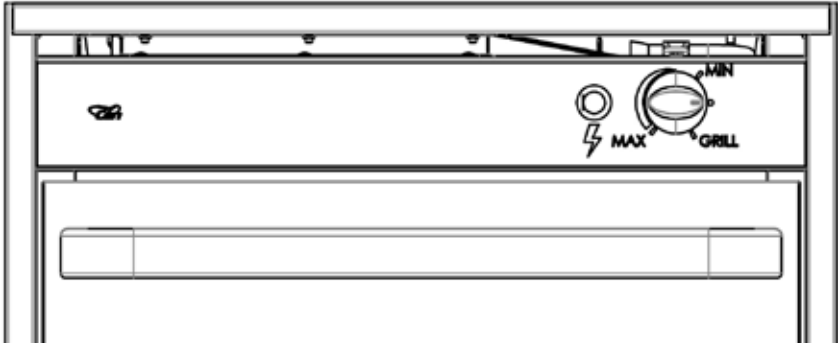

⚠ CAUTION: Before use, check that the external components of the burners are firmly connected to their supports.

⚠ CAUTION: The ignition of the burners must always occur with the door of the oven/grill compartment open. Keep it open for a few minutes after ignition to allow the proper air and exhaust gas circulation.

IGNITION AND USE OF THE DEVICE IN OVEN MODE

The ignition of the oven burner must always occur with the door of the oven cavity open, according to the following operating procedure:

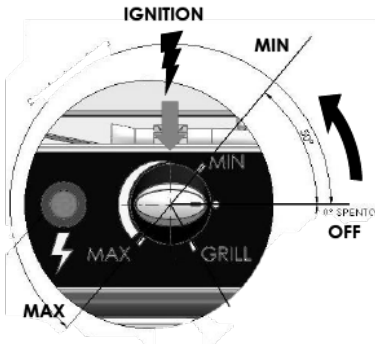

OVEN BURNER	
Step	Action
1	Press the control knob and rotate it counter clockwise (until you reach the IGNITION point - 90° ANGLE from OFF).
2	After 3 seconds, operate the electronic ignition device by fully pressing the power button next to the control knob.
3	After switching on, keep the control knob firmly pressed for another 5 seconds (always keeping it at the MIN mark) and then release it, adjusting the temperature desired. The device can reach a maximum temperature of 200° C
<p>① Note: this release delay is used to heat the safety thermocouple.</p>	

If upon releasing of the knob, the burner won't stay lit, it means the thermocouple was not sufficiently pre-heated. To work around this problem, repeat the steps described in the table, holding the knob longer after turning on the burner.

⚠ CAUTION: Ignition should be carried out without any pan or other object placed inside the oven.

When ignition is complete, it is possible to close the furnace door to allow preheating of the cavity: although the furnace heating takes place quickly, **it is advisable to wait a preheating period of about 15 minutes**, after setting the desired temperature level as indicated in the next paragraph.

FLAME REGULATION

To set the desired cooking temperature, operate the control knob counter clockwise and more precisely **place the indicator placed on the knob in the control range between the minimum MIN and maximum MAX mark**. The oven is limited to a maximum temperature of 200° C.

The flame delivery is regulated by the thermostat associated with the control knob: it is possible that during operation there is a change in the length of the flame due to the automatic modulation of the gas supply carried out by the thermostat.

⚠ CAUTION: If the flame is unstable and uneven, check the correct positioning of the external components of the burners and make sure there are no obstructions.

FOOD COOKING OR HEATING

⚠ WARNING: Do not forget the device turned on with the burners running without pans or with empty pans

⚠ WARNING: Never cook food directly in contact with the walls or the bottom of the oven cavity. Fire hazard.

⚠ WARNING: Only use pots, pans and accessories expressly designed for this use, made from materials resistant to high temperatures and suitable for contact with food.

Place the cooking trays and pans directly on the internal grills/drip tray taking care to leave them apart from the inner walls of the oven cavity. The height of grills and drip tray is adjustable according to the type of dish and cooking method.

① Note: For better efficiency and rational use of energy during the operation of the device in oven mode, always cook with the door of the oven closed.

TURNING OFF THE BURNER

Once you have finished cooking, turn off the equipment by returning the control knob's notch to OFF position, next to the stop symbol (full ball). Once turned off, remove the dish from the oven cavity taking care to wear the appropriate burn protection equipment.

Wait for the device to cool down completely before cleaning.

SWITCHING ON/USE OF THE DEVICE IN GRILL MODE

⚠ CAUTION: When using the oven in GRILL cooking mode, the oven door must always remain fully open. Always pull out the deflector for better protection against heat of the control panel and control units.

Before turning on the device in GRILL mode, when the appliance is cold, open the door completely and remove the deflector at the top of the cavity. Turn on the grill burner according to the following operating procedure:

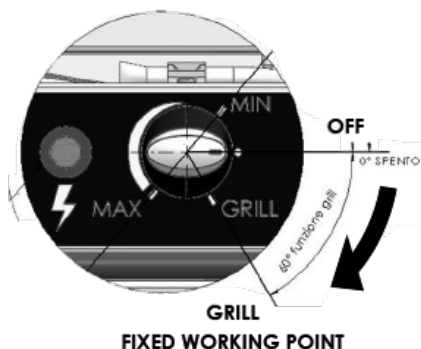

GRILL BURNER	
Step	Action
1	Press the control knob and turn it clockwise all the way to the GRILL notch.
2	After 3 seconds, operate the electronic ignition device by fully pressing the power button next to the control knob
3	After switching on, keep the control knob firmly pressed for another 5 to 10 seconds in the same position. <div style="background-color: #cccccc; padding: 5px; border: 1px solid black;"> Note: this release delay is used to heat the safety thermocouple. </div>

TURNING OFF THE BURNER

Once you have finished cooking, turn off the equipment by returning the control knob's notch to OFF position, next to the stop symbol (full ball). Once switched off, remove the food from the cavity of the device taking care to wear the appropriate burn protection equipment. Wait for the device to cool down completely before cleaning.

OPERATION ANOMALIES

The following situations are considered to be operating malfunctions and assistance is required if:

- The flame of the burner is yellow.
- You notice the formation of soot on the interior accessories or on the bottom of the device.
- Burners do not ignite properly.
- The burners won't stay lit.
- The burners are switched off when the kitchen doors are moving.
- The control knob is difficult to operate.

If the appliance is not working, contact the authorised local dealer.

PROCEDURES TO FOLLOW IN THE EVENT OF MALFUNCTIONING

Before contacting your nearest Support Centre, carry out the following operations: verify that the hob is properly connected to the installation; check that the hob is properly powered; identify the data of the appliance from the CE label bearing the product serial number; find the date and a suitable document (invoice or receipt) certifying the purchase of the equipment.

⚠ CAUTION: While you wait for the problem to be resolved, you should not use the appliance and isolate it from all systems to which it was previously connected.

Do not attempt to repair or tamper with the appliance.

CAN S.r.l. ensures optimal collaboration and support if technical or other type of problems should arise, on any of its products.

For any information or assistance request contact your nearest retailer or get in touch with CAN S.r.l.

MAINTENANCE AND CLEANING

No specific maintenance procedures are required for the equipment except for proper and regular cleaning.

No specific maintenance procedures are required for the equipment except for proper and regular cleaning.

⚠ CAUTION: Before proceeding with cleaning, make sure that the burner is turned off.

Always wait until the appliance cools down completely.

- Regularly clean the equipment, its components and accessories to ensure optimal operation over time
- Disconnect the power supply (if any) and close the gas supply valves before each cleaning operation or when prolonged inactivity is planned. Ensure all the knobs are always in the "off" position at the end of use.
- Do not use steam appliances or direct water jets to clean the hob.

⚠ CAUTION: Do not use hydrochloric acid (commercial muriatic and/or chloride-containing detergents) on stainless steel surfaces.

⚠ CAUTION: Do not use abrasive powder detergents that could spoil the aesthetic appearance of the surface finish.

If some particular acidic substances (e.g. vinegar, lemon juice, etc....) remain for long periods on the appliance, they could damage the surface creating unsightly stains which would not however prejudice functionality of the appliance.

Types of cleaning	Description
STAINLESS STEEL SURFACE	Use a soft cloth slightly soaked in neutral specific detergent or hot vinegar. Rinse with warm water and dry. Note: for how to use the cleaning products follow the instructions of their manufacturer).
GLASS SURFACES	Wash with glass specific detergent and rinse to make sure you have removed any residue of detergent. Always use soft cloths to avoid scratching the glass surface.
KNOBS	Use a soft cloth slightly soaked in neutral detergent. Ensure no detergent infiltrates under the knobs. Do not remove the knobs from the pin on which they are mounted. Note: for how to use the cleaning products follow the instructions of their manufacturer).

CAUTION: During and after cleaning, check that no hole or slot inside or outside the equipment presents impurities and/or obstructions.

WARNING: Abusive or incorrect disposal of the product involves the application of the penalties provided for by current legislation.

Only for products with steel or chrome-plated iron grills: the (progressive) burnishing of the grids is a phenomenon due to the normal use of the equipment and does not affect its performance.

After cleaning make sure that you have correctly reassembled the grills and any accessories removed, taking care not to reverse their positions. The grills must always be stable and their inlets into the equipment must be unobstructed.

PROLONGED PERIODS OF INACTIVITY

If you plan not to use the equipment for a long period of time (more than 2-3 weeks) proceed as follows:

- carry out a thorough cleaning of the equipment;
- safely disconnect or cut off the power and gas supply.

DISPOSAL

The symbol of the crossed-out box indicates that the product must be sent to the appropriate recycling centres. Do not dispose of the equipment bearing this symbol together with ordinary household waste.

Follow the regulations in force in your country. Make the equipment intended for disposal unusable by removing the power cables.

WARRANTY

The terms and conditions of warranty provided by law shall apply. If the product is defective, please contact your nearest Authorized Service Centre or your dealer. For the repair of the equipment it is necessary to send the following documentation: copy

Full / most recent instructions including spare parts information, available at the following location



<https://airxcel.eu/rv-cooking-appliances/cookers-and-oven/fo5010/>

9.5 Dometic Hob and Bowl

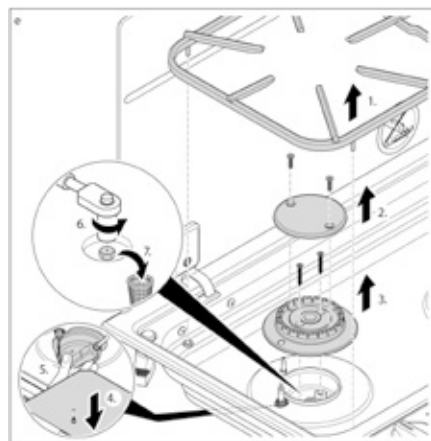
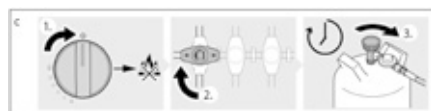
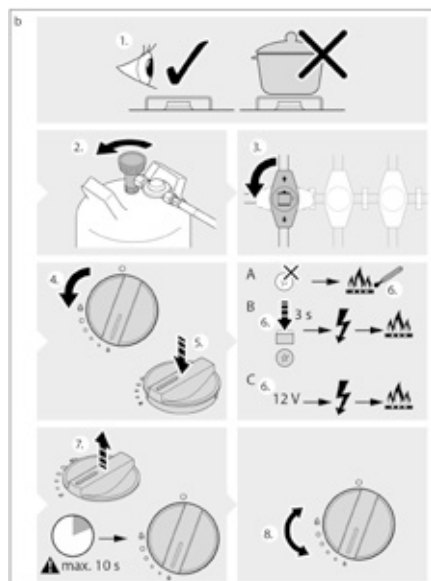
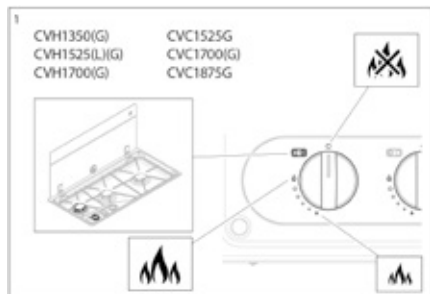
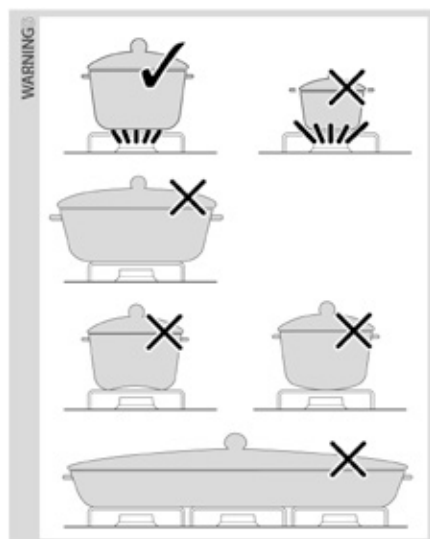
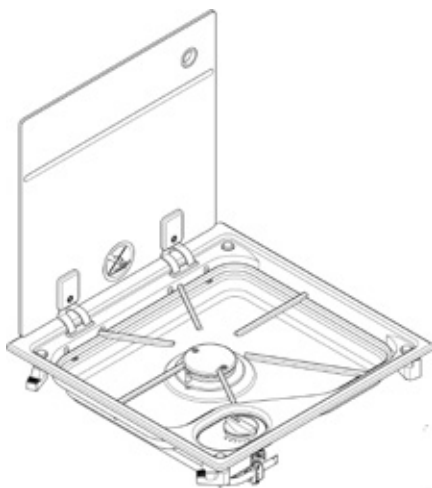



General safety

⚠ WARNING: Failure to obey these warnings could result in death or serious injury.

Explosion hazard

- This device may only be repaired by qualified personnel. Inadequate repairs may cause serious hazards.
- This device must be installed in accordance with any national regulations in force in the country of use.
- This device must only be used in a well ventilated space.
- Read the instructions before installing or using this device.
- Do not modify the device.
- Do not remove or replace any components of this device.
- The gas hose has to be changed if required by the national regulations.

Fire hazard

- Do not leave this device unattended when hot or in use.
- Children must be supervised to ensure that they do not play with the device.
- Keep a suitable fire extinguisher ready.
- Ensure that the fire extinguisher is checked by skilled personnel in regular intervals.

Burn hazard

- Keep hands, face and hair away from burners.
- Do not wear loose clothing or allow long hair to hang freely while lighting or using this device.

- Keep children and pets safely away.
- Carefully monitor all activity around this device to avoid burns or other injuries.

CAUTION: Failure to obey these cautions could result in minor or moderate injury.

Injury hazard

- If the device has a glass lid, in case of glass lid breakage:
 - Shut off immediately all burners and any electrical heating element and isolate the device from the power supply.
 - Do not touch the device surface.
 - Do not use the device.

⚠ WARNING: Damage hazard

- If the device has a glass lid:
 - Close the glass lid before beginning a journey.
 - Turn off all the burners before closing the glass lid.

Safety precautions when handling liquid gas

⚠ WARNING: Failure to obey these warnings could result in death or serious injury.

Explosion hazard

- After use always disconnect the liquid gas cylinder. Store liquid gas cylinders away from heating or cooking devices and other light or heat sources in a well-ventilated area out of the reach of children.
- Never store liquid gas cylinders in unventilated areas or below ground level (funnel-shaped holes in the ground).
- Never store liquid gas cylinders in buildings such as garages.
- Any indoor storage must comply with national regulations.
- Do not store liquid gas cylinders on their side.
- Keep liquid gas cylinders away from direct sunlight. The temperature should not exceed 50 °C.

Operating the device safely

⚠ WARNING: Failure to obey these instructions will cause death or serious injury.

Hazard of carbon monoxide poisoning

- The process of burning liquid gas produces carbon monoxide which accumulates inside

enclosed areas. Only use this device with sufficient ventilation.

Suffocation hazard

- Operating this device in an unventilated area will reduce the amount of oxygen in this area.
- Do not use the device as a space heater.
- The use of a gas cooking appliance results in the production of heat, moisture and products of combustion in the room in which it is installed.
 - Ensure that the kitchen is well ventilated especially when the device is in use.
 - Keep natural ventilation holes open or install a mechanical ventilation device (e.g. a mechanical extractor hood).
- Prolonged intensive use of the device may call for additional ventilation, for example opening of a window, or more effective ventilation, for example increasing the level of mechanical ventilation where present.

⚠ WARNING: Failure to obey these warnings could result in death or serious injury.

Explosion hazard

- Do not use this device if it is leaking, damaged or does not operate properly.
- Never use the device in the following situations:
 - At petrol stations
 - On ferry boats
 - While transporting the caravan or mobile home with a transport vehicle or tow truck
- In case of fire shut off the gas supply.
- Do not place chemicals, flammable materials or spray aerosols near this device.
- Never use a naked flame to check for gas leaks.
- If you smell gas:
 - Do not attempt to light this device.
 - Extinguish any naked flames.
 - Turn off the gas supply.
 - Disconnect the device from the gas supply.
 - Have the gas system checked by a specialist.
- Only attach or detach the gas container outdoors away from a naked flame, pilot light or other source of ignition and only when this device is cool to touch.
- Before using the gas container, check that the

seal between this device and the gas container is in place and in good condition.

- If the seal is damaged or worn, do not use this device.
- Turn off the gas supply at the gas container after use.

Fire Hazard

- This device must be kept away from flammable materials during use.
- Do not place any objects other than cookware on or against this device.
- Never place this device near flammable materials (paper, dry leaves, textiles).
- Keep flammable objects away from the burner.
- Position cookware handles as follows:
 - Never allow cookware handles to extend beyond the edge of the device.
 - Turn cookware handles inward, but not extending over other burners.
- Do not excessively heat grease or oil.
- Only use dry pot holders to handle hot cookware.
- Turn off the device before removing the cookware.
- Only operate this device when an adult can attend to it.

Burn hazard

- Accessible parts may be very hot. Keep young children away.

CAUTION: Failure to obey these cautions could result in minor or moderate injury.

Burn hazard

- Use protective gloves when handling hot components.
- Leave this device to cool down properly before you touch it with bare hands.
- If you ignite a burner manually:
 - Use long matches or a suitable lighter.
 - Remove your hand quickly as soon as the burner ignites.
- The use of alcohol or prescription or non-prescription drugs may

impair your ability to properly assemble or safely operate this device.

Using the device

CAUTION: Burn hazard

- Do not touch the hot parts of the device during and after use. Leave the device to cool down properly.
- Do not close the lid before the device has cooled down properly.
- For CVC devices only:
 - If the device has glass lids and you leave the glass lid of the sink closed while cooking, keep a minimum distance of 10 mm between the cookware and the glass lid of the sink.
 - Do not use the sink during cooking. Let the device cool down properly before using the sink.
 - Remove any plastic accessories from the sink before cooking.

CAUTION: Do not shut the lid when a burner is alight.

Switching on



⚠ WARNING: Hazard of carbon monoxide poisoning

- Before switching on the device, ensure that the area is sufficiently ventilated.
- During use, there must be opened air vents with a cross-section of at least 150 cm² in the installation room.
- These vents can be closed when the device is not in use.

⚠ WARNING: Explosion hazard/Fire hazard

Only use gas of the allowed gas category.
Do not use any other fuels.

1. Choose suitable cookware for the selected burners according to the following table:

Burner (fig. a , page 10)	Cookware diameter	
S	10 – 16 cm	
M	10 – 18 cm	
L	16 – 22 cm	

2. Switch the cooktop on as shown (fig.b)
Depending on the model, the burners are ignited differently:

- Manual ignition: (fig.b)
- Piezo ignition: (fig.b)
- Electrical ignition: (fig.b)

Switching off

- Switch the cooktop off as shown (fig.c).

Replacing the gas container

⚠ WARNING: Explosion hazard

- Only replace the gas container in places with good ventilation.
- Ensure that there is no source of ignition nearby.
- Only change the gas container when the device is not in use and the gas supply to the device is switched off.

1. Switch the device off by turning the knob to the zero setting.
2. Close the valve on the gas container.
3. Replace the gas cylinder according to the instructions from the gas fitting manufacturer.

Cleaning and maintenance

CAUTION: Burn hazard

Leave the device to cool down properly before cleaning, checking or maintaining the device.

Cleaning the device

1. Remove the pan support (fig.c).
2. Clean the device with a soft, damp cloth (fig.c)

Find additional care instructions for stainless steel and glass surfaces online on



<https://documents.dometic.com/>

Annual safety check

The assembly and installation of the gas connection must be performed by a qualified person who has demonstrated skill and knowledge related to the construction, installation and operation of gas appliances and has received safety training to identify and avoid the hazards involved.

- For safety reasons, have the device checked by a qualified person every year for proper function. Any defects must be repaired.

Replacing the nozzles

The assembly and installation of the gas connection must be performed by a qualified person who has demonstrated skill and knowledge related to the construction, installation and operation of gas appliances and has received safety training to identify and avoid the hazards involved.

- Let a qualified person replace the nozzles as shown (fig.e - fig.f).

9.6 Thetford toilet

Cassette C223S

Your motorhome is fitted with a Thetford C223S toilet, which is plumbed directly into the motorhome water system, and does not have its own flush tank. Using the C223 model number, please read the user instructions for the toilet, which are available from the following location:

<https://www.thetford-europe.com/gb/welcome-thetford-support/c220-series-cassette-toilet>



If you are unable to view the documents on line, please contact the supplier, your dealer or Swift for an electronic or paper copy.

9.7 Windows

When the vehicle is in motion all windows must be closed.

The windows are equipped with handles with red buttons. Always push the button before turning the handle, when opening or closing the window.

To open, push the red button and turn the handles towards the centre of the window on all the catches, swivel the window pane open to the desired position and then tighten the knobs on both stays. To close, reverse the operation.

All opening windows have two catch positions. The first position with the handle in the groove of the keep, is for ventilation. The second is with the handle on the inner part of the keep and seals the window fully closed. When ventilating or closing the window ensure all handles are in the correct position or deformation or bending of the window can occur.

Operating instructions for blinds



To operate the Blind

The blind is housed at the bottom of the cassette and flynet at the top. The metal bar can be pulled up or down as required.

CAUTION: Never leave the blinds fully closed in direct sunlight, even for a short period of time or heat will accumulate between the window and the blind, resulting in a damaged window.

Roof lights

When opening the roof lights, care must be taken to release the locking mechanism as the unit is raised.

Roof lights must be fully closed when driving. Roof lights provide essential fixed levels of ventilation.

Mini and Micro Heki rooflight (when fitted)



To open depress the button (Fig. A).



Pull the bar down and forwards (Fig. B).

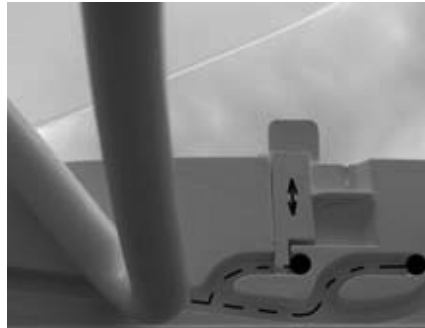

By pushing the bar in to the marked rest positions (Fig. C).

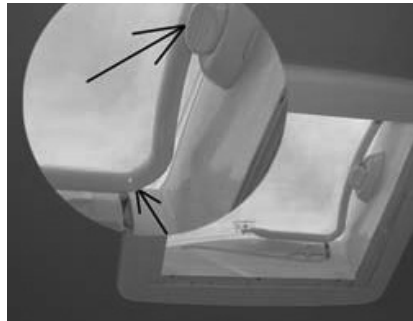

Two extra opening angles apart from the one in which the dome is fully opened can be chosen. The intermediate position can be fixed with a slide marked with the arrows. Care should be taken to ensure the dome is closed and locked for transit with the bar located behind the locking button (Fig. D).

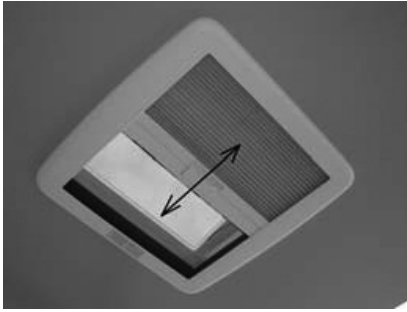

The blind flynet operate together and engage via the clips in the bar, then slide to gain the desired blackout or ventilation (**Fig. E**).

Midi Heki

Opening the Dome

Intermediate position for the dome

By pushing the bar into the marked rest position, two extra opening angles, apart from the one in which the dome is fully opened, can be chosen.

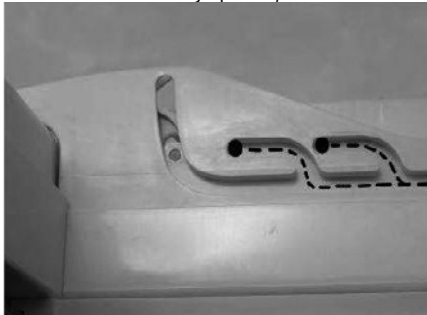

Closing the Dome (drive and rest position)

Push the bar with both hands on the right and the left side in such a way that the hook bolt

3. The dome on the left and the right side and the bar lies on the push button
4. Check if the dome is locked.

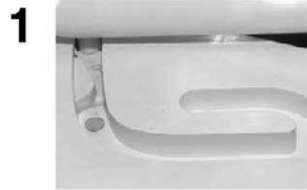
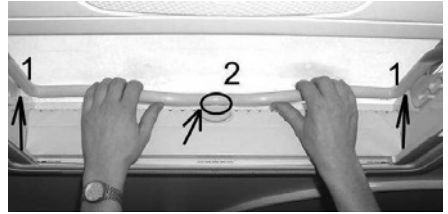

⚠ WARNING: The retaining catches are designed to hold the skylight open to the selected position. In gusty or windy conditions the Skylight should be closed to prevent it from being blown fully open or slamming shut.

9.8 Blind and Flyscreen



The blind and flyscreen operate Independently of each other and are engaged by connecting to each other and sliding.

Safety precautions:

5. Repairs should be carried out only by trained personnel.
6. Inform an approved dealer in case of defects and malfunctions.

7. Before starting off, check the rooflight for damage in the acrylic dome (tension cracks) and the winding mechanism which could arise owing to, for example, branches and other natural causes.
8. Do not step in the acrylic dome.
9. Close the roof light before starting off (check whether it is locked).
10. Do not leave the vehicle with the rooflight open (danger of burglary or from rain).
11. Do not open in strong wind or rain.
12. Before opening, remove snow, ice, dirt, etc. from the acrylic dome.
13. Malfunctions are to be repaired by an approved dealer at once.
14. Do not use caustic detergents (danger of tension cracks in the acrylic dome).
15. Do not operate whilst the vehicle is moving

Care instructions:

- Please clean the acrylic panes with the Seitz Acrylic Cleaner.
- Stains and light scratches on the acrylic pane can be removed by using the Seitz
- Acrylic Polish and the Seitz special polishing cloth.
- Use talcum powder (4 times yearly) to care for the rubber seals
- Clean the blinds only with water and mild soap suds
- The guarantee becomes null and void if these instructions are not followed.

9.9 Cab Seat Swivel



To turn the swivel, slide the BLACK lever forwards and adjust to the required angle. Before driving off ensure the locking mechanism is fully secure.

9.10 Omnistep slide-out step

Operation

Press the "step out" key to bring the step out until it reaches the end of its run or comes up against an obstacle. The step does not come out if the engine is running. Press the "step in" key to take the step back until it reaches the end of its run or comes up against an obstacle. The step goes back in automatically when the engine is running. In this situation the buzzer sounds until the step is fully closed.

Maintenance

Dirt and frost can prevent the step from operating properly. In this case the rails and moving parts should be cleaned or defrosted.

In case of electric break down

If the step does not retract by the motor

- Remove the front plate of the step. (Fig. 1)
- Remove the connection between the footboard and the arms (with screwdriver and wrench S10).
- Slide out the footboard.
- Reinstall the front plate.

Current drawn

- Working current: 5 A
- Blocking current, when fully extended or retracted: 14 A



Fig. 1 Front plate

9.11 Thule 5200 Awning

General remarks:

- An awning is a sun and not a rain protection. The awning should be in closed position in case of storm, snowfall or heavy rainfall.
- The awning cannot be used without putting out the support arms.
- The fabric may not be rolled up wet for a longer period.
- Clean the awning only by using water or OMNI CLEANER.

Users instructions:

- Adjust the crank to the required height. Introduce the crank arm into the bayonet joint. Turn the handle and unroll the awning to a distance of 1m maximum. The awning will only open after a couple of turns.

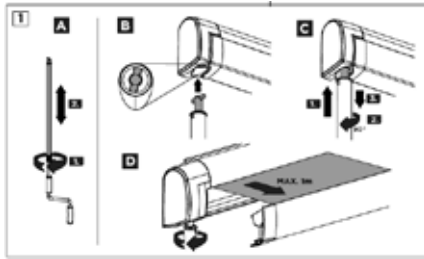

Fig. 1

- Slide the support arms out of the front profile of the awning and rotate down.

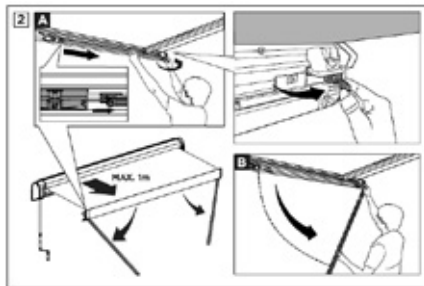

Fig. 2

- Adjust the legs to the required height to reach the ground and lock in position. With the leg supporting, wind the awning out fully and ensure the leg is vertical. Note: Never pull out the support legs so high that the fabric jams between the arms and the box

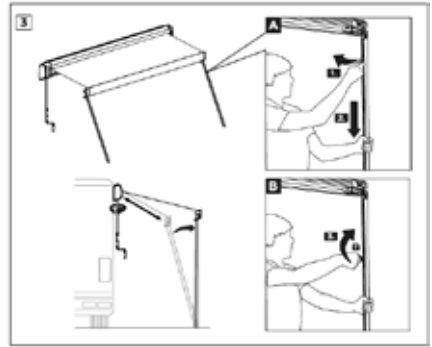

Fig. 3

- The fabric can be tightened by rolling up a little.

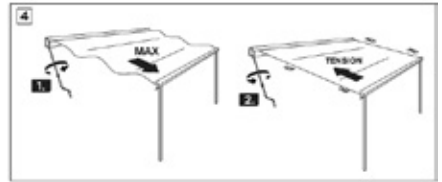

Fig. 4

- Fasten the support arms into the ground with the pegs supplied. When raining lower one side of the awning to allow the water to run down the fabric and not pool on top. Prevent the fabric from flying up by a sudden gust of wind by using the optional hold down kit.

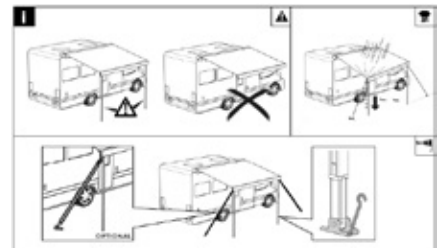

Fig. 5

- To close the awning follow the above in reverse. Wind the awning in to a distance of 1m and then fold up the legs and slid back into the front profile to store.

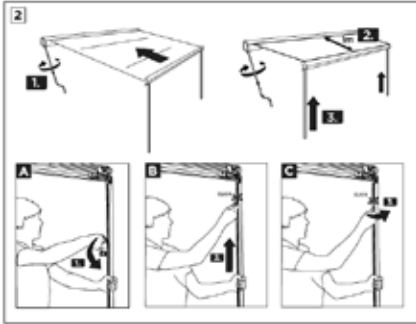

Fig. 6

Note: Never put out the support arms that high, that the fabric jams between the arms and the box.

22. The front profile locks automatically when rolling up. Remove the crank handle and store away.

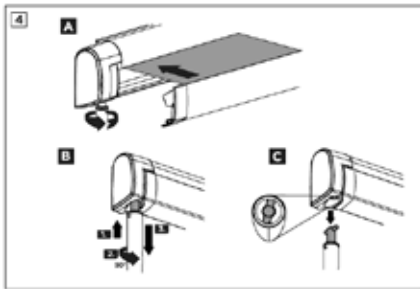

Fig. 7

9.12 TV aerial connectivity

The connection points at the TV positions within the motorhome, are in turn connected to a single external connection on your motorhome.

Located within the mains inlet fitting on the side of the motorhome, if an external antenna or site supply is connected at this point, the signals from that external antenna or site supply will become available at the TV position(s).

9.13 Care of laminate tops, tables, furniture and doors

DO NOT use abrasives, chemically treated cloths or aggressive detergents as these may cause damage.

DO NOT place hot objects on laminated surfaces i.e. tops, tables. Any temperatures 70°C and over will cause permanent damage.

Clean worktop surfaces, furniture and door fascias with a soft, slightly damp cloth, dry off with a soft cloth.

9.14 Furniture doors

During normal travelling, vehicle vibration and flexing may cause some of the furniture doors to become out of alignment. For your convenience many hinges are adjustable.

9.15 Table storage

Tables should be stored away in their dedicated storage locations when travelling (on the base of the rear offside bed top). Ensure they are securely clipped into place whilst in transit.

To avoid damage, care must be taken when removing tables from their stored positions.

9.16 Shower

When using the shower, always ensure that the shower door is fully closed thus avoiding water spray on unprotected areas.

- Orbit shower heads are provided with a button at the side of the head to allow users to control the flow of water. Care should be taken as water may become hot temporarily when switched on until it mixes and regulates.
- Small children should be supervised at all times when using the shower.
- We recommend unfastening the shower head before travelling and storing safely to prevent it becoming detached whilst travelling.

9.17 Colour reference

The colour code for touch ups or resprays for all Ford vehicle paintwork is Grey Matter PN4EG.

Please be aware that colours can fade over time, and therefore, if the vehicle is more than a few years old, it is suggested a colour match be obtained.

9.18 Sliding Door Flyscreens

Operation

The sliding door flyscreens run on tracks mounted to the floor and the furniture panels above and moves across from the side. They are tensioned with cords that are fixed at floor level near to the side. When the vehicle door is open pull the blind from the central part of the vertical handle avoiding twisting to close the blind. Ensure flynet is open before closing the vehicle door.

Care

Clean only with a damp sponge ensuring dirt build that would affect the running tracks is removed. Use only clean water with mild suds or a vacuum cleaner. In order to avoid material fatigue, do not leave the flyscreen closed for a long period. Take care with high winds when the flynet is closed.



9.19 SCA Pop-Top Roof and bed

⚠ WARNING: Use upper bunks for sleeping only, with the provided protection against fall out in position.

⚠ WARNING: Care shall be taken against the risk of fall out when the upper bunks are being used by children, especially under 6 years of age, these bunks are not suitable for use by infants without supervision.

Opening the Elevating Roof

Note: Please make sure to open at least one door or window so that air can escape when opening the roof.

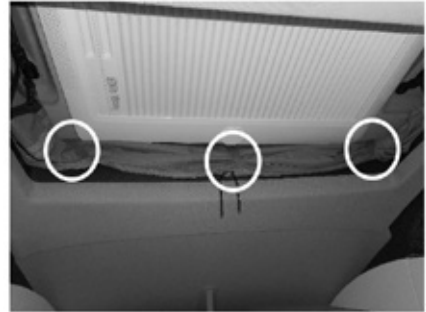

- Open the Velcro fasteners holding the tent fabric (3 fasteners)

Note: Risk of damage to the tent fabric if the fasteners are not opened!



- Open the Click-Lock catches of the roof on both driver's and passenger's side
- Release the locking of the roof according to the following four steps:



- Pull the turning handle of the locking mechanism upwards



- Turn the locking handle in a counter clockwise direction to release



- Fold the turning handle downwards



- Unhook the locking mechanism from the bracket and fold up and fix on the magnet on the roof

These steps must always be executed at the driver's side as well as the passenger's side.

Note: After releasing the locking mechanism, it is mandatory to fold up the turning handle and subsequently secure the locking mechanism at the magnet on the roof shell in order to avoid damaging the tent fabric!



- The elevating roof can then be pushed upwards by means of the two handles on the roof. This should be done evenly from both sides to avoid twisting the roof and causing damage to the hinges.



- To access the upper bunk use the folding bunk ladder stored in the rear nearside bed. The ladder hooks on to the brackets on the front section of the roof hatch.



- Fall-Out protection is provided when using the upper bunk. The net is stored under the mattress and is secured to the handles on the roof using the adjustable straps on the upper rail.

Closing the Elevating Roof

Note: Please make sure to open at least one door or window so that air can escape when closing the roof.



- Ensure all the panels on the tent are zipped closed and the fall out protection is stored away under the mattress.



- Check once more that the locking mechanism each side has been fixed to the roof shell by the magnets.
- Fix the internal strap across the roof tent using the plastic clips to ensure the tent folds inwards when closing.



- Pull the roof down carefully using the strap at each side together ensuring the tent fabric will not be jammed in this process.

Note: The roof should be pulled down evenly and not twisted as this may cause damaged to the hinges.

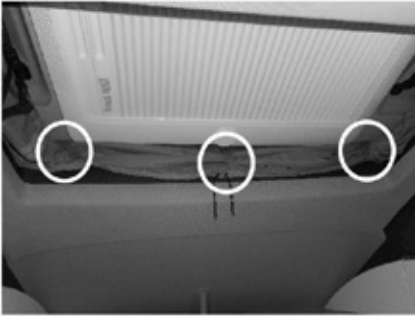

Fold up the remaining tent fabric thoroughly in the front area and fix using the three Velcro fasteners.

Note: Make sure that the tent fabric will not be jammed in this process.

- After that, the roof should be locked according to the following steps:



- Fold-the tent fabric up thoroughly in the area of the locking mechanism.



- Release the locking mechanism from the magnet and hook on to the bracket on the frame



- Pull the turning handle downwards and turn it in a clockwise direction to tighten the locking mechanism.



- Fold the handle upwards to lock in position.

These steps must always be executed at the driver's side as well as the passenger's side.

Note: Make sure that the tent fabric is not jammed in this process.



- Close the Click-Lock of the roof (driver's side as well as passenger's side) to ensure the locking mechanism cannot pull free.

9.20 Cab Radios

For full details of the Ford infotainment unit, see the glovebox handbook and information provided with the Ford base vehicle.

9.21 TV Brackets

In some models a bulkhead mounted bracket can be fitted to mount the TV on. Whilst the bracket has a travel lock it is good practice to unclip the TV from the bracket and store securely for transit.

9.22 External BBQ point

Models equipped with an external barbeque point can be used to power any gas appliance suitable for the gas used in the motorhome, at the working pressure shown on the label in the barbeque outlet box. Please note when using the outlet that the fitted regulator will allow a maximum of 1.5kg per hour of gas to be taken from the gas bottle. Therefore the consumption of gas from both the appliances within the motorhome and the appliance connected to the barbeque point cannot exceed a total of 1.5kg per hour at any one time. If you are in any doubt please consult your dealer for advice. To use point proceed as follows.

When external gas equipment is being connected, the operating pressure of the gas supply of 30 or 50 mbar must correspond with the operating pressure of the equipment that is being connected (see data plate).

The plug-in connection can only be made if the quick-acting valve is closed. The safety locking mechanism can be released by sliding back the coupling sleeve.

The coupling K-valve is designed such that the quick-acting valve can only be opened if the connection is being made via the plug-in connection. The connection is made by inserting the plug-in connection into the safety coupling.

This operation can be carried out using one hand. After uncoupling the equipment, seal off the valve opening using the protection cap.

Note: The external gas socket is only suitable for removing gas, not for feeding gas into the gas system.

9.23 The External Shower Point



The external shower point will be supplied with a separate shower head and hose assembly.

To connect the shower hose, simply slide the lid on the housing up and remove the blank cap by pushing the blue Hozelock fitting forward and pulling the blank out. Screw the male Hozelock fitting (supplied) on to the end of the hose screw thread and then push into the female fitting inside the housing.

To remove, push the blue Hozelock fitting forward and pull the male fitting on the hose from the housing. Replace the blank cap.

10. Motorhome Care

10.1 Winterisation	108
10.2 General care	110
10.3 Condensation	112
10.4 Changing Exterior Bulbs	113
10.5 Interior	113
10.6 Side Walls, Roof Lining	113
10.7 Soft Furnishings	113
10.8 Leather care	113
10.9 Work Surfaces	113
10.10 Cupboard Catches	113
10.11 Bathroom, Shower Room and Kitchen Equipment	113
10.12 Furniture	114
10.13 Kitchen Drainer and Cutting Board	114
10.14 Changing interior light fittings	114
10.15 Caring for the environment	114
10.16 Rear Bed instructions (Trekker and Trekker X)	114

10.1 Winterisation

The Swift Group recommends the following winterisation points for customers:

Servicing

Arrange (in advance) the yearly service and habitation check, if the motorhome's next service is due while the vehicle is stored.

Plumbing

Water expands as it is frozen, and so trapped water, when it expands, can damage the tap/ valve /pump or pipe it is trapped within. For this reason, (in addition to reasons of hygiene), the water system should be fully drained when not in use, particularly in colder weather.

- Use the switches located in the upper locker in the vehicle to open both the fresh tank and water waste tank drain valves. Ensure that waste water drains into a designated waste water collection area, either directly or by collecting the water in a container for later disposal.
- Open the drain valve (yellow handle) next to water heater, and leave open. See section 7.2.
- Fully open all the taps and shower mixer, move mixer position to the middle, and leave all taps in the open position.
- Unscrew the shower head and shower hose, shake out remaining water and allow water to drain. It is advised to leave the shower head and hose disconnected.
- Run pump for a short time, until all water is expelled.
- After a short while the majority of water will have left the plumbing system. At this point however it is still important to ensure that the pump itself is 'dry'. During this part of the winterisation, a suitable absorbent cloth or container should be used to catch a small amount of spilled water that will result.

Disconnect the pipe work from the pump by pulling the blue quick release tabs, at either side of the pump, at right angles to the pipe work, then pulling the pipe and connectors from the pump. See Fig.1 Run the pump for a short while to expel any remaining water within the pump.

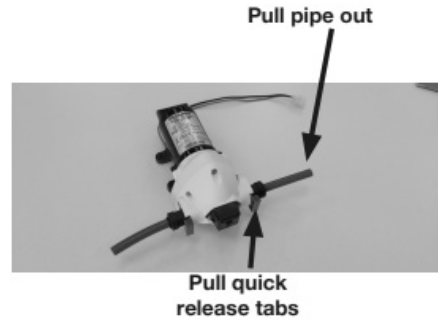

Fig.1

Electrical

- If vehicle is being stored while connected to 230v Mains Hook-up:
- Ensure that the leisure batteries are connected and the 40A local fuse(s) is connected.
- The isolator switch on PSU should be in the 'ON' position, however, the control panel should be switched 'OFF'.
- Vehicles can be left in this condition for extended periods, with the charger operating to maintain the battery. However, periodic maintenance and inspection is recommended, this should include the battery condition.

If vehicle is being stored not connected to 230v Mains Hook-up:

- Charge the leisure batteries for 24 hours prior to placing motorhome in storage.
- Ensure the isolation button on PSU is in the 'OFF' position.
- The batteries should not be adversely affected by winter temperatures but the level of charge should be maintained to maximise the life span of the batteries. This can be achieved using an automotive type battery charger as and when required.
- Disconnect the vehicle battery negative terminal. Check the charge of the battery every three months. (See maintenance section of the Ford Handbook for vehicle battery care)

Gas system

- Ensure the gas supply is isolated at the gas bottle, and ensure that the gas manifold taps are off.
- Check the age and condition of the high pressure gas hose and regulator, and replace if required.

Appliances

Check the battery expiry date on the smoke alarm and CO detector and replace or remove as required.

- Ensure the fridge is turned off.
- Clean the inside of the fridge.
- Prop the fridge door open, and if possible, the internal freezer compartment door for ventilation.
- Ensure all hob / oven / microwave surfaces are clean.
- If the motorhome is going to be left connected to 230v supply while not in use, ensure the microwave is unplugged.
- Clean the toilet and empty the cassette and lubricate the seals with an acid free lubricant such as Thetford High Grade Seal Lubricant. See Thetford toilet Users manual

Exterior (Body / Chassis)

- Ensure that all windows, skylights and access doors are closed and secured.
- Ensure all fixed ventilation points (high and low) are clear from debris and obstructions.
- Ensure the vehicle is not parked where falling debris (i.e. leaves, tree sap) could cause damage.
- Avoid leaving the vehicle parked in soft ground, long grass or a potential area where standing water may form.
- Lubricate relevant points on the chassis.

Wheels and Tyres

- Do not store in one position with partially deflated tyres. The tyre walls will suffer and do present a real danger of blow outs, especially when travelling at faster speeds than are allowed in the UK. The wheels should be turned every couple of weeks. If you are removing the wheels, follow the jacking procedure for changing a wheel. Check your tyres regularly for signs of age and deterioration, particularly wear, cracking and blistering. If in doubt consult a reputable tyre fitter.
- A purpose made cover maybe used, but please ensure the cover is a good fit, breathable and securely fitted.

Note: A poorly fitted cover can rub and damage the bodywork. Non-breathable covers will encourage mould to grow.

Interior (Furniture / furnishings)

- Open all lockers and internal doors, to ensure good circulation.
- Remove cushions and store them in a dry location or ensure all cushions are placed in a well ventilated area.
- Close all blinds and curtains. Customers are reminded to check the tension on blinds after storage if left closed for long periods.
- Thoroughly ventilate the motorhome by opening doors or windows periodically.
- Placing water absorbent crystals in the van during the winter months, will help reduce moisture levels and mould growth.
- We do not recommend leaving portable heaters in the van unattended.

Recomissioning the Water System

Re-connect the water pump by positioning the pipe connectors into the pump housing and pushing the blue tabs into position. It is advisable, after a period on non-use, to flush the water system with a sterilising fluid product suitable for use with stainless steel components. Fill the fresh water tank with water and sterilising fluid (Refer to sterilising fluid instructions for the amount to use). Turn the pump on and open all the taps, ensuring that the water drains away safely to the waste tank.

When the waste tank is full empty the fluid into a designated waste water area. Re-fill the tank with fresh water and flush through the system

as described above; repeat this until all traces of the sterilising fluid have been flushed out.

Prepare the toilet system by adding water and Thetford fluid to the toilet waste tank.

Appliances

Before starting motor caravanning after storage, check all gas appliances and electrical points.

Note: Preferably not less than once a year, the electrical installation should be inspected and tested by a qualified electrician.

After storage it is advisable to air the Motorhome and clean throughout, especially cooking appliances and the refrigerator.

Replace the bedding if they were removed for storage.

⚠ WARNING: Always follow the manufacturers recommended procedures after use of fitted equipment in the Motorhome, before storing for any length of time.

10.2 General care

For care of the vehicle battery please refer to the Ford handbook in section 'Trouble Shooting'.

All moving parts should be checked for free operation.

Clean all cooking appliances and refrigerator. Lubrication should be carried out at the points illustrated in the general notes on chassis maintenance.

Charge up the on-board batteries every 2 months.

Leave the refrigerator door open. Leave furniture doors and lockers open to allow air to circulate fully.

Modifications - DIY work

Owners need to be aware that carrying out DIY modifications to your motorhome may in certain instances, invalidate the warranty cover and could also affect the safety and structure of the vehicle.

⚠ WARNING: WD40 is not recommended for external or internal use

WD40 attacks paintwork and sealants. If a lubricant is required for Interior hinges, Sliding door tracks, Bottle box hinges, Exterior door hinges, Plastic tracking etc. We recommend "Ambersil 40+" this is readily available from most DIY/Automotive retailers including Halford's .

Before carrying out any DIY work within the warranty period, please check with your Swift Group dealer.

Paintwork

Proper care involves washing the motorhome regularly with a mild detergent rinsing with cold water and leathering off. A good quality, similar coloured car wax may also be applied which will make washing even easier.

Please note: Do not use abrasive-eleaning agents, on the exterior of your motorhome. Stubborn stains may be removed using a soft cloth and mild detergent.

⚠ WARNING: Overzealous use of detergents may loosen the decals and / or badges.

Acrylic Windows

The windows in your motorhome are fully double glazed and, with care, will remain sparkling and scratch free.

Acrylic (Plastic) Window Condensation

Unlike domestic double glazed windows, your motorhome windows are not vacuum sealed. Condensation can appear on the window or between both panes. This does not mean there is something wrong with the window or that it is leaking. It is a natural occurrence caused by different temperatures inside and outside, air moisture and properties of acrylic itself. Condensation will disperse after some time. In most cases, condensation can be prevented by adequate ventilation of the vehicle.

Acrylic (Plastic) Window Cleaning

The material used to produce most caravan and Motorhome windows is acrylic plastic. While the acrylic used is very durable, it is able to be scratched with relative ease. Therefore, care must be taken when clearing your vehicle. Never use abrasive and corrosive substances or solvents on windows, such as turpentine, spirit, dishwasher detergents, as they will damage acrylic and/or print. We recommend cleaning with generous amounts of water or a mild cleaner, intended for use on acrylic. Always use a moist sponge or a moist soft cloth as cleaning with a dry cloth can damage the acrylic and leave scratches. When all the dirt has been removed, dry with a leather or similar type of cloth. Care should be taken when using a drying cloth that it is clean and free from grit. Never clean the windows with a high pressure washer. A carwash can also damage the windows and cause scratches or other damage. The catches and stays do not require lubricating.

Removing Tar

Use a proprietary tar remover on your double glazed windows; (available from most leading car accessory or do-it-yourself shops). Do not use petrol or other chemicals.

Note: The use of a pressure washer on the exterior of your motorhome is not recommended as this may damage the transfers.

10.3 Condensation

What is condensation

Condensation is the process of change of water from its gaseous form (water vapour) into liquid water when it comes into contact with a surface that is cold. Condensation generally occurs when warm air cools quickly and loses its capacity to hold water vapour, and as a result water vapour condenses to form droplets.

Why condensation occurs

Condensation occurs when warm moist air meets a cold surface. The level of condensation will depend upon humidity levels, how moist the air is and how cold the surfaces are they come into contact with.

If the temperature falls below the dew point temperature, it is quite normal for condensation to occur on any material within the motorhome that is cold, for example the external walls, plastic windows etc.

When condensation occurs

Condensation occurs usually in winter months, because ambient temperatures are colder (leading to cold surfaces) and windows and roof vents are opened less so the moist air cannot escape.

Where condensation occurs

Condensation will occur where warm moist air is put into the atmosphere in areas such as in bathrooms (during showering) and in kitchen areas (during cooking).

In the enclosed space of a motorhome, the moist air from the kitchen or bathroom areas will inevitably transfer to the rest of the vehicle, which in turn condenses on cold surfaces leading to visible water droplets. This issue is compounded by warm moist air being generated from normal breathing.

Condensation will also form in cold areas where air movement and ventilation is restricted (e.g. cupboards, wardrobes, under beds, etc.)

What is important

It is important to provide ventilation and air flow, so that warm moist air can escape, or be externally cooled, and to use the heating reasonably by not making the motorhome too warm such that people perspire, as this will only serve to generate more moist air and therefore more condensation.

However, in particularly cold periods, where the external ambient temperatures are low, condensation may still form on external walls as the insulation levels may well not be thermally able to cope with the difference between the internal and external temperatures.

How can you prevent condensation

Provide ventilation so that moist air can escape.

- a. Good ventilation of the vehicle when cooking or when drying clothes, footwear or pets is essential. Observe when windows begin to show signs of misting and increase ventilation by opening a window slightly by 1 cm or opening a roof vent, as these will help, but keep the habitation door closed as much as possible to retain heat.
- b. If drying damp clothes or towels, open a window to ventilate the area and allow the moist air to escape.
- c. Try to make sure that the caravan is partially heated. It can take a long time for a cold caravan to warm up, so it is better to have a small amount of heat for a long period than a lot of heat for a short time.
- d. After showering, keep the bathroom window or skylights open, and shut the bathroom door long enough to dry off the room.
- e. Fixed ventilation is provided in the vehicle, specifically through high level vents within the skylights and low level vents through the floor, it is important not to block these.
- f. Electrical heating is dryer than gas heating, and introduces less moisture into the atmosphere. Do not use additional portable paraffin or flue-less gas heaters at all.
- g. If left unoccupied and unheated for long periods of time the temperatures can soak down thermally into the entire product and become very cold. Whenever possible, put the heating on at a low level before use by pre heating in cold weather.

- h. Even with reasonable ventilation it is likely if the temperature is less than 50C and the humidity is high that condensation will occur. Ideally the temperature should be kept about 20oC when occupied.

Mould Growth

Any sign of mould growth is an indication of the presence of moisture and if caused by condensation gives warning that heating or ventilation may require improving.

New vehicles

New products take a long time before they are fully 'dried out' because of the moisture in the materials used during manufacture. While this is happening extra heat and ventilation will be required.

10.4 Changing Exterior Bulbs

ALWAYS REPLACE LIKE FOR LIKE

For instructions on the replacement of road lighting bulbs, please see the information provided by Ford, or seek assistance from an automotive repairer

10.5 Interior

Follow these guidelines to ensure your investment is receiving the very best attention.

10.6 Side Walls, Roof Lining

A simple wipe over with a damp cloth and a very mild detergent is all that is needed.

10.7 Soft Furnishings

Should be vacuumed occasionally to remove grit and sand and help to keep its smart appearance and ensure long life. The upholstery can be cleaned with a mild, reputable upholstery cleaner. It is recommended that the curtains and pelmets are specialist cleaned only. The foam used in cushions are manufactured to meet fire regulations. It requires time to return to its normal position after prolonged use.

Clean and dust the upholstery and if possible remove before placing the Motorhome into winter storage. Alternatively, stand the cushions on their edges to allow circulation of air. This will reduce the possibility of dampness from condensation. Keep curtains or blinds closed, to minimise fading of furniture.

If the blinds and/or flyscreens remain down for a prolonged period of time, re-tensioning of the springs will be necessary before re-use.

10.8 Leather care

- Leather furniture, if fitted in your vehicle, requires little maintenance. Regular care of leather does ensure its lasting quality and some general rules for regular cleaning and maintenance are:
- Clean the leather with a soft damp cloth taking care not to soak the leather
- For a more thorough clean, use the Bridge of Weir Leather cleaning and protection kit available directly from the distribution centre
- Do not use saddle soap, wax polishes or spray polishes
- Do not use any product or any method of cleaning not recommended by the manufacturer
- Avoid letting buckles, studs and zips come into any direct contact with the furniture
- Avoid drying out the leather by taking extra care where there is heating or blown air outlets

10.9 Work Surfaces

You should not stand very hot items on any of the work surfaces.

10.10 Cupboard Catches

It is advisable to lightly oil all cupboard catches, sliding bolts and hinges from time to time.

10.11 Bathroom, Shower Room and Kitchen Equipment

All the Thermoplastic parts in these areas have easy clean surfaces. To ensure long life and prevent damage you must not use any cleaning materials at all and ensure water temperatures do not exceed 70°C, (putting cold water in first is suggested). After every use, it is essential that you rinse with clean water only and wipe with a soft damp cloth.

Failure to follow these simple instructions may result in premature failure or cracking which will not be covered by any guarantees (including extended warranties).

10.12 Furniture

A simple wipe over with a damp cloth should be all that is required. Polishing with a proprietary brand of wax polish enhances and maintains furniture in showroom condition.

It must be remembered that because the frames of some doors are made of ash, which is a natural product, they can be affected by temperature and humidity and may bow under certain conditions. As conditions change they should revert to their original positions.

10.13 Kitchen Drainer and Cutting Board

You should not stand hot items on to these items. To wash use only warm soapy water, do not use chemicals and bleach.

10.14 Changing interior light fittings

The light fittings in your motorhome are LED, with no user serviceable parts. In the unlikely event of failure of one of these lamps, the entire lamp will need to be replaced - several types of LED lights are intended for semi-permanent installations using self adhesive mounts etc., and dealer assistance may be required should damage or other need for replacement occur.

10.15 Caring for the environment

After many years of service you may decide that your motorhome has become beyond economic repair and should be disposed of. Please ensure that you comply with the end of life vehicle legislation and take it to an authorised treatment facility where it will be properly dealt with to minimise any negative environmental impact. The transaction will be logged at the DVLA, identifying that you are no longer the owner of the vehicle.

10.16 Rear Bed instructions (Trekker and Trekker X)

⚠ WARNING: The metal bed support rails must be in position before the bed tops are lowered. Failure to do so can result in damage to the bed tops or hinges.

Please ensure the transit straps are engaged when the beds are folded up in the stored position.



- Remove the support rails stored in each side bed

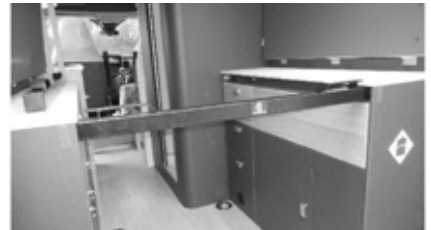

- Secure the rear support rail in position using the magnets with the handle facing upwards





- Release the strap securing the offside bed and fold the bed down on to the rail



- Lower the bed onto the support rail



- Release the strap securing the nearside bed and hold the bed as you back away towards the front of the van



- Unfold the two infill mattresses and place in the gap either side of the main mattresses



- Secure the front support rail in position using the magnets with the handle facing upwards



- Attach the short bunk ladder to the brackets on the front of the bed base

⚠ CAUTION: When storing the support rails away care should be taken not to trap fingers as the rail is secured on the magnets.

Rear Bed instructions (Trekker XL)



Step 1: Remove the Near side bed cushions and release the front fascia flap at the top of the bed



Step 2: Fold back the seat base.



Step 3: Standing in the middle of the bed unfold the seat base..



Step 4: Standing in the middle of the bed pull upward the sliding section of the frame..

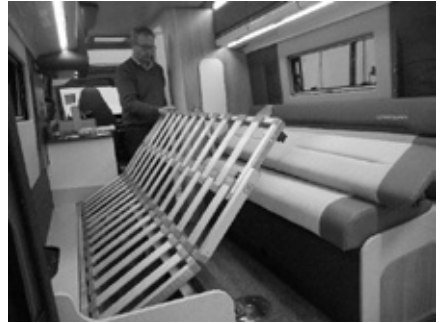

Step 5: Moving to the end of the bed lower the extended bed frame over the off side seat base.



Step 6: Lowering the bed frame, ensure hooks locate into the off side bed base top



Step 7: Once the frame is located Turn the base cushions over. This creates a flat bed base.



Step 8: The back rests are positioned in the middle of the bed. With the backs surface aiming upwards

CAUTION: Care should be taken not to trap fingers in the folding parts of the bed.

11. Technical information

11.1 Specification	120
11.2 Water Tank Capacities	122
11.3 LPG Tank Capacity	122
11.4 Van Conversion Towing Capabilities	122
11.5 Jacking Points	123
11.6 Consumer circuits floor	124
11.7 Power circuits	125
11.8 Consumer circuits roof	126
11.9 230v circuits	127

11.1 Specification

Model	Trekker		Trekker X	
Roof Profile	Pop Top Panel Van		Pop Top Panel Van	
Engine	165bhp Manual	165bhp Auto	165bhp Manual	165bhp Auto
Engine Power	165bhp @ 3500rpm		165bhp @ 3500rpm	
Engine Torque	390Nm @ 2750rpm		390Nm @ 2750rpm	
Engine Capacity	2.0L		2.0L	
Wheel base	3.30m / 10' 10"		3.75m / 12' 4"	
Designated Passenger Seats excluding Driver	3		3	
Berths (sleeping positions)	4		4	
Overall Length (no ladder)	5.53m / 18' 2"		5.98m / 19' 7"	
Overall Width	2.07m / 6' 9"		2.07m / 6' 9"	
Overall Width (mirrors folded)	2.11m / 6' 11"		2.11m / 6' 11"	
Overall Width (mirrors extended)	2.47m / 8' 1"		2.47m / 8' 1"	
Overall Height (pop up roof down)	2.98m / 9' 9"		2.98m / 9' 9"	
Maximum Technical Permissible Laden Mass (A)	3500kg		3500kg	
Mass in Running Order (B)	2970kg	3015kg	3100kg	3145kg
Maximum User Payload (A-B)	530kg	485kg	400kg	355kg
Unladen Weight	2831kg	2876kg	2961kg	3006kg
Essential Habitation Equipment	0kg		0kg	
Thermal Insulation Grade	One		One	
Bed Sizes				
Rear Bed	185cm x 123cm / 6'1" x 4'0"		185cm x 136cm / 6'1" x 4'6"	
Roof Bed	205cm x 130cm / 6'8" x 4'3"		205cm x 130cm / 6'8" x 4'3"	

Notes:

1. The Maximum User Payload includes:

Conventional load (this is the allowance for passengers)

Essential habitation equipment (items and fluids required for safe and proper functioning of habitation equipment)

Optional equipment (items available from the manufacturer over and above the standard specification)

Personal effects (those items not covered by the above)

2. The Mass in Running Order is the mass of the unladen vehicle including a 75kg allowance for the driver plus engine coolants and 90% of the fuel tank and an 11kg allowance for LPG.

3. The Mass in Running Order is calculated with the fresh water tank and water heater empty. If you travel with water in the fresh water tank or water heater then the payload will reduce accordingly.

4. PLEASE TAKE CARE TO ENSURE THAT YOU HAVE ALLOWED FOR THE MASSES OF ALL ITEMS YOU INTEND TO CARRY IN THE MOTOR CARAVAN, e.g. passengers, optional equipment, essential habitation equipment and personal effects, such as clothing, food, pets, bicycles, sailboards, sports equipment etc.

5. **⚠ WARNING:** - UNDER NO CIRCUMSTANCES SHOULD THE MAXIMUM TECHNICAL PERMISSIBLE LADEN MASS OF THIS MOTOR CARAVAN BE EXCEEDED.

* Estimate

Model	Trekker XL	
Roof Profile	Pop Top Panel Van	
Engine	165bhp Manual	165bhp Auto
Engine Power	165bhp @ 3500rpm	
Engine Torque	390Nm @ 2750rpm	
Engine Capacity	2.0L	
Wheel base	3.75m / 12' 4"	
Designated Passenger Seats excluding Driver	1	
Berths (sleeping positions)	2	
Overall Length (no ladder)	5.98m / 19' 7"	
Overall Width	2.07m / 6' 9"	
Overall Width (mirrors folded)	2.11m / 6' 11"	
Overall Width (mirrors extended)	2.47m / 8' 1"	
Overall Height	2.86m / 9' 4"	
Maximum Technical Permissible Laden Mass (A)	3500kg	
Mass in Running Order (B)	2890kg	2935kg
Maximum User Payload (A-B)	610kg	565kg
Unladen Weight	2751kg	2796kg
Essential Habitation Equipment	0kg	
Thermal Insulation Grade	One	
Bed Sizes		
Rear Bed	185cm x 185cm / 6'1" x 6'1"	
Rear nearside single	190cm x 65cm / 6'3" x 2'2"	
Rear offside single	185cm x 65cm / 6'2" x 2'2"	

11.2 Water Tank Capacities

	Fresh Water Tank	Waste Water Tank	Water Heater
All models	60 litre	55 litre	8 litre

11.3 LPG Tank Capacity

	Capacity
Trekker	2 x 6kg

Note: For technical data on the base vehicle please refer to the manufacturer's handbook.

11.4 Van Conversion Towing Capabilities

Model	MTPLM	Permissible Front Axle Load	Permissible Rear Axle Load	Recommended Maximum Trailer Weight	Gross Train Weight
TREKKER S Manual Gear Box	3500kg	1850kg	2000kg	2800kg #	6000kg
TREKKER S Auto Gear Box	3500kg	1850kg	2000kg	2800kg #	6000kg
TREKKER X Manual Gear Box	3500kg	1850kg	2000kg	2800kg #	6000kg
TREKKER X Auto Gear Box	3500kg	1850kg	2000kg	2800kg #	6000kg
TREKKER XL Manual Gear Box	3500kg	1850kg	2000kg	2800kg #	6000kg
TREKKER XL Auto Gear Box	3500kg	1850kg	2000kg	2800kg #	6000kg

The maximum trailer weight is limited by the gross train weight which must not be exceeded.

For example, with the maximum MTPLM of 3500kg, the maximum trailer weight possible is 2500kg. Reducing the weight of the vehicle by removing payload, will allow you to increase the trailer weight up to a maximum of 2800kg.

Please note that the additional weight of the tow bar and trailer nose weight increases the rear axle loading of the motor home so care should be taken that the rear axle load is not exceeded when towing.

To ensure adequate road holding, the load on the front axle, under all conditions, must not be less than 40% or more than 70% of the total weight.

Care must be taken when distributing loads. The loadings and weights above are maximums and must not be exceeded under any circumstances.

⚠ CAUTION: When fitting a towbar, it must meet certain minimum requirements as specified by Type Approval Regulations. The bar will have marked on it the approval standard (94/20/EC or 55R ECE) and the maximum download, or noseweight, that it can accept. It must fit the manufacturer's approved mounting points and must not obscure the towing vehicle's number plate.

11.5 Jacking Points

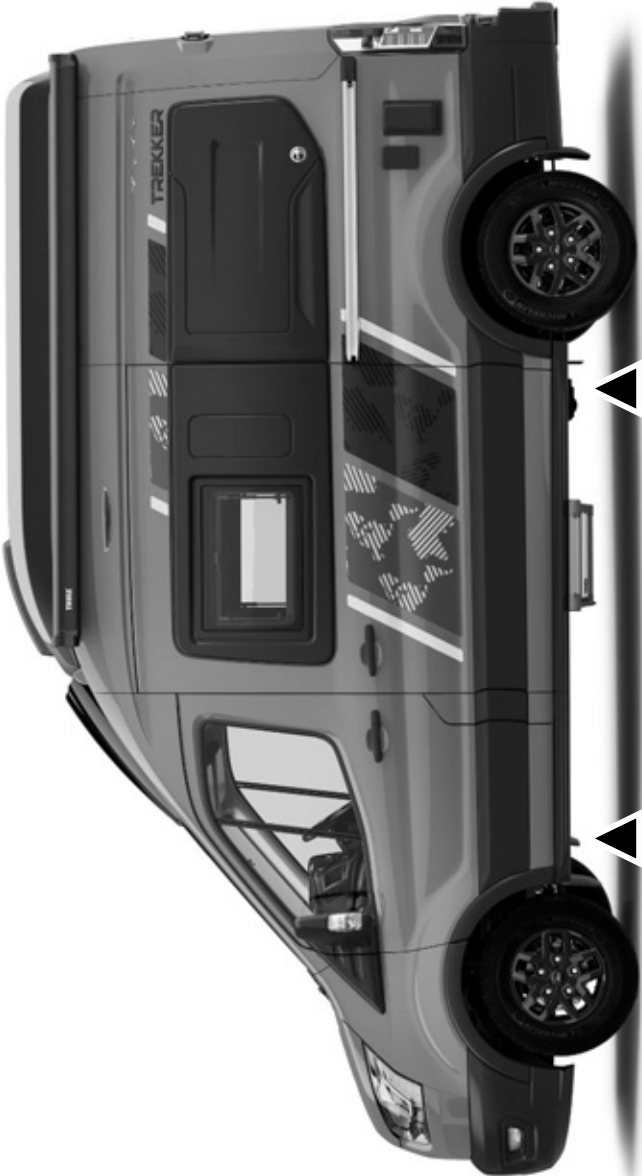

Jacking Point: ▲

11.6 Consumer circuits floor

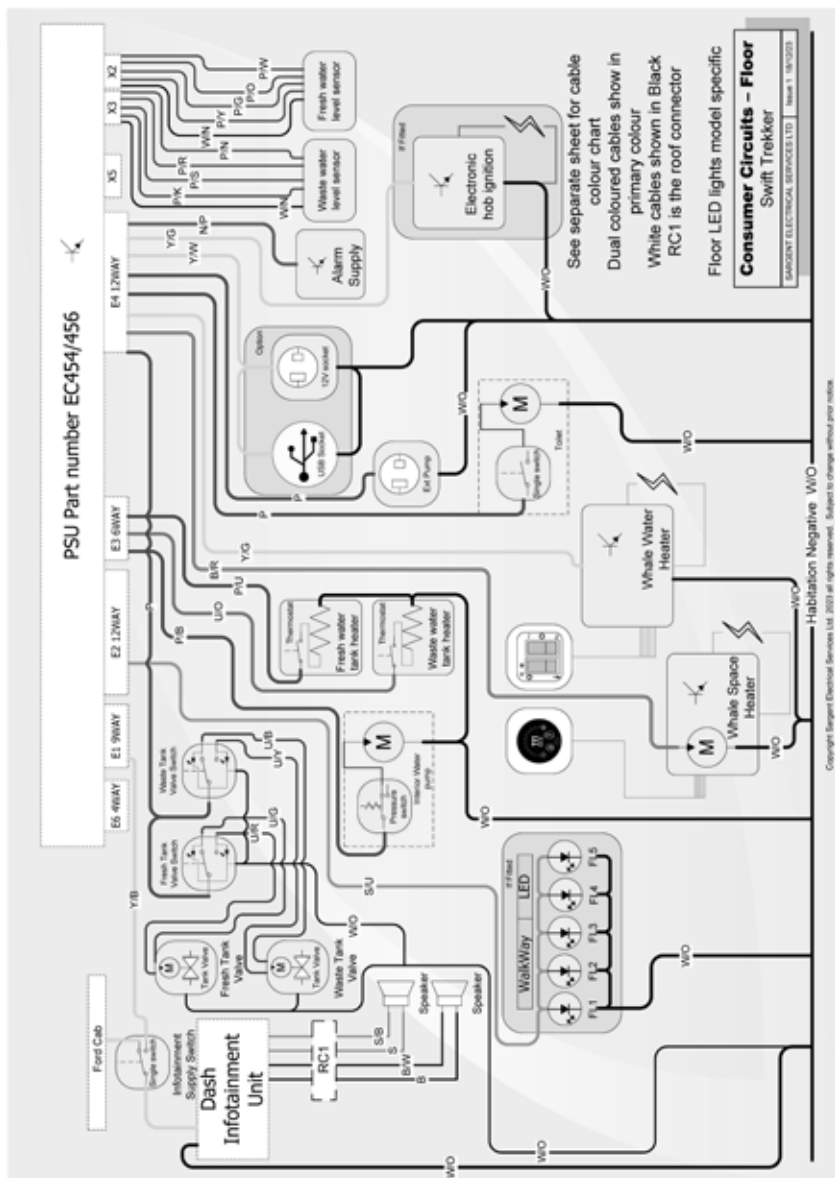

11.7 Power circuits

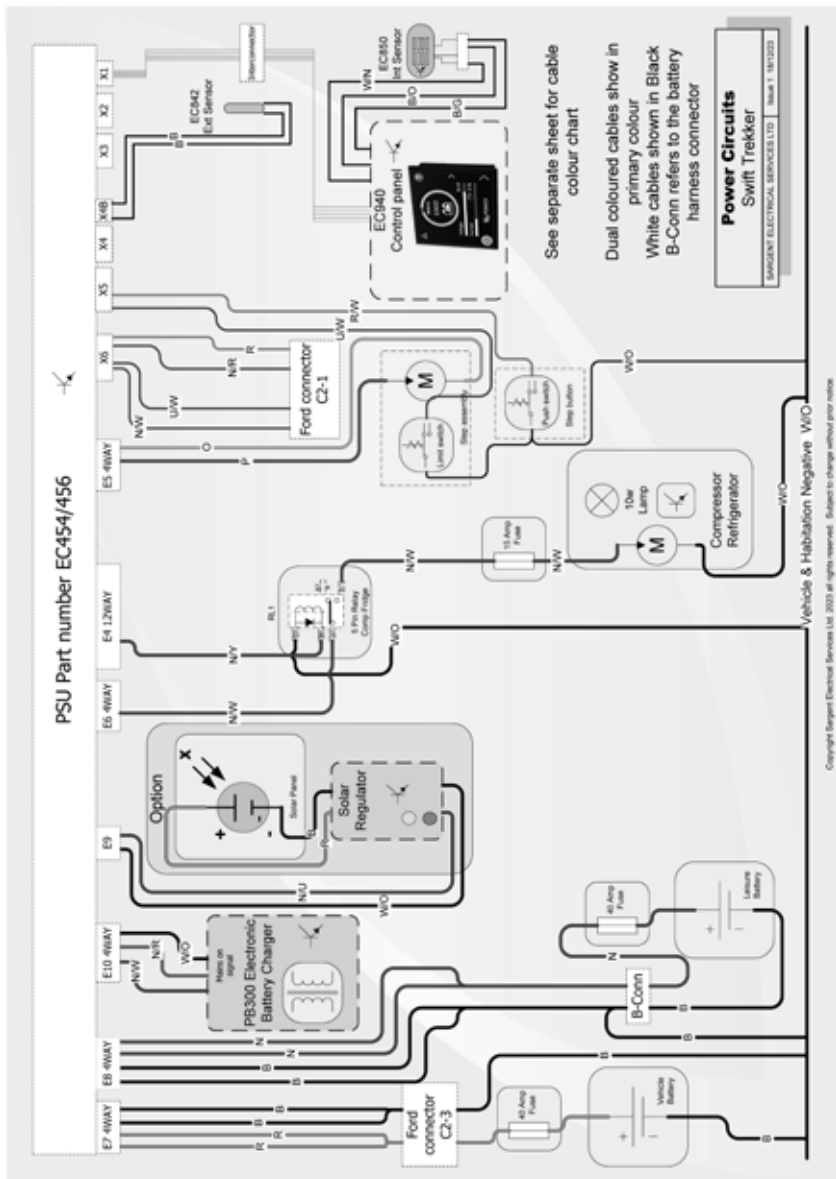

11.8 Consumer circuits roof

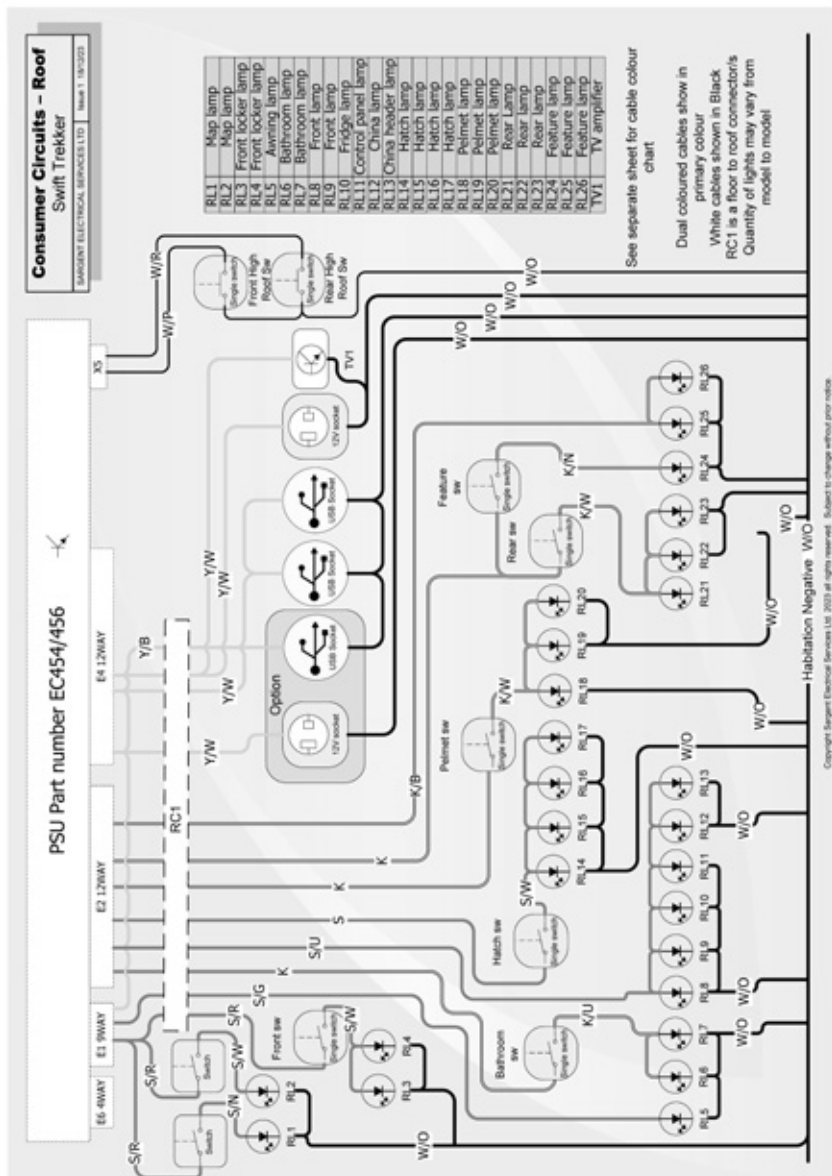

11.9 230v circuits

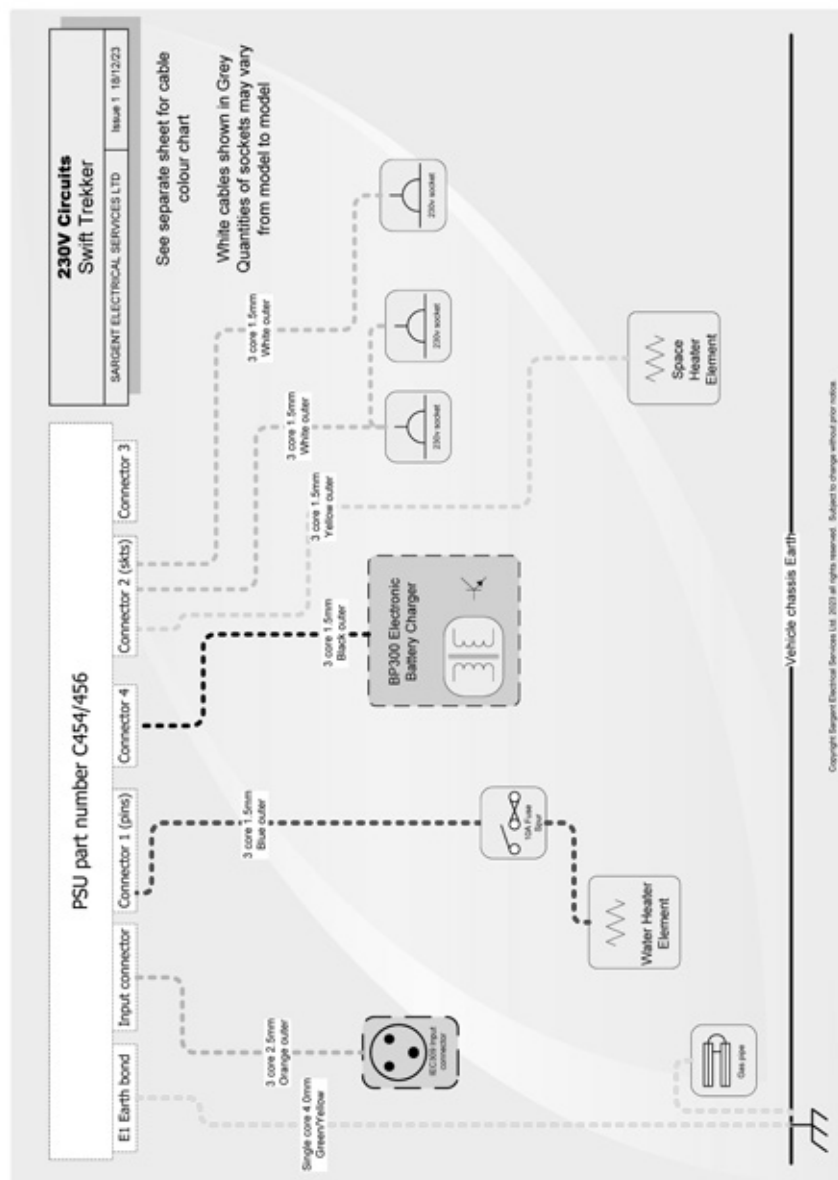

11.10 Cable colour chart

	<p>Example</p> <p>Y/U</p> <p>Yellow cable with Blue stripe</p>	<p>Cable Colour Chart Swift Group</p> <p>SARGENT ELECTRICAL SERVICES LTD Issue 1 18/12/23</p>	
12V Cable Colours			
B	BLACK	B	BLACK
N	BROWN	N	BROWN
R	RED	W	WHITE
O	ORANGE	O	ORANGE
Y	YELLOW	Y	YELLOW
G	GREEN	G	GREEN
U	BLUE	U	BLUE
P	PURPLE		
S	SLATE GREY		
W	WHITE		
K	PINK		
230V Cable Colours			
B	BLACK	B	BLACK
N	BROWN	N	BROWN
W	WHITE	W	WHITE
O	ORANGE	O	ORANGE
Y	YELLOW	Y	YELLOW
G	GREEN	G	GREEN
U	BLUE	U	BLUE

12. Useful information

12.1 Owners club	130
12.2 Spares and after sales customer service	130
12.3 Repair facilities	130
12.4 Caravan Clubs	131
12.5 Motoring Associations	131
12.6 Trade Association	131
12.7 Index	132
12.8 Change of ownership	134

12.1 Owners club

The Owners Club is a completely independent organisation run for the benefit of the motorhome owners. They have numerous rallies during the year in various parts of the country. Apart from the friendliness and companionship the Club generates it is also actively engaged in charity work for those less fortunate than ourselves. The address of the Secretary of the Owners Club can be obtained from the Swift Group website.

12.2 Spares and after sales customer service

A catalogue of spare parts are available through our Swift Group Dealer Network, from door catches through to spare wheels. Please note, all parts enquiries must be directed through your dealer, as the Swift Group does not operate a direct retail service.

We endeavour to supply parts for vehicles up to 8 years old. If the original part is no longer available your dealer should be able to source a suitable alternative.

Note: Please remember to quote chassis VIN (Vehicle Identification Number) when ordering any items from your dealer. This can be found at the bottom of the front windscreen and on the Swift manufacturers plate situated on passenger door B pillar.

12.3 Repair facilities

Should you be unfortunate to encounter damage to your vehicle, we have a number of approved workshops and dealerships with workshop facilities to undertake such repairs.

Details of which can be found via our website:
www.swiftgroup.co.uk/find-a-dealer

The enjoyment of motorhoming can be greatly enhanced by membership of one or more of the various motorhome/caravanning, motoring and holiday clubs. Here are some useful addresses:

12.4 Caravan Clubs

The Caravan Club,

East Grinstead House, East Grinstead
West Sussex, RH19 IUA
Tel: 01342 326944
www.caravanclub.co.uk

The Camping and Caravanning Club,

Greenfields House,
Westwood Way,
Coventry,
West Midlands.
Tel: 0845 130 7631 or 024 7647 5448
www.campingandcaravanningclub.co.uk

12.5 Motoring Associations

Automobile Association (AA)

Fanum House,
Basingstoke,
Hants. RG1 2EA
Tel: 08705 448866
www.theaa.co.uk
e-mail: customer.services@theaa.com

RAC Motoring Services

RAC Motoring Services
8 Surrey St
Norwich Norfolk NR1 3NG
Tel: 01922 437000
www.rac.co.uk

The Society of Motor Manufacturers and Traders Limited (SMMT)

Forbes House,
Halkin Street,
London SW1X 7DS
Tel: 020 7235 7000
www.smmt.co.uk

Green Flag

Tel: 0845 246 1557
www.greenflag.com

RBS Insurance

Churchill Court
Westmoreland Road
Bromley
Kent BR1 1DP
Tel: 0800 158 2493

12.6 Trade Association

NCC

Catherine House,
Victoria Road,
Aldershot,
Hampshire, GU11 1SS
Tel: 01252 318251
www.thencc.org.uk
www.motorhomeinfo.co.uk e-mail: info@thencc.org.uk

12.7 Index

A

Acrylic (Plastic) Window Cleaning	111
Acrylic (Plastic) Window Condensation	111
Acrylic Windows	111
Additional security	34
Annual service/inspection record	11
Appliances	109, 110
Arrivals	14
Awnings and Tents	14, 36
Awning Spaces LPG Appliance Exhaust	49

B

Base Vehicle Warranty	6
Butane	48

C

CAN F05010 Oven (Ascari)	87
Cassette C260S	96
Change of Ownership	8
Choosing/Buying	21
Conditions for the SuperSure and Body Shell Warranties	6
Conventional Load	18
Cylinder compartment	47

D

Departure	15
Dogs and other Pets	14
Driving	15

E

Environment	16
Essential Habitation	19
Exterior (Body / Chassis)	109
External 12v Fill Socket	40
External Shower Point	106

F

Facts about LPG	49
Fastening the seat belt	23
Fire Precautions	14
Flue installations	50
Fresh Water Tank	40

G

Gas Cylinders	47
Gas Hoses	47
Gas safety advice	48
Gross Train Weight	19

H

Height-based seats	21
How can you prevent condensation	112

I

In case of fire	32
Interior (Furniture / furnishings)	110
ISOFix Child Seat Restraint	22

L

Levelling the motorhome	36
-------------------------	----

M

Mass in Running Order	18
Maximum Technically Permissible Laden Mass	19
Maximum Technically Permissible Laden Mass	19
Maximum User Payload	18
Mini and Micro Heki rooflight	97
Motorhomes with external BBQ point	106

N

Noise	14
Nose weight on towed trailers	19
Notification of change of ownership	134

O

On arrival at the campsite	53
On departure from the campsite	53
Operating instructions for blinds	97
Optional Equipment	19
Oven	87

P

Paintwork	111
Panel Van Conversion Body Shell Warranty	6
Parking	15
Personal Effects	18

Plumbing	108
Positioning/Fitting	21
Pressure switch adjustment	41
Principle	42
Propane	48

R

Recomissioning the Water System	110
Releasing the seat belt	23
Removing Tar	111
Roof lights	97

S

Seat belts and legislation	21
Selecting a pitch	36
Sensor cleaning	42
Servicing	108
SuperSure Warranty	6

T

To operate the Blind	97
TV Brackets	106

U

Use of Site Appliances	14
------------------------------	----

V

Vehicle Movement	14
VIN CHIP identification	34
VIN (Vehicle identification Number)	34

W

Waste Disposal	14
Waste water system	39
Weight-based seats	21
What is condensation	112
What to do if you Require Assistance	8
Wheels and Tyres	110
When condensation occurs	112
Where condensation occurs	112
Why condensation occurs	112

12.8 Change of ownership

Notification of change of ownership

As the new second hand owner, please notify the Swift Group of the change of ownership by emailing your details to:

enquiries@swiftleisure.co.uk.

Please provide a telephone number, date of purchase and a copy of your V5 document.

We will confirm that your records have been updated via an email and you will be invited to join the "My Swift Life" portal, which will enable you to access your vehicle details.

Alternatively you can complete the form below and send the completed form with a copy of your V5 to the following address:

Customer Services
Swift Group Limited, Dunswell Road,
Cottingham,
East Yorkshire HU16 4JX.

Note: Warranties are only transferable providing the terms and conditions of the warranty have been met by the previous owner(s). Please see warranty information at the beginning of this handbook for full details. The 'Extended Body shell warranty' is a non-transferable warranty.

Details of motorhome:	Model:	
	Chassis No:	
New owner:	Name:	
	Address:	
	Email:	
	Telephone:	
	Mobile:	
	Date of purchase:	
Previous Name: owner:	Name:	
	Address:	
	Email:	
	Telephone:	
	Mobile:	
	Date of purchase:	



SWIFT

SWIFT GROUP

Dunswell Road

Cottingham

East Yorkshire

HU16 4JX

Tel: 01482 875740

Fax: 01482 840082

Customer Experience Team

enquiries@swiftleisure.co.uk

FIND OUT MORE AT **SWIFTGROUP.CO.UK**