



SWIFT

SWIFT GROUP OWNER'S HANDBOOK

COACHBUILT MOTORHOMES

Issued September 2023

Part No. 1449664

The Active leisure range... long life batteries for life long memories



SWIFT
VALUE ADDED PARTNER



Whether you camp with full electric hook-up or use no mains supply, YBX Active batteries give you the freedom to go anywhere.

Recommended by Swift, Yuasa YBX Active Leisure & Marine batteries are specially designed to provide dependable, stress-free power & long life.

Power your getaway at
www.yuasa.com

YUASA  **BATTERY**

by **GS YUASA**

The only Swift Partner for Paint and Upholstery Protection



Diamondbrite
LEISURE



Paint Protection



Upholstery and Carpet Protection

The only
one with the
Lifetime
Guarantee

From the Makers of Diamondbrite Diamondbrite Leisure

*The ultimate Paint and Upholstery Protection
for your Swift Motorhome*

Diamondbrite Leisure is a two-step protection system for
your Swift Motorhome with a Lifetime Guarantee*

1. EXTERIOR

- Nano-Ceramic Technology
- Fade Resistant
- Never Polish Again!

2. INTERIOR

- Easy to Clean
- Stain Resistant
- Lifetime Guarantee

HOW DOES IT WORK?

1 If your paintwork was magnified it would reveal small pores in the surface.

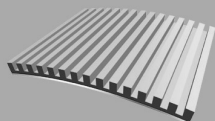

2 Road traffic dirt gathers in the pores and attacks paintwork.

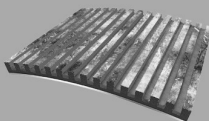

3 Your first Paint Protection application cleanses and fills pores in the vehicles paintwork leaving a smooth finish that cannot be penetrated.

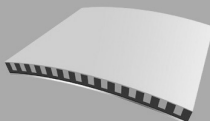

4 Your second application bonds with the first to create a hard protective skin. It leaves a high lustre finish that rain and dirt cannot penetrate.

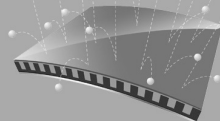

You will also receive a complimentary After Care pack including the fabulous Waterless Wash, plus a range of other professional cleaning products.

Jewelutra Ltd. Diamondbrite House, Ewell Lane,
West Farleigh, MAIDSTONE. ME15 ONG.

Tel **01622 815679**

Email diamondbrite@jewelutra.com

www.jewelutra.com



*Lifetime Guarantee applies for the length of time that the purchaser owns the vehicle and is non-transferable.



Diamondbrite
LEISURE

Refreshed. Relaxed. Recovered.



Stay cool with our
Truma Aventa air
conditioning range for
more comfort

www.trumauk.com/aventa



heating | cooling | controlling



More comfort on the move



Rear Wall-mounted Bike Rack

➤ **Thule Elite G2**

The perfect all-round bike rack



Extra strong aluminium guarantees stability and reliability.

Bike holders -

Adjustable soft-touch bike holders can easily be repositioned to align with the bike frame.

Sliding rails - The rails are adjustable from left to right. They easily slide to make sure you find the best position for your bikes without effort.

Lockable platform - The platform lock creates excellent dynamic force control and perfectly secures the bikes during transport. The platform is locked manually and can easily be clicked in the upwards position when not in use.

Wheel holders -

Finding the perfect position for your bike is easy thanks to adjustable wheel holders. They enable you to transport all kinds of bikes with various sizes.



- 2 versions: Standard and Short
- 2 bikes, extendable to 3 or 4
- Weight: 10.1kg
- Max. loading weight: 60kg
- Max. bike weight: 30kg
- Max. bike weight 4th rail: 15kg
- Suitable for e-bikes

A SUCCESS ON
DRAGONS'
DEN

luxury
Comfort
ON THE MOVE

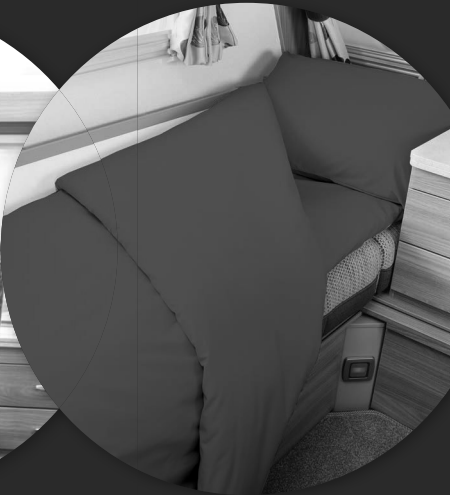

Duvalay are true pioneers – inventing the world's lightest bespoke caravan mattress, as well as innovative sleeping bags and portable toppers which have sold to more than one million customers globally.

To experience affordable bedtime luxury in every place you call 'home', choose Duvalay.

duvalayTM
BEDTIME LUXURY

Order online or by phone
duvalay.co.uk
01274 877 200



Dear owner

Thank you for deciding to buy one of our new motorhomes.

We are sure you will enjoy many happy hours in it and we hope the information and hints in this handbook will heighten your enjoyment.

The handbook has been designed to give you a general guide to the care, use and maintenance of your motorhome. Whether you are a new or an experienced motorhomer the hints will help to protect your investment.

The information contained will answer most of your queries, but if there are any aspects which are not covered please consult your appointed dealer. We would suggest you make a note of your dealers name and contact information below.

Throughout the season, specifications and equipment details contained within this handbook may change. Please refer to our online handbooks (www.swiftgroup.co.uk) for the most up-to-date version of your handbook.

Customers should note that this handbook, contains general information for the use and care of your product and the technical handbook contains the technical information, weights and dimensions of all products.

Dealer Name:

.....

Sales Tel:

.....

Telephone Number:

.....

Service Centre Tel:

.....

E-mail:

.....

Parts Tel:

.....

VIN:

.....

First Service Due:

.....

Contents

1. Warranty	5
2. Motorhome Code	15
3. Preparing for the road	19
4. En Route	31
5. Safety and Security	39
6. Arrival at the site	45
7. Services	47
8. Electrics	69
9. Fitted Equipment	143
10. Maintenance	183
11. Useful Information	193
Index	196

1. Warranty

1.1 Motorhome Warranty	6
1.2 Change of ownership	9
1.3 My Swift Life	9
1.4 What to do if you require assistance	9
1.5 Annual service/ inspection record	10
1.6 Annual service / inspection record stamps	11
1.7 Supplier contacts	13

1.1 Motorhome Warranty

All the illustrations and descriptive matter in this handbook are intended to give a general idea of the motorhome. Changing market and supply situations and our policy of continuous product development may prevent us from maintaining the exact specifications detailed in this handbook. We therefore reserve the right to alter specifications as materials and conditions demand.

Dealers are not agents of Swift Group Limited ("Swift") and have absolutely no authority to bind the manufacturer by any express or implied undertaking or representation.

Your Coach-built motorhome has four warranties:

Base Vehicle Warranty – provided by Ford or Fiat

Your vehicle is a coach-built motorhome which utilises a Ford or Fiat base vehicle. Swift takes a flat bed chassis supplied by Ford or Fiat and adds the coach-built habitation part of the motorhome. Ford or Fiat provide a manufacturer's warranty for the base vehicle as supplied to Swift by them. For any issues with the base vehicle warranty please contact your local Ford or Fiat dealer. This Motorhome Warranty does not cover any parts of your motorhome that are covered by the Ford or Fiat manufacturer's warranty. Your base vehicle warranty is subject to the terms and conditions contained in the Ford or Fiat handbook supplied with the base vehicle and the vehicle must be serviced in accordance with Ford's or Fiat's requirements.

SuperSure Warranty – provided by Swift

For all parts or fittings of your coach-built motorhome other than the habitation body shell and the Ford or Fiat base vehicle, Swift will repair (or at its option, replace) any defective parts or fittings for 3 years from the original date of purchase (or hire purchase) subject to conditions, terms and exclusions below.

Body Shell Warranty – provided by Swift

Swift will repair (or at its option, replace) any defects with the habitation body shell for 6 years from the original date of purchase (or hire purchase), subject to the conditions, terms and exclusions below.

Extended Body Shell Warranty – provided by Swift

For the first owner, Swift will repair (or at its option, replace) any defects with the habitation body shell for 10 years from the date of purchase (or hire purchase), subject to the conditions, terms and exclusions below. The SuperSure Warranty, the Body Shell warranty and/or the Extended Body Shell Warranty provided by Swift do not cover any parts of the motorhome that are covered by the Ford or Fiat warranty.

Conditions for the SuperSure, Body Shell and Extended Body Shell Warranties

1. You must ensure that the habitation part of your coach-built motorhome has an Annual Service (see clause 2 below) within 90 days before or 60 days after each anniversary of the original date of purchase. In order to preserve your SuperSure Warranty the third Annual Service must, however, be carried out before the expiry of the 36 month period from the original date of purchase. In order to preserve your Body Shell Warranty, the sixth Annual Service must be carried out before the expiry of the 72 month period from the original date of purchase. In order to preserve your Extended Body Shell Warranty, the tenth Annual Service must be carried out before the expiry of the 120 month period from the original date of purchase. If you have not performed an Annual Service then Swift will not be obliged to perform any work under the applicable warranty. Original VAT invoices must be retained as proof that Annual Service have been carried out.
2. The Annual Service on the body shell and habitation area must be carried out in accordance with the requirements in this handbook. You will be responsible for any charges made for an Annual Service. If the Annual Service is performed by an authorised Swift Group Service Centre then Swift warrants that the Annual Service has been performed correctly. If the Annual Service is performed by an unauthorised repairer or service centre then if the Annual Service has not been performed in accordance with the requirements in this handbook and/or work has been performed on your motorhome that is defective or faulty, then Swift will not be obliged to perform any work under this Warranty (insofar as it relates to defective or faulty work or defective Annual Service).

3. All new motorhomes must be registered with Swift within 6 weeks of purchase as new.
4. The benefit of the SuperSure and Body Shell Warranties may be transferred to a new owner if the motorhome is re-sold, provided that the motorhome has been serviced in accordance with the requirements of this handbook, and details of the change of ownership have been supplied to Swift using the change of ownership form set out in this handbook as soon as reasonably practicable after the change.
5. The benefit of the Extended Body Shell Warranty is non transferable to new owners and applies only to the original registered keeper of the vehicle.
6. If any repairs are identified as being necessary to the body shell or habitation areas during an Annual Service or otherwise, Swift will only pay for Warranty work performed by an authorised Swift Group Service Centre. The motorhome must be made available to an authorised Swift Group Service Centre within 6 weeks of the date the repair need was identified for the work to be carried out. The cost of transporting, towing or moving the motorhome by any means to or from the place of repair is the responsibility of the owner.
7. The SuperSure, Body Shell and Extended Body Shell Warranties only apply to motorhomes purchased and used primarily within the UK. Please refer to the Fiat handbook .

Terms

8. The Body Shell Warranty and Extended Body Shell Warranty covers any defect with the panels and seams of the coachbuilt habitation part of the motorhome. This includes body leaks, delamination of panels or floor, water ingress through any permanently sealed seam joints. **NB: The Extended Body Shell Warranty is non transferable and only applies to the original registered owner.**
9. In the first 12 months the SuperSure Warranty will cover any defect other than those specified in the Exclusions below.
10. In the years 2 and 3 the SuperSure Warranty will only cover any defect with the following components:
 - **Electrical System:** PSU, battery charger, Smart Command and interior lighting units (excluding bulbs)..
 - **Water system:** water heater, fresh water tank, water pump, water gauges, taps and shower head.
 - **Cooker:** the cooker unit including grill, oven, burners, igniter and flame failure device.
 - **Refrigerator:** gas igniter, flame failure device, door seal condenser, gas control valve, 12V and 230V heater elements, gas thermostat, 230V thermostat and 230V temperature control switch.
 - **Cassette toilet:** the cassette toilet (excluding seals, valves and glands)
 - **Heating system:** thermostat, motor, switches, control unit, gas heater, flame failure device and igniter (excluding ducting and fittings)
 - **Windows:** the functionality of the opening and closing system (stays, handles and catches) and a warranty against the cracking of the acrylic. Excludes fading.
 - **Upholstery:** zips, seams and colour fastness.

In years 2 and 3, any defect specified in the Exclusions will not be covered.

11. Swift shall not be liable under the SuperSure, Body Shell and Extended Body Shell Warranties for any defect related to or arising from the following:

- The failure of a component for reasons of fair wear and tear;
- Damage resulting from freezing, fire, overheating or accidents (whether caused by the user or a third party);
- Misuse of any component;
- Normal deterioration, corrosion, intrusion of foreign or harmful bodies, lack of servicing or negligence of any person other than Swift
- which causes stoppage of or impairment to the function of any component of the motorhome;
- Replacement of parts which have reached the end of their effective working life because of age and/or usage; Cleaning or adjustment of any assemblies;
- Cosmetic finishes to kitchen sinks, cooker tops, vanity units, shower trays; and/or
- Routine maintenance items which are part of the annual service including lubricants, rubber gas hose, the cleaning of the heater and fridge flues, the replacement of gas jets, the resealing and/or replacement of shower room sealant, and the adjustment and lubrication of locks.
- Damage caused by any abrasive cleaners

12. In addition to the exclusions above, in years 2 and 3 of the SuperSure Warranty Period, Swift Group Limited shall not be liable under this Warranty for any defects related to:

- Any audio equipment
- Any microwave
- Wall and Roof GRP sheeting material: after 24 months from date of purchase
- Plastofom window system (Edge, Ascari, Voyager, Escape): after 24 months from date of purchase
- Factory fitted leisure battery: after 12 months from date of purchase
- Factory fitted Thule awning (where fitted): after 24 months from date of purchase

13. Swift shall also not be liable under the SuperSure, Body Shell and Extended Body Shell Warranties if the Motorhome has been neglected, misused, modified or used for hire or reward or if the identification marks (chassis/VIN numbers) have been removed or defaced. The motorhome will be deemed to have been neglected if it has not been serviced and maintained as stated in this handbook or any repairs being identified as necessary at an Annual Service or by a Swift Group Service Centre have not been carried out in a reasonable time.

You have legal rights under UK law governing the sale of consumer goods. This Warranty does not affect your legal rights.

The name and address of the Warranty provider is:

Swift Group Limited, Dunswell Road, Cottingham, East Yorkshire, HU16 4JX

To make a claim under this Warranty, contact the Swift Group Dealer which supplied your motorhome. Alternatively, details of your nearest authorised Swift Group Service Centre can be found on our website, however please note that only your supplying dealer is obliged to carry out warranty work. Alternatively you can contact the Swift Group via the Swift Customer Portal "My Swift Life", please visit our website to register: www.swiftgroup.co.uk

1.2 Change of ownership

You can transfer the remainder of any 3 year 'Supersure' warranty' and the 6 year 'Body Shell' warranty, details of how to do this can be found at the rear of this handbook. The 'Extended 10 Year Body Shell Warranty' is non transferable.

1.3 My Swift Life

You have access to an online system which is for all Swift models. Please register via our website www.swiftgroup.co.uk

Once registered please log in and create your own profile. Should you have issues with accessing My Swift Life, please contact our Customer Experience Team, via email: enquiries@swiftleisure.co.uk

Note: You will need to inform Ford or Fiat UK of any change of ownership relating to the base vehicle warranty.

1.4 What to do if you require assistance

Should you have an enquiry or require assistance with a problem, we hope that this guide will be of assistance to you.

Please follow these steps:

1. Check the Owners Handbook, paying particular attention to the fault finding advice at the back of the book.
2. Contact your supplying dealer for assistance.

If you need to contact the Swift Group, please be aware of the following:

1. The best way to contact the Swift Customer Experience team is via the My Swift Life portal, if you are contacting us via, email or phone please quote your name, postcode and VIN (Vehicle Identification Number). This can be found at the bottom of the front windscreen, on the plate on the front cross member within the engine compartment (Fiat) or on the inside of the door pillar (Ford). The Swift manufacturers plate also contains the VIN and is situated on the inside of the passenger door pillar.
2. In most instances, the Customer Experience Team will involve your dealer in resolving the issue you are experiencing and will be in touch within 5 working days..
3. Please be aware that the Swift Group cannot send parts direct from the factory. In all cases, without exception, your dealer must place the order for you and if your dealer quotes your chassis number, this will enable you to view your order in the My Swift Life portal.

1.5 Annual service/ inspection record

In order to comply with the warranty, you must have the habitation area of your motorhome inspected and serviced at least once per year.

Note: The base vehicle servicing requirements are found in the Ford or Fiat handbooks.

We highly recommend that you have your Motorhome serviced by a Swift Group Approved Service Centre who have direct access to our online Customer Service system, Connect. This system provides them with the ability to order approved parts and ensure that any product upgrades which may be available for your Motorhome can be offered to you and carried out as part of the service. In the unfortunate event that an issue requires attention under warranty then Swift Group Approved Service Centres are able to submit a warranty claim to the Swift Group for processing, and deal with the issue for you from start to finish. All of our Swift Group Approved Service Centres are provided with up to date technical information and have access to current repair methods giving you peace of mind that any defect has been repaired effectively.

It is important that the Owner's Handbook is stamped on the appropriate page by the authorised Swift Group Service Centre. Failure to do this will invalidate the warranty and the transfer of the warranty on the change of ownership.

The inspection should take approximately two to four hours and will cover the areas dealt with in the annual service check list. Any areas requiring service and/or maintenance will be highlighted by your dealer and we recommend that you authorise any necessary work to be carried out.

Note: It is essential, to validate the warranty, that an annual inspection be carried out by an authorised Swift Group Service Centre covering the items listed.

1. Damp and lamination test
2. Chassis and chassis to body security
3. Motorhome step
4. Road lights, wiring and reflectors
5. Internal lights and 12V DC system
6. Water heater - gas and 230V AC (if fitted)
7. Hob, grill and oven
8. Refrigerator 230V AC, 12V DC and gas
9. Gas system
10. Water pump, taps and water system
11. Mains 230V AC system
12. Windows and fittings
13. Smoke alarm and battery
14. Carbon Monoxide detector and Battery
15. Roof lights
16. Furniture hinges/stays etc
17. Exterior locks and hinges
18. All internal vents
19. Seals
20. Blinds and fly screens (if fitted)
21. Blown air heating and gas fire systems
22. Drop down bed operation

<p>1.6 Annual service / inspection record stamps</p> <p>Motorhome model:</p> <p>Year:</p> <p>Chassis VIN:</p>	<p>1st service</p> <p>DATE:</p> <p>DEALER'S STAMP</p> <p>We certify that an annual service has been carried out in accordance with the handbook.</p>
<p>2nd service</p> <p>DATE:</p> <p>DEALER'S STAMP</p> <p>We certify that an annual service has been carried out in accordance with the handbook.</p>	<p>3rd service</p> <p>DATE:</p> <p>DEALER'S STAMP</p> <p>We certify that an annual service has been carried out in accordance with the handbook.</p>
<p>4th service</p> <p>DATE:</p> <p>DEALER'S STAMP</p> <p>We certify that an annual service has been carried out in accordance with the handbook.</p>	<p>5th service</p> <p>DATE:</p> <p>DEALER'S STAMP</p> <p>We certify that an annual service has been carried out in accordance with the handbook.</p>
<p>6th service</p> <p>DATE:</p> <p>DEALER'S STAMP</p> <p>We certify that an annual service has been carried out in accordance with the handbook.</p>	<p>7th service</p> <p>DATE:</p> <p>DEALER'S STAMP</p> <p>We certify that an annual service has been carried out in accordance with the handbook.</p>

<p>8th service DATE: DEALER'S STAMP</p> <p>We certify that an annual service has been carried out in accordance with the handbook.</p>	<p>9th service DATE: DEALER'S STAMP</p> <p>We certify that an annual service has been carried out in accordance with the handbook.</p>
<p>10th service DATE: DEALER'S STAMP</p> <p>We certify that an annual service has been carried out in accordance with the handbook.</p>	<p>11th service DATE: DEALER'S STAMP</p> <p>We certify that an annual service has been carried out in accordance with the handbook.</p>

1.7 Supplier contacts

A number of Swift Group suppliers manage their own Technical and Warranty related queries. Where a customer has a question relating to a product manufactured by a company listed below, we would advise that the first contact should be directly with them.



Sargent Electrical Services

Unit 39, Tokenspire Business Park, Beverley,
East Yorkshire, HU17 0TB
Phone: 01482 678981
Fax: 01482 678987
E-mail: support@sargentltd.co.uk

<https://sargentltd.co.uk>



AL-KO Kober Limited

South Warwickshire Business Park
Kineton Road, Southam,
Warwickshire, CV47 0AL
Fax: 01926 818562
Email: mail@al-ko.co.uk

<http://www.al-ko.co.uk>



Truma UK Ltd.

Park lane, Dove Valley Park,
South Derbyshire, DE65 5BG
Phone: 01283 586020
Fax: 01283 586029
technical@trumauk.com

<https://www.truma.com/uk/en/home>



Thetford Ltd.

Unit 6, Brookfields Way, Manvers,
Dearne Valley, Rotherham,
South Yorkshire, S63 5DL
Phone - 0844 997 1960
Fax - 0844 997 1961
Email - infogb@thetford.eu

<https://www.thetford-europe.com>



Alde International (UK) Ltd

Huxley Close, Park Farm South,
Wellingborough, Northants, NN8 6AB
Phone: 01933 677765
Fax: 01933 674975
Email: info@alde.co.uk

<https://www.alde.co.uk/>



Dometic (UK) Ltd

Dometic House, The Brewery,
Blandford St Mary, Dorset, DT11 9LS
Phone: 0844 626 0133
Email: technical@dometic.co.uk

<https://www.dometic.com/en-gb/uk>



2. Motorhome Code

2.1 Code of conduct	16
2.2 Wild camping	17
2.3 Environment	17
2.4 The Country Code	17
2.5 Coastal code	18
2.6 Handbooks (chassis & converter)	18

2.1 Code of conduct

Camp sites

Arrivals

Report to reception immediately on arrival.

Vehicle Movement

Keep to roadways unless otherwise directed. Adhere to speed limits. Note that these are generally 10 mph. (Remember that the stopping distance on grass is considerably greater than on tarmac.)

Only a person in possession of a current driving licence may drive on the site.

Park correctly as advised on your pitch. Where possible leave 20 feet of free space around your vehicle.

Use of Site Appliances

Use the electrical mains hook-up in the correct manner and with caution. Ensure that all fresh water taps/connections are turned off after use. Have care and consideration when using all facilities (toilets and showers etc) and leave clean and tidy. Young children should be supervised.

Waste Disposal

If the vehicle is not fitted with a waste water tank, a suitable receptacle should be placed below all waste water outlet pipes. Do not let these containers overflow. Dispose of all waste water where instructed. Empty effluent from chemical toilets where instructed.

To avoid possible damage to sewage purification works, only approved chemical fluids must be used. Under no circumstances should coal tar, phenol or caustic-based fluids be used.

Disposable nappies and similar bulky items must not be put into chemical closet emptying points but should be wrapped in a polythene bag and placed in the container provided. Place all litter in containers marked for the purpose.

Noise

Do not make excessive noise.

Children should be restrained from making excessive noise.

Flying kites and model aircraft/drones and the use of items like catapults or air-guns, as well as ball games, should not be permitted among, or close to other vehicles.

Musical instruments, record players, radios and televisions should not be used to the inconvenience of other people on the site.

Open and close doors quietly.

Power generators must be adequately silenced and used with consideration.

Dogs and other Pets

All dogs and other pets should be kept under control. Unless permission has been granted, no animal should be allowed loose on the site and leads must not exceed 10ft.

No animals should be allowed in the shower/toilet blocks.

Do not let dogs foul the site.

Fire Precautions

Adhere to and take note of fire precautions noting the whereabouts of the fire points.

⚠ WARNING: Provide one dry powder fire extinguisher of an approved type or complying with EN3-7 or ISO 7165, of at least 1kg capacity, by the main exterior door and a fire blanket next to the cooker. Familiarise yourself with the operating instructions on your fire extinguisher and the local fire precaution arrangements.

When using a dry powder extinguisher it is suggested that the motorhome be evacuated until the powder has settled, to avoid inhalation.

Unless permission has been granted, barbecues should not be used. If permission is given, consideration should be given to the annoyance that can be caused to other users of the site.

Open fires are not allowed.

Awnings and Tents

Awnings and tents should only be used when permission has been obtained. When on grass and staying for more than a few days, the ground sheet and/or side flaps of awnings should be periodically raised in order to avoid damage to the ground.

Departure

Leave the pitch clean and tidy.

On leaving, check out with reception paying the required fees.

2.2 Wild camping

Camping away from licensed sites, without the permission from the land owner or his agents, is not allowed in the United Kingdom.

When permission has been granted, all aspects of this Code should be adhered to.

On no account should:

- Litter be disposed of other than in the receptacles provided.
- Water be allowed to escape from the vehicle.
- Chemical toilets be emptied except into the disposal places agreed with the land owner.
- Washing or similar be hung outside the vehicle.

Parking

Motorhomes should only be parked in approved places.

When using the facilities of a motorhome, care and consideration should be given to those around them.

Driving

Before moving off, elevated rooflights and aerials should be lowered and correctly secured, and top hinged windows closed. Likewise all doors and access lockers for gas containers and chemical toilets must be properly secured.

Exterior steps should be properly retracted and secured. When the vehicle is in motion it is compulsory for all front seat passengers and rear seat passengers to wear seat belts, where fitted.

When using a motorhome on either the public highway or private roads the Highway Code should be complied with and full consideration given to other road users. In the event of a motorhome travelling slowly the driver of the motorhome should, where possible, pull over in order to let other traffic pass.

⚠ WARNING: When refuelling or on a ferry ensure the gas system is fully isolated at source.

2.3 Environment

Care and consideration should be taken to protect the environment. Observe the Country and Coastal Codes.

2.4 The Country Code

Enjoy the countryside but respect its life and work.

More people than ever before are exploring the countryside, interested in farming, plant life, bird watching or just observing the general wildlife. Whatever your interest, there is a lot to learn, but please observe the following code:

1. Guard against all risk of fires. Hay and heathland catch alight easily and once ablaze are very difficult to put out.
Remember: fire spreads quickly.
2. Fasten all gates.
3. Keep your dog under proper control.
4. Keep to the paths across farm land.
5. Avoid damaging fences, hedges and walls.
6. Leave no litter.
7. Safeguard water supplies.
8. Protect wildlife, wild plants and trees.
9. Go carefully on country roads.
10. Respect the life of the countryside. The

2.5 Coastal code

As our coastlines are increasingly used for recreation and education, the following suggestions are made to enable us to enjoy our inheritance and preserve it for posterity.

Disturbance may mean DEATH.

Do not trample about, or move rocks unnecessarily.

Do not frighten seals or seabirds.

Do not spill detergents, solvents or fuel from boats as these can kill marine life.

When sailing, moderate your speed - the wash from a fast boat can destroy banks and nests.

Live molluscs and crustaceans need not be collected as souvenirs - dead shells can usually be found.

Shellfish can take years to grow and fines can be imposed for not observing national regulations.

Do not pull up seaweeds unnecessarily. Make your visit instructive - not destructive.

Look at material - don't remove it. Take notes and photographs, not specimens.

Observe by-laws and be considerate to others.

National Trust property and Country Parks have regulations to protect the wildlife. Follow these and the Country and Coastal Codes.

2.6 Handbooks (chassis & converter)

Before using a motorhome all aspects of the handbooks, produced by the chassis manufacturer and the converter, must be read and adhered to.

The separate chassis manufacturer handbook refers to your motorhome chassis and base vehicle including care and maintenance.

Fiat handbook



<https://bit.ly/30UP7vT>

Ford handbook



<https://bit.ly/3JpAkrN>

If you are unable to view the documents on line, please contact the supplier, your dealer or Swift for an electronic or paper copy.

3. Preparing for the road

3.1 Before moving off	20
3.2 Motorhome terms	20
3.3 Loading of vehicle	21
3.4 Large storage areas	22
3.5 Roof loading	22
3.6 Tyres	22
3.7 Tyre Pressures	23
3.8 Dedicated travelling passenger seating	23
3.9 Child seats	23
3.10 ISOFix Child Seat Restraint	25
3.11 Three point seat belts	27
3.12 Driving licence	28
3.13 Advice on towing	28
3.14 European Touring	29

3.1 Before moving off

Check:

- Gas cylinders are correctly positioned, secured and turned off unless using en-route
- Heating. all gas operated appliances have been isolated, except the en-route heating system if fitted.
- Loose articles including bed and luton ladders are stowed securely. Do not stow tins, bottles or heavy items in overhead lockers.
- All lockers and cupboard doors are closed and secured.
- Tables are stored or locked in their transit position.
- Fridge is on 12V operation and door lock s set.
- 230V mains input socket flap is securely closed.
- All drain valves are closed
- Tyre pressures and wheel nuts.
- Rear corner steadies (if fitted) are raised.
- Exterior roof rack ladder is raised and secured.
- All windows/doors/rooflights are closed and secured.
- TV aerial is lowered and locked into position (where fitted).
- Exterior step (where fitted) is retracted / folded in.
- Ensure exterior service locker is closed and locked (where fitted).
- Drop down bed is in upper stowed position.

Special attention must be taken to ensure all top hinged windows as well as the Luton windows, Skyviews and rooflights are closed when in transit. All units should be fully closed and latched to prevent damage. The motorhome exterior door should also be locked.

⚠ WARNING: Large and/or voluminous items should be stored securely before travelling.

⚠ WARNING: Vehicles over 3m high have a maximum vehicle height label affixed to the drivers sunblind. When planning your route take your vehicle height into consideration.

Central locking (if fitted)

Central locking features vary between type of base vehicle (Fiat or Ford), base vehicle manufacturer changes and updates, and in some cases adjustable settings on the base

vehicle dashboard. In addition, the presence of a central locking link from the base vehicle to the habitation door is dependent on range and model.

The base vehicle central locking typically will not activate unless the cab doors are closed, and depending on base vehicle the habitation door may also need to be closed. Care is needed to understand the central locking features on your motorhome, to prevent being locked out, for instance:

It is possible that after un-locking doors using the supplied keyfob, if no door is opened, or if only the habitation door is opened, the central locking may automatically re-lock after a short period of time.

If a habitation door is open when central locking is activated, the habitation door lock when that door is closed may engage and become locked.

To open the habitation door from inside the motorhome when locked, pull the internal door handle twice.

3.2 Motorhome terms

Mass in Running Order:

The mass of the motorhome equipped to the motorhome manufacturers standard specification, as stated by the manufacturer.

The MRO comprises the ex-works weight of the motorhome, including the driver, 90% fuel capacity, 1 x LPG gas cylinder @10kg and standard fixtures & fittings in compliance with European Regulation No. 1230/2012 (Masses & Dimensions)

ⓘ Note: The mass of the motorhome in running order contains provision for the masses of liquids, gas etc. (see Mass in Running Order in the Technical Section). Part of this provision can also be utilised as additional payload, if for example, you wish to travel with no gas cylinders.

ⓘ Note: If you travel with water in the fresh water tank or waste tank, the payload will be reduced accordingly

ⓘ Note: Quoted MRO is subject to tolerance, due to weight variation of materials used in Motorhome construction.

Maximum User Payload:

The maximum allowable weight to be put into the motorhome whilst it is being driven. This is made up of 4 sections:

Personal effects, conventional load, optional equipment and essential habitation equipment.

The Maximum User Payload is the difference between the Maximum Technically Permissible Laden Mass and the Mass in Running Order.

Personal Effects:

Those items which a user can choose to carry in a motorhome and which are not included as Essential Habitation Equipment or Optional equipment.

Conventional Load:

A mass allowance for each designated passenger seat.

Optional Equipment:

Items made available by the manufacturer over and above the standard specification of the motorhome.

Essential Habitation:

A mass allowance for liquids in systems not accounted for within the MRO.

Maximum Technically Permissible Laden Mass:

The maximum weight for which the motorhome is designed for normal use when being driven on a road, laden.

This mass takes into account specific operating conditions including factors such as the strength of materials, loading capacity of tyres etc.

⚠ WARNING: Under no circumstances should the axle loadings or the Maximum Technically Permissible Laden Mass of the motorhome be exceeded.

Nose weight of Towed Trailers:

The static mass of the trailer towing device on the rear of the towing vehicle.

Notes:

When measuring the noseweight it is important that the trailer is loaded.

The trailer is intended to be towed slightly nose heavy. The nose weight can be adjusted by distribution of the load. The nose weight should be approximately 7% of the actual laden weight (but not greater than the hitch capacity) and at the same time suit the motorhome requirements.

See 'Advice on Towing'

3.3 Loading of vehicle

⚠ WARNING: The driver is responsible for arranging the loads so that they comply with the technical weight limits of the specific motorhome model.

Correct weight distribution is an important factor in ensuring your vehicle is well balanced and easy to drive. It is therefore necessary to load your motorhome carefully making sure all heavy articles are evenly distributed and are preferably placed in the lower lockers or bed boxes.

⚠ WARNING: Do not travel with televisions or microwaves in overhead lockers unless the appliance was supplied fitted to your motorhome by the manufacturer.

Although it is essential to ensure that the total weight of your motorhome does not exceed the stipulated Maximum Technically Permissible Laden Mass, (MTPLM), it is important to remember that the front and rear axles also have individual maximum weights which must not be exceeded.

See your Technical Handbook for MTPLM and maximum axle loads.

Note: To ensure adequate road holding the load on the front axle, under all conditions, must not be less than 40% or more than 70% of the total weight.

Ensure you distribute the payload equally on each side of the vehicle to avoid an imbalance. These weights, together with the MTPLM, can be found on the Statutory plate adhered to the bulkhead behind the right hand cab seat.

Note: Please take care to ensure you have allowed for the masses of all the items you intend to carry in your motorhome e.g. passengers, optional equipment, essential habitational equipment and personal effects such as clothing, food, pets, bicycles, sailboards, sports equipment etc.

3.4 Large storage areas

The large storage areas provided in some motorhome layouts are designed solely for the purpose of carrying personal possessions, these areas must not be used;

- as a habitation area (eg living, sleeping or cooking).
- to carry passengers, animals or livestock.
- for the installation (or use) of any LPG gas operated appliances, (unless supplied fitted by the manufacturer).
- for carrying LPG gas bottle cylinders.
- to carry any flammable liquids, unless properly stored, sealed and secured.
- for the operation of an electrical generator.
- in such a way that the load exceeds the MTPLM or maximum axle loads.

Care must be taken to ensure that exterior doors are closed, locked and that all possessions are properly stored and secured before setting off on any journey.

3.5 Roof loading

Some motorhome roofs can be fitted with a roof rack (optional).

A maximum load of 50kgs can be evenly distributed on the roof rack system.

This figure **MUST NOT** be exceeded.

Note: When loading the roof rack, make sure the load is spread evenly and do not allow sharp objects to come into contact with the roof surface.

Note: Ensure items loaded on the roof rack do not act as a sail (i.e. deck chairs).

WARNING: Do not apply excessive load to the rear suspension of your motorhome or allow the vehicle to reverse with the roof rack access ladder in the down position, touching the ground. This may cause excessive strain on the ladder fixing points.

The flat roof areas, up to the over cab section, are capable of withstanding an average person's weight (13 stone or 82.5kg).

Note: Do not walk on the formed over cab roof section.

WARNING: The roof may become slippery in adverse conditions, wipe dry before attempting to walk on roof section. Extreme care should be taken to avoid falling from the vehicle.

WARNING: When walking on the roof, deck type shoes should be worn – not leather sole.

3.6 Tyres

Note: If a wheel or tyre fitted to a vehicle is changed any replacement must be of the same type of construction and size.

The law requires that the tyres and pressures must be suitable for the use to which they are being put. The minimum tread depth must be 1.6mm throughout a continuous band comprising the centre three-quarters of the breadth of the tread and around the circumference of the tyre.

Please refer to base vehicle manufacturer's handbook (Fiat/Ford or AL-KO AMC conversion handbook) for tyre pressure information.

This may also be displayed in the driver's or passenger's door aperture.

Fiat Based Motorhome Tyre Specifications

You should note Motorhomes using a Fiat base vehicle are fitted with "Camper Tyres". Camper tyres meet a specific "CP" (Camping Pneu) standard for tyres on Motorhomes. The Camper tyres on a Motorhome (unlike a commercial van) are designed to carry a significantly higher load for the majority of their life and even when stationary for greater periods of time unlike a van which typically loads and unloads. As a result Camper tyres have stiffened side walls to withstand the increased payloads and pressure on them, this extra reinforcement also gives better vehicle stability on the rear with the heavier rear axle loads typical on a Motorhome. The tyres are also designed to improve mileage (wear) and offer better grip off road.

When replacing your tyres we only recommend the fitment of CP or Camper Tyres.

3.7 Tyre Pressures

The motorhome tyre pressures noted in the Fiat/Ford handbook are the pressures stated by Fiat/Ford for your vehicle and are calculated in a fully laden condition. If you are not running fully laden, reduced pressures could be used but please seek clarification from the Tyre manufacturer.

3.8 Dedicated travelling passenger seating

Seat belts are fitted to all travelling seats. Travelling seats are designated by the manufacturer and vary according to the layout you have purchased. Each seat is homologated i.e. tested to all relevant safety requirements. NEVER travel in or attempt to install a seatbelt to a non-designated seat.

⚠ WARNING: Side facing seats are designed for habitational use only, not for use when the vehicle is in motion.

Seat belts and legislation

Designated driver and passenger seats are fitted with seat belts and MUST be worn when travelling.

Children, aged up to 3 years of age, must wear an appropriate child restraint suitable for their age and weight. Children from 3 years of age and up to 135cm (4'5") in height, or 12 years of age, whichever is reached first must use a child car seat or booster seat suitable for their age.

Children over 135cm (4'5") in height or aged 12 years and over must wear a seat belt.

📌 Note: It is the legal responsibility of the driver to ensure children aged up to 14 years old are suitably restrained. For passengers aged 14 and over, it is their responsibility (not the driver) that a seat belt is worn.

Seat belts are fitted for your safety and must be worn unless a 'Certificate of Exemption from Compulsory Seat Belt Wearing' is held. This Certificate must be produced if asked for by the Police – seat belt offences can result in a fine.

3.9 Child seats

Choosing/Buying

Go to a reputable retailer such as Halford's or John Lewis etc. Most reputable retailers will have trained child seat advisers on site and will offer a fitting service. Ask the advisor to fit various seats to the vehicle. Once a correctly fitting seat has been installed, satisfy yourself on its suitability for your child and the vehicle before buying as it is important to use a correctly fitting seat in your motorhome.

⚠ WARNING: The child seat you use in your car may not be suitable for mounting on a motorhome seat.

Choose the right seat for your child's height and weight.

Height-based seats

Height-based seats are known as 'i-Size' seats. They must be rear-facing until your child is over 15 months old. Your child can use a forward-facing child car seat when they're over 15 months old.

You must check the seat to make sure it's suitable for the height of your child.

Only EU-approved height-based child car seats can be used in the UK. These have a label showing a capital 'E' in a circle and 'R129'.

Weight-based seats

The seat your child can use (and the way they must be restrained in it) depends on their weight.

Only EU-approved weight-based child car seats can be used in the UK. These have a label showing a capital 'E' in a circle and 'ECE R44'.

You may be able to choose from more than one type of seat in the group for your child's weight.

For more information visit www.gov.uk

Never fit or use a second hand car seat. It could have been damaged and may not meet modern standards. The fitting instructions may also be missing.

Positioning/ Fitting

Dependant upon the child seat type, the most suitable position for the child seat to be fitted may be the front passenger seat of the cab (NOTE airbag advice below) or the window seat of the forward facing rear seat, advice should always be taken from the retailer on the suitability and security of the seat in the motorhome. The aisle seat is not recommended unless an ISOFIX point is present (Escape, Voyager or Kon-Tiki only).

Read and follow the child seat manufacturer's instructions for fitting the seat.

All Swift Motorhomes are fitted with inertia reel seat belts, however, the child seat must be tight in the adult seat. Push all your weight into the child seat as you tighten the belt.

Keep a copy of the child seat fitting instruction in the motorhome for easy reference.

Any doubts, ask an advisor to show you how to correctly install the seat.

Airbag

Never fit a rear-facing child restraint in a seat with an active airbag in front of it.

Forward-facing child restraints should be positioned as far back from the airbag as possible. Check the base vehicle handbook.

⚠️WARNING: Extreme Hazard! Never use a rearward facing child restraint on a seat protected by an active airbag in front of it. Death or serious injury to the child can occur.

⚠️WARNING: You must switch the passenger airbag off when using a rearward facing child restraint on the front seat.

⚠️WARNING: You must switch the passenger airbag on following the removal of the child restraint.

⚠️WARNING: Do not modify child restraints in any way.

⚠️WARNING: Do not hold a child on your lap when your vehicle is moving.

⚠️WARNING: Do not leave children or pets unattended in your vehicle. Failure to follow this instruction could result in personal injury or death.

⚠️WARNING: If your vehicle has been involved in a crash, have the child restraints checked.

⚠️WARNING: Do not put the shoulder section of the seatbelt or allow the child to put the shoulder section of the seatbelt under their arm or behind their back. Failure to follow this instruction could reduce the effectiveness of the seatbelt and increase the risk of injury or death in a crash.

⚠️WARNING: Do not use pillows, books or towels to boost your child's height. Failure to follow this instruction could result in personal injury or death.

⚠️WARNING: Always make sure your child is secured properly in a device that is appropriate for their height, age and weight. Child safety restraints must be bought separately from your vehicle. Failure to follow these instructions and guidelines may result in an increased risk of serious injury or death to your child.

3.10 ISOFix Child Seat Restraint

⚠️WARNING: Use a top tether anti-rotation device when using the ISOFIX system.

Do not use a child restraint with a support leg. Top tethers must be used.

⚠️WARNING: Only child restraints certified to ECE-R129 or ECE-R44.03 (or later) have been tested and approved for use in your motor home.

The Ascari, Escape, Voyager and Kon-Tiki models are fitted with ISOFIX anchor points that accommodate universally approved ISOFIX child seats. Top tether anchorage points are also provided. The seats are not suitable for child restraints that require a support leg as the seats are too high above the floor. Only use child restraints provided with top tethers.

Ascari and Voyager 400 Series

The Isofix anchorage points are located on the forward facing rear seats with 2x fixed positions provided. Ascari ISO point x1 located on the Aisle seat only.

The ISOFIX system comprises two rigid attachment arms on the child seat that attach to anchor points on the rear seat frame, located where the cushion and backrest meet. Positions are marked on the cushions.



Top tether anchor points are fitted on the upper seatbelt stanchion and are accessed by removing an insert on the backrest cushion.



General Seat Installation Method:

1. Place the child seat on the seat cushion.
2. Remove the top tether insert.
3. Route the tether strap to the anchor point and secure.
4. Push the child seat back firmly to engage the ISOFIX lower anchor points.
5. Tighten the tether strap in line with the child seat manufacturer's instructions.

⚠️WARNING: Please consult with the child seat manufacturer's instructions for full installation instructions. If in doubt please consult the child seat manufacturer's technical support team for further guidance on the installation.

⚠️WARNING: Do not attach the top tether strap to anything other than the correct top tether strap anchor point.

⚠️WARNING: Make sure that the top tether strap is not slack or twisted and is properly located on the anchor point.

⚠️WARNING: Make sure the child restraint rests tightly against the vehicle seat.

Voyager 500 series, Escape, Kon-Tiki 700 & 800 Series

ISOFIX anchorage points are provided on the Aguti rear fold up seats. Top tether anchorage points are located on the rear of the seat back.

To install a child restraint unfold the rear seat until the back of the seat is between 10° and 15°. Fit the base cushions ensuring that Velcro on the cushion engages on the Velcro on the seat base frame. Do not fit the seat back cushion.

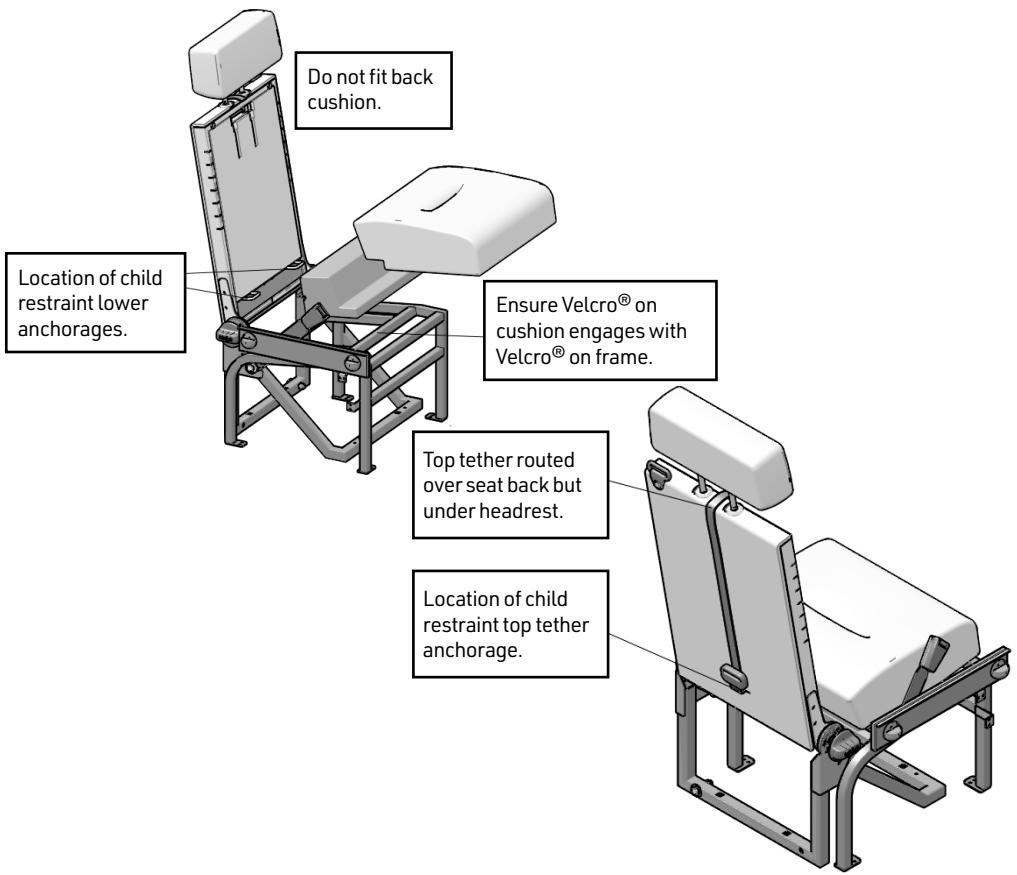

Follow the child restraint manufacturer's instructions for connecting the restraint to the lower anchorage points and attaching the top tethers. The top tethers must be routed over the top of the seat but under the head rest.

⚠ WARNING: Please consult with the child seat manufacturer's instructions for full installation instructions. If in doubt please consult the child seat manufacturers technical support team for further guidance on the installation.

⚠ WARNING: Do not attach the top tether strap to anything other than the correct top tether strap anchor point.

⚠ WARNING: Make sure that the top tether strap is not slack or twisted and is properly located on the anchor point.

⚠ WARNING: Make sure the child restraint rests tightly against the vehicle seat. You may need to adjust the seats to properly secure the child restraint.

ISOFIX CHILD RESTRAINT POSITION INFORMATION

Seating Position		Lateral Facing	Rearward Facing	Rearward Facing	Forward Facing	Rearward Facing
		0 - 10 kg	0 - 10 kg	0 - 13 kg	9 - 18 kg	9 - 18 kg
Front Passenger	Size class ¹	No ISOFIX				
	Fixture ¹					
2nd row RH rear Seat (Except Ascari)	Size class	X	E	C, D, E	A, B, B1	C, D
	Fixture	X	R1	R1, R2, R3	F2, F2X, F3	R2, R3
2nd row LH rear seat (Aisle seat Ascari)	Size class	X	E	C, D, E	A, B, B1	C, D
	Fixture	X	R1	R1, R2, R3	F2, F2X, F3	R2, R3
3rd row RH rear seat 674, 774 & 874 only	Size class	X	X	X	A, B, B1	X
	Fixture	X	X	X	F2, F2X, F3	X

¹The size class and fixture are defined for both universal and semi-universal child restraint systems. You can see the identification letters on ISOFIX child restraints.

X Seat is not suitable for use with this size class of child restraint system.

3.11 Three point seat belts

This section refers to the seat belts located in the habitation area of your motorhome.

Fastening the seat belt:

Insert tongue into buckle; a positive 'click' indicates correct assembly.

Releasing the seat belt:

Press the red release button, the tongue will be ejected from the buckle.

- The belt is designed for use by one person and must not be put around a child seated on a person's lap.
- The belt is suitable for restraining most child seats and boosters.
- The belt should at all times be adjusted and used in accordance with the instructions. No excessive slackness should be present.
- Once installed the diagonal should pass across the centre of the shoulder and the buckle should lie just on or below the hip.

Avoid twisting the webbing during use. Webbing must not be allowed to chafe against sharp edges.

- Do not make alterations or additions to the belt.
- Belts that have been cut, frayed, damaged or stressed through impact should be replaced. After impact the motorhome anchorage points should also be checked.
- To clean use warm soapy water only.
- Periodic inspection of the installation will ensure reliability of the seat belt.

3.12 Driving licence

Drivers who passed their car driving test (category B) before 1 January 1997 are usually allowed to drive a vehicle and trailer combination up to 8,250kg maximum authorised mass (MAM). You're also allowed to drive a minibus with a trailer over 750kg MAM.

The MAM is the weight of the vehicle or trailer which is listed in the owner's manual and is normally shown on a plate or sticker fitted to the vehicle or trailer.

Drivers who passed their test after 1997 can drive vehicles up to 3,500kg maximum authorised mass (MAM) with up to 8 passenger seats. Drivers can also tow a trailer that weighs up to 3,500kg MAM.

A number of Swift Group motorhomes have an MTPLM greater than 3500kg, therefore you must check you have the correct driving licence entitlement for the vehicle you drive.

3.13 Advice on towing

The towing capability of each motorhome differs depending on the specific chassis and engine types, (see 'Towing Capabilities' in your specification handbook).

This takes account of the maximum front and rear axle loadings as well as the minimum front axle loading in two conditions, MRO and MTPLM condition.

Towing in these, and any other condition requires sensible loading and distribution of payloads to ensure the requirements of the towing capability table are met.

When towing, the demands on both the vehicle and driver increase. A trailer reduces manoeuvrability, the ability to climb hills, acceleration and braking capacity and makes the vehicle handle and corner differently.

It will also increase the fuel consumption of the vehicle.

Always brake in good time. Special care must be taken when descending gradients. Change down before going down a steep hill so the engine can act as a brake. Ensure that the towing vehicle tyre pressures are correct and adjusted for full load conditions and that the trailer tyre pressures are as recommended by the trailer manufacturer. Regularly check the operation of trailer brakes and lights.

For maximum stability, when loading the trailer ensure that the loads are properly secured during transit. Position loads so that most of the weight is placed close to the floor and, where possible, immediately above or close to the axle(s). Where the load can be divided between trailer and tow vehicle, loading more weight into the vehicle will generally improve the stability of the combination. After loading the trailer, check that the nose weight and axle loads are in accordance with the manufacturer's recommendations, also check the rear and front axle loads on the motorhome. When calculating the laden weight of the trailer, remember to include the weight of the trailer PLUS THE LOAD.

Note: Towing regulations vary from country to country. It is very important to ensure that national regulations governing towing weights and speed limits are observed (refer to the relevant national motoring organisation for information). The stated maximum permissible towing weights refer to the

vehicle's design limitations and NOT to any specific territorial restrictions.

⚠ WARNING: The AL-KO extensions fitted to the Edge vehicles are not suitable for supporting a tow bar. Any tow bar and supporting structure fitted must be connected directly to the Fiat chassis. If a tow bar is required we recommend that the Al-Ko tow bar assembly, designed specifically for these vehicles, is purchased and fitted by your Swift motor home dealer.

⚠ WARNING: The chassis extensions fitted to the Voyager vehicles are not suitable for supporting a tow bar. Any tow bar and supporting structure fitted must be connected directly to the Ford chassis. Due to payload restrictions Swift do not recommend towing with the Voyager vehicles.

Notes:

1. Do not exceed the motorhome gross vehicle train weight.
2. Do not exceed the maximum front & rear axle loads on the motorhome.
3. Ensure the motorhome front axle load is never less than 40% or more than 70% of the total weight.
4. Motorhomes with an MTPLM up to 3500kg which have European Type approval can only be fitted with a type approved towbar complying to ECE R55.
5. The limit for towing an un-braked trailer is 750kg (based on VIN plate not actual weight), this applies to a towed car.
6. A car dolly with a car with a GVW over 750kg in place is considered as two trailers, these are legal for use for recovery but under the Road Traffic Regulations Act 1984 the combination is limited to 40 mph on motorways and dual carriageways and 20 mph elsewhere. A car dolly is not legal for transportation (there is a very specific difference between recovery and transportation. Recovery is defined as the removal of a broken down vehicle to a place of safety).
7. The maximum permitted vehicle combination length is 18.75m, however any combination must ensure compliance with the turning circle requirements of Construction and Use regulations 1986 & (EU) No. 1230/2012.

3.14 European Touring

Please note there are a number of requirements placed on a driver when driving on European roads. Carrying a warning triangle, high visibility jacket, first aid kit and spare bulb is now compulsory in many EU states but some EU countries are now introducing further regulations such as carrying a breathalyser kit and not being able to use satellite navigation systems with speed camera warnings.

We would advise customers to check on the many web-sites available to ensure you are carrying the correct equipment when touring in those EU countries.

4. En Route

4.1 Motorhome National Speed Limits	32
4.2 Cruise control	33
4.3 Parking sensors (where fitted)	33
4.4 Removal of spare wheel on ALKO conversion (where fitted)	33
4.5 Removal of Fiat spare wheel (where fitted)	34
4.6 Fiat Fix & Go Repair Kit (where fitted)	35
4.7 Inflation Procedure (FIAT) (Where fitted)	36
4.8 Bottle Replacement Procedure (FIAT) (where fitted)	37
4.9 Tyre Sealant and Inflator Kit (FORD) (where fitted)	37

4.1 Motorhome National Speed Limits

The national speed limit for your motorhome depends on the unladen weight of the vehicle and whether or not the vehicle is towing a trailer.

The unladen weight of the vehicle is the weight of the vehicle as delivered from the factory with the fuel tank empty. It does not include any LPG cylinders, water in the water tanks, personal possessions or driver and passengers.

The unladen weight for your vehicle can be found in the technical data handbook.

National Speed Limits

Vehicle	Built-up areas mph	Single carriageways mph	Dual carriageways mph	Motorways mph
Motorhomes with an unladen weight of 3050 kg or less	30	60	70	70
Motorhomes with an unladen weight greater than 3050 kg	30	50	60	70
All Motorhomes when towing a trailer	30	50	60	60

The speed limits given are national speed limits for motorhomes and motor caravans being used for their intended purpose. Be aware that if the motorhome is being used to carry goods for exhibition and sale, used as a workshop or used for storage then it is classed as goods vehicle and goods vehicle speed limits will apply irrespective of the unladen weight.

 **WARNING:** Local speed restrictions that differ from the above may apply and must be observed. These local restrictions will be clearly signed.

4.2 Cruise control

The driver of the vehicle should always remain seated and in control of the vehicle when cruise control has been engaged. Never leave the driving seat for any reason when the vehicle is underway.

4.3 Parking sensors (where fitted)

Parking sensors (and camera based systems) are fitted to some vehicles. Please use the information provided. Use the sensors as a guide only. It is the responsibility of the driver to ensure it is safe to reverse the vehicle.

4.4 Removal of spare wheel on ALKO conversion (where fitted)

⚠ WARNING: Exercise care when lowering the wheel and frame due to its weight.

Removal

- Spare wheel in the stowed position (Fig. 1).
- Remove the securing pins (a) from the supports (b) at each side of the spare wheel carrier frame (c) (Fig. 2).
- Lift the wheel carrier frame (c) slightly and move the frame supports (b) forward and clear of the carrier frame (Fig. 3).
- Lower the carrier frame and wheel to the ground (Fig. 4).
- Remove the spare wheel.

Replacement

Replacement is a reversal of the removal procedure. Ensure the securing pins (a) are correctly located in the frame supports (b).

Fig.1

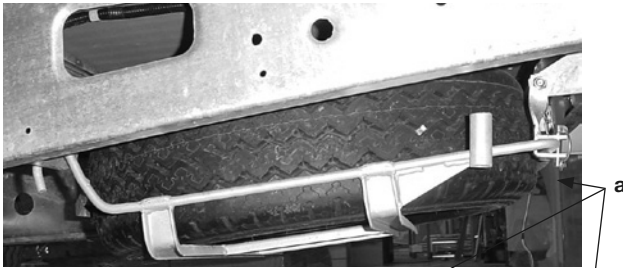

Fig.2



Fig.3



Fig. 4



4.5 Removal of Fiat spare wheel (where fitted)

- The ground should be flat and adequately firm.
- Turn the engine off and engage the handbrake.
- Engage first gear or reverse.

Removal

- Wheel restraining device screw (fig 1) – rear right side of vehicle
- Use the extension and wrench provided to operate the wheel restraining device screw (fig 2).
- When the wheel is fully lowered (fig 3) and the restraining device screw can turn no more, use the wrench to pull the wheel out (fig 4).
- (fig 4). Loosen the knob and remove the support to release the wheel (fig 5 & 6).



Fig. 1



Fig. 2

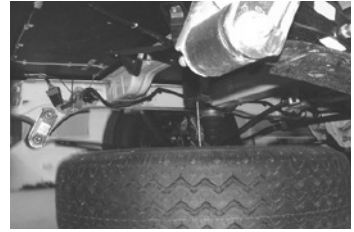

Fig. 3



Fig. 4



Fig. 5



Fig. 6

Note: It is possible that a transit zip tie may still be in place. If wheel does not drop freely check for zip tie.

Replacement

Replacement is a reversal of the removal procedure.

WARNING: Exercise care when handling the wheel due to its weight.

4.6 Fiat Fix & Go Repair Kit (where fitted)

CAUTION: Before use please read the user instructions supplied with your Fix & Go repair kit.

The Fix & Go automatic quick tyre repair kit is positioned at the front of the vehicle assenger compartment and includes Fig. A:



Fig.A

- Bottle A containing sealer and fitted with:
 - a transparent filler pipe B;
 - a black pressure restoring pipe E;
 - sticker C bearing the notice “max. 80 km/h”, to be placed in a position visible to the driver (on the instrument panel) after fixing the tyre;
- Instruction brochure (see fig. b), to be used for prompt and correct use of the quick tyre repair kit and then to be handed to the personnel charged with handling the tyre treated with the tyre repair kit;
- A compressor D complete with pressure gauge and connectors; a pair of protective gloves located in the side compartment of the compressor;
- Adaptors for inflating different elements

CAUTION: Give the instruction booklet to the tyre repair workshop personnel.

CAUTION: Punctures on the sides of the tyre cannot be repaired. Do not use the quick tyre repair kit if the damage is due to running with flat tyre.

CAUTION: If the wheel rim has been damaged (bent so as to cause air to leak), the wheel cannot be repaired. Do not remove the foreign body (screws or nails) from the tyre.

① **Note:** Punctures caused by foreign bodies can be repaired if the damage does not exceed 4 mm on the tread and on the shoulder of the tyre.

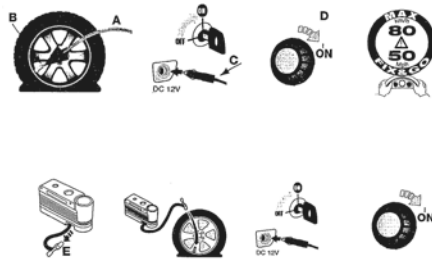

Fig.B

Important Information:

The sealing fluid of the quick tyre repair kit is effective at external temperatures of between -20 °C and +50 °C. The sealant has an expiry date.

CAUTION: The bottle contains ethylene glycol. It contains latex that might cause allergic reactions. It is harmful if swallowed. It is irritant for the eyes. It may cause sensitisation if inhaled or on contact. Avoid contact with eyes, skin and clothes. In the event of contact, wash immediately with plenty of water. Do not induce vomiting if swallowed. Rinse your mouth and drink plenty of water. Call a doctor immediately. Keep out of the reach of children. The product must not be used by asthmatics. Do not breathe in the vapours during insertion and suction. Call a doctor immediately if allergic reactions are noted. Store the bottle in its proper compartment, away from sources of heat. The sealant has an expiry date on the base of the bottle. Replace the bottle.

4.7 Inflation Procedure (FIAT) (Where fitted)

CAUTION: Wear the protective gloves provided together with the quick tyre repair kit.

CAUTION: Affix the adhesive label in an easy-to-see position for the driver as a reminder that the tyre has been treated with the quick tyre repair kit. Drive carefully, particularly on bends. Do not exceed 80 km/h. Do not accelerate or brake suddenly.

CAUTION: If the pressure falls below 3 bars, do not drive any further: the Fix & Go automatic quick tyre repair kit cannot guarantee proper hold because the tyre is too much damaged. Contact a Fiat Dealership.

CAUTION: You must inform the dealership that the tyre has been repaired using the quick tyre repair kit. Give the booklet to the personnel who will be handling the tyre treated with the repair kit.

CAUTION: If different tyres from the ones supplied with the vehicle are used, it may not be possible to carry out the repair. If the tyres are replaced, it is advisable to use those approved by the manufacturer. Consult a Fiat Dealership.

- Pull the handbrake. Unscrew the tyre valve cap, take out the filler hose A (Fig. C) and tighten the ring nut B on the tyre valve;
- Insert the plug E (Fig. E) in the nearest 12V power socket and start the engine. Turn the selector D (Fig. D) anti-clockwise to the repair position. Activate the kit by pressing the on/off switch. Inflate the tyre to the pressure specified in the "Inflation pressure" paragraph, in the "Technical Data" chapter;

For a more accurate reading, it is advisable to check the pressure reading on the pressure gauge F (Fig. D) with the compressor off and without moving the centre selector from the repair position

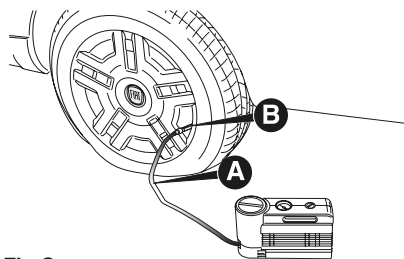

Fig C

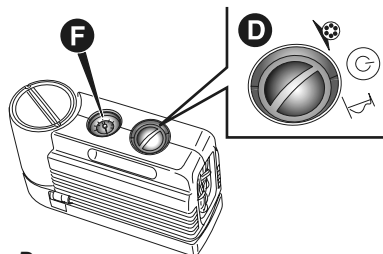

Fig D

- If after 10 minutes it is still impossible to reach at least 3 bar, release the transparent filler pipe from the valve and take out the 12 V plug, then move the vehicle forwards by about 10 metres in order to distribute the sealing fluid inside the tyre evenly, then repeat the inflation operation;
- If after this operation you still cannot reach at least 3 bar after 10 minutes, do not resume driving because the tyre is too damaged and the quick tyre repair kit cannot guarantee suitable sealing. Contact a Fiat Dealership;
- If the tyre reaches the pressure specified in "Inflation pressure" paragraph in the "Technical Data" section of the Fiat user manual start driving immediately;

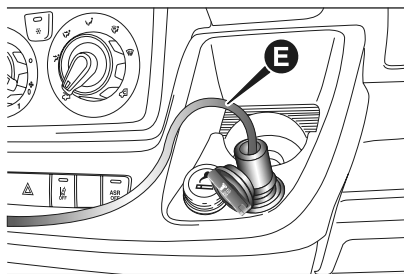

Fig E

After having driven for about 10 minutes, stop and recheck the tyre pressure; remember to apply the handbrake;

If a pressure value of at least 3 bar is detected, inflate to the correct pressure, resume driving and drive with care to nearest Fiat Dealership.

4.8 Bottle Replacement Procedure (FIAT) (where fitted)

To replace the bottle, proceeds follows:

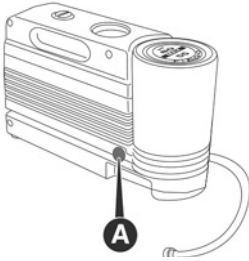

Fig. F

Press button A (Fig. F) to release the part;

Fit the new bottle and press until it is automatically engaged.

CAUTION: Replace the bottle containing the sealant after the expiry date. Expiry date is shown on the base of the bottle. Dispose of the bottle and the sealant properly. Have the sealing fluid and the bottle disposed of in compliance with national and local regulations.

4.9 Tyre Sealant and Inflator Kit (FORD) (where fitted)

What is the tyre sealant and inflator kit

The kit consists of an air compressor to re-inflate the tyre and a canister of sealing compound that effectively seals most punctures. This kit provides a temporary tyre repair allowing you to drive your vehicle up to 200km (120 mi) at a maximum speed of 80 km/h (50 mph) to reach a tyre service location.

Tyre sealant and inflator kit precautions

⚠ WARNING: Depending on the type and extent of tyre damage, some tyres can only be partially sealed or not sealed at all. Loss of tyre pressure can affect vehicle handling, leading to loss of vehicle control.

⚠ WARNING: Do not use the kit on a previously damaged tyre. For example, when it has been driven under-inflated. This when it could has cause been loss of vehicle control, personal injury or even death.

Do not attempt to repair punctures larger than 6mm (0.24 in) or damage to the tyre's sidewall.

Only punctures located within the tyre tread can be sealed with the kit.

Only use the kit supplied with your vehicle.

The temporary mobility kit contains enough sealant compound in the canister for one tyre repair only.

After using the sealant, an authorised dealer needs to replace the tyre pressure monitoring system sensor and valve stem on the wheel.

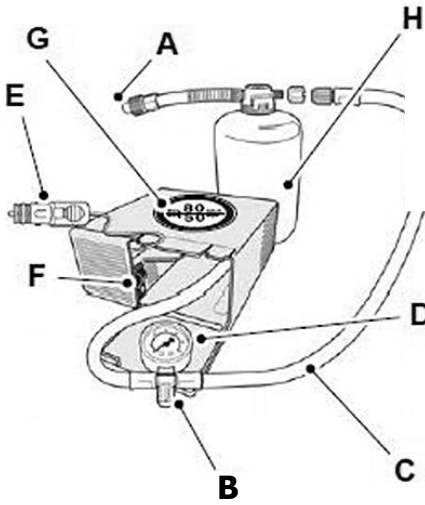

E146784

- A) Protective cap
- B) Pressure relief valve
- C) Hose
- D) Pressure gauge
- E) Power plug with cable
- F) Compressor switch
- G) Label
- H) Sealant bottle

Note: Make sure you regularly check the expiry date on the sealant bottle.

Using the tyre sealant and inflator kit

WARNING: The sealant contains natural rubber latex. Avoid contact with skin and clothing. If this happens, rinse the affected areas immediately with plenty of water and consult a physician.

WARNING: Do not leave the kit unattended when it is in use. Failure to follow this instruction could result in personal injury or death.

WARNING: Check the sidewall of the tyre prior to inflation. If there are any cracks, bumps or similar damage, do not attempt to inflate the tyre. This could cause personal injury.

1. Check for a punctured tyre.

Note: Do not remove objects. For example, nails or screws from a punctured tyre.

2. Open the lid of the tyre sealant and inflator kit.
3. Peel off the label G showing the maximum permissible speed of 50 mph (80 km/h) from the casing and attach it to the instrument panel in the driver's field of view. Make sure the label does not obscure anything important.
4. Take the hose C and the power plug with cable E out of the temporary mobility kit.
5. Screw the hose C onto the sealant bottle.
6. Remove the valve cap from the damaged tyre.
7. Remove the protective cap A from the sealant bottle hose and screw the hose firmly onto the valve of the damaged tyre.
8. Make sure that the compressor switch F is in position 0.
9. Insert the power plug E into the auxiliary power point.
10. Start the engine.

WARNING: Do not stand directly beside the tyre while the compressor is operating. This could cause personal injury if the tyre bursts.

11. Move the compressor switch F to position 1.
12. After a minimum of two minutes, move the compressor switch F to position 0 and unscrew the hose C from the sealant bottle. Unscrew the sealant bottle hose from the tyre valve.
13. Screw the hose C onto the tyre valve and move the compressor switch F to position 1.

WARNING: Watch the sidewall of the tyre when inflating. If any cracks, bumps or similar damage appears, switch the compressor off and let the air out by means of the pressure relief valve. Do not continue driving with this tyre. This could cause loss of vehicle control.

WARNING: Do not keep the compressor operating for more than 10 minutes. This could cause the compressor to malfunction causing serious personal injury.

5. Safety and Security

5.1 Fire	40
5.2 Fire Extinguisher	40
5.3 Escape paths	40
5.4 Children	40
5.5 Ventilation	41
5.6 CO alarm	41
5.7 Security	41
5.8 Swift Command Tracker by Sargent (where fitted)	42
5.9 VIN CHIP™	43

5.1 Fire

📄 **Note:** Your attention is drawn to the notice affixed inside the wardrobe advising on fire precaution, ventilation and what to do in case of fire.

In case of fire

Get everyone out of the motorhome as quickly as possible using whichever exit is the quickest, including windows. Do not stop to collect any personal items.

Raise the Alarm. Call the Fire Brigade.

Turn off the gas supply valve if it is safe to do so.

Turn off the electricity supply at supply point.

Smoke Alarm Operation



Your motorhome is fitted with a Fire Angel SB1 smoke alarm. Please read the user instructions for the smoke alarm, which are available at the following location:

<https://www.fireangel.co.uk/products/sb1-t>



If you are unable to view the documents on line, please contact the supplier, your dealer or Swift for an electronic or paper copy.

⚠️ **WARNING:** Never use portable cooking or heating equipment other than electric heaters that are not of the direct radiant type, as it is a fire and asphyxiation hazard.

⚠️ **WARNING:** Appliances such as cookers must not be used for heating.

5.2 Fire Extinguisher

It is recommended that a dry powder fire extinguisher be carried inside your motorhome at all times.

When using a dry powder extinguisher it is suggested that the motorhome be evacuated until the powder has settled, to avoid inhalation.

A fat pan fire should not have a fire extinguisher aimed at it. It should be smothered with a fire blanket.

⚠️ **WARNING:** Provide one dry powder fire extinguisher of an approved type or complying with EN3-7 or ISO 7165, of at least 1kg capacity, by the main exterior door and a fire blanket next to the cooker. Familiarise yourself with the instructions on your fire extinguisher and the local fire precaution arrangements.

5.3 Escape paths

In the event of an emergency, the main entrance door is the primary emergency exit on all layouts. Additional emergency exits are provided on most layouts via large windows. This also includes layouts that contain a separate bedroom that is separated by a solid door.

It is important that you do not block escape paths to emergency exits with obstructions or hazards.

5.4 Children

Do not leave children alone in the motorhome in any event. Keep potentially dangerous items out of reach, as at home e.g. matches, medicine etc.

5.5 Ventilation

All motorhomes comply with BS EN 721. The ventilation points on your motorhome are fixed points of ventilation which are required by the European Standards.

All motorhomes have ventilation at high level and low level which have been calculated to suit the individual needs of your motorhome.

High level ventilation is achieved by means of the roof lights and washroom roof ventilators (where applicable). The low level ventilators are positioned under sink units/fridge cupboards.

Under no circumstances must these vents be blocked or obstructed in any manner as this could lead to insufficient fresh air. In this case the confined atmosphere becomes depleted of oxygen which could lead to dangerous levels of carbon dioxide (CO₂) build up leading to the risk of asphyxiation.

The risks of carbon monoxide (CO) build up, which is a colourless, odourless and tasteless gas, will also be reduced with ventilation.

Carbon monoxide is produced from incomplete combustion and should the CO detector be activated the cause of the incomplete combustion must be investigated prior to reusing the appliance in question.

It is advised that fixed ventilation points are checked and cleaned (if necessary) on a regular basis using a small brush and a domestic vacuum cleaner.

Additional night time ventilation is obtained by releasing the window catches and placing them in the second groove. Note the windows are not sealed from rain in this position.

As the ventilation levels are calculated to suit each model requirements no modifications should be made which may result in reduced ventilation levels.

⚠ WARNING: Do not obstruct ventilation.

5.6 CO alarm



Your motorhome is fitted with a FireAngel FA3820 Carbon Monoxide Alarm. Please read the instructions for the alarm, which are available at the following location:

<https://bit.ly/3qmC1l2>



If you are unable to view the documents on line, please contact the supplier, your dealer or Swift for an electronic or paper copy.

5.7 Security

Motorhome theft:

The theft of a motorhome can occur in the most unlikely circumstances; from a motorway service area or even an owner's driveway. Secure all windows and doors when your motorhome is unoccupied even if only for a short length of time.

VIN (Vehicle Identification Number)

Record your motorhome VIN. This can be found at the bottom of the windscreen, on the Swift and Ford plates on the passenger cab door B pillar or on the Fiat plate on front cross member within the engine compartment.

Make a note of these numbers in the space provided at the front of this handbook and make a separate note of the numbers to keep safe at home.

Additional security

Consider fitting any device which might deter intrusion by thieves. Customers are advised to identify their motorhome with a method for subsequent identification if other forms of identification have been altered or removed.

Free crime prevention advice about securing your motorhome, protecting your valuables, property marking either at home or whilst on site, can be obtained from the Crime Prevention Officer through your local Police station.

5.8 Swift Command Tracker by Sargent (where fitted)

A Swift Command Tracker when built into your vehicle forms part of the Swift Command system.

The unit is Thatcham Category S7 certified and is monitored by an approved monitoring centre which operates 24 hours a day 7 days a week and provides European coverage and direct police liaison.

This system is ready for use, all you need to do is purchase a tracking subscription by visiting www.swiftcommand.co.uk or calling Sargent on 01482 881655.

For more information including subscription costs please visit:
www.swiftcommand.co.uk

Operation

The Swift Command Tracker is easy to operate as it is controlled by the vehicle systems.

In a motorhome the tracker is armed / disarmed by the ignition key.

When the ignition is turned off the tracker is armed. When the ignition is turned on the tracker is disarmed.

Event of a Theft

If the vehicle is moved whilst the tracker is armed the geo-fence monitoring will trigger a theft event.

The monitoring station will now contact you to confirm the theft or false alarm. You will be required to confirm your identity against the information you provided when you subscribed.

If a genuine theft is confirmed the monitoring station will liaise with the police and keep you informed of progress.

Note: during a theft event to comply with legislation you will not be able to manually locate your vehicle using the Swift Command locate feature.

Contact

Before contacting any of the following please ensure you know your caravan or motorhome serial number. For motorhomes this is the unique MH number (like MH01234).

The Swift Command Tracker monitoring station can be contacted on 0345 6027302. The stations operates 24 hours a day 7 days a week.

Sargent customer support can be contacted on 01482 678981 or via support@swiftcommand.co.uk

Telephone lines are manned during normal office hours.

Swift customer support can be contacted on 01482 875740 during normal office hours.

Precautions

The Swift Command Tracker monitors the leisure battery supply and if the voltage falls below a set level or the battery is removed this will trigger a fault event.

If you plan to remove your battery for maintenance or external charging please contact the monitoring station BEFORE removing the battery.

If you lose an ignition key you will need to visit a Fiat dealer for key replacement and removal of the 'lost' key.

5.9 VIN CHIP™

Your motorhome has been securely marked and the VIN recorded with VIN CHIP™.

VIN CHIP™ is the industry standard security marking system for touring caravans and motorhomes.

Shortly after purchasing this motorhome, you will receive via email your VIN CHIP™ registration document. This document will include the 17 digit VIN (vehicle identification number) and other relevant details about your motorhome. If you sell your motorhome, please follow the instructions on the VIN CHIP motorhome document.

VIN CHIP identification

The motorhome's unique 17 character VIN will be incorporated into VIN CHIP tamper evident labels;

The master VIN CHIP label is situated on the front near side window to aid police checking, another in the gas locker and a maximum of 10 placed on the inside of the windows (with the exception of opaque windows).

Three electronic RFID chips containing the individual identity of your motorhome are concealed within the vehicle and can only be read by using a specially programmed RFID scanner.

Your local police can obtain the use of a VIN CHIP™ scanner by contacting VIN CHIP on tel: 0333 2124746.

For help, support and advice, contact:

VIN CHIP
PO Box 445
Aldershot
GU11 9SF

Tel 0333 2124746

www.vinchip.co.uk

6. Arrival at the site

6.1 Positioning the motorhome	46
6.2 Awnings and Tents	46

6.1 Positioning the motorhome

Note: Check and observe site regulations.

Keep to roadways unless otherwise directed. Adhere to speed limits. Note that these are generally 10mph.

(Remember that the stopping distance on grass is considerably greater than on tarmac.)

Only a person in possession of a current driving licence may drive on the site.

Selecting a pitch

Do not pitch in such a position that your motorhome will obstruct others coming in.

Try to choose an area which is dry, reasonably level and preferably with a hard base.

If you have no alternative but to pitch on a slope try to ensure that you are facing down the slope, for when you leave.

Levelling the motorhome

Levelling must be carried out in both directions for the refrigerator and other equipment to function correctly. Stepped levelling boards (Fig. A) or proprietary ramps are ideal for this purpose. Levelling pads or boards should be used under the wheels where the ground is soft or uneven.



Fig. A Stepped levelling board

6.2 Awnings and Tents

Awnings and tents should only be used when permission has been obtained. When on grass and staying for more than a few days the ground sheet and/or side flaps of awnings should be periodically raised in order to avoid damage to the ground.

7. Services

7.1 Water system - Introduction	48
7.2 Fresh water system	49
7.3 Priming the Water System	50
7.4 Cleaning water system	51
7.5 Pressure switch	52
7.6 Waste water system	53
7.7 Tank heaters	53
7.8 Water level sensor & cleaning	54
7.9 Water fault finding	55
7.10 Gas	59
7.11 Types of gas	60
7.12 En-route heating (where fitted)	61
7.13 Gas safety advice	62
7.14 Gas fault finding	64
7.15 The electrical system	65
7.16 230V mains electrical equipment power consumption	66
7.17 Wiring of connecting cable and motorhome mains inlet	67
7.18 Typical appliance consumption figures	68

7.1 Water system - Introduction

General advice

All Swift Group motorhome water systems have been designed around a pump fitted within the motorhome. This pump draws water from an under floor or internal water tank, to provide water pressure within the water system, whenever it is switched on and water is available.

The schematic below shows the basic configuration of the water system:

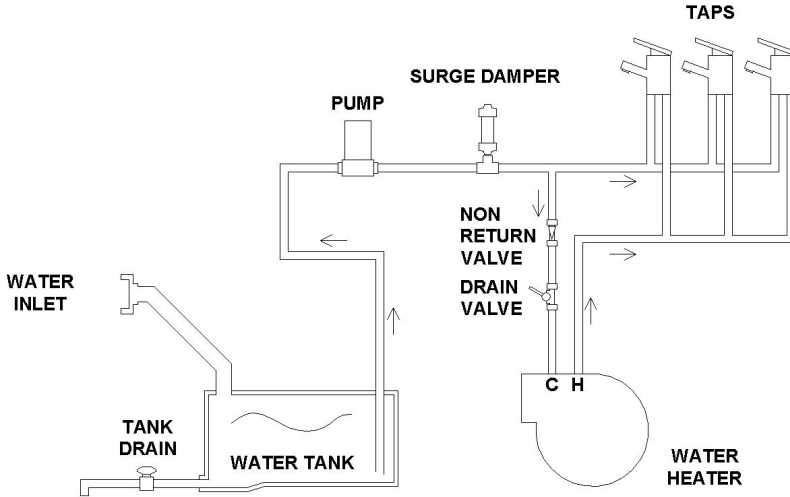

When power is supplied to the pump, it will draw water from the water tank, and pump it to the motorhome taps, shower and water heater.

The pump is fitted with its own pressure switch, and will continue to pump water, until the pressure of water on the output of the pump reaches a pre-set level. For this pressure to be achieved, the taps must be closed.

When the taps are opened, water will leave the tap via the spout, and the pressure in the pipes between the pump and the taps will reduce. Because of this reduction in pressure, the pressure switch on the pump will switch back on and the pump will again run to pump more water.

Close to the pump, the water under pressure is split into two paths:

Through blue water pipes routed directly to the cold connection of each tap.

To the water heater.

Water from the pump enters the bottom of the water heater. Once the water fills the water heater (typically 10 litres), water then leaves the water heater via a connection at the top of that water heater. This water, which is still under pressure, then routes to the hot connection of each tap via the red pipes.

To winterise the system please see separate details later in this handbook.

7.2 Fresh water system

All fittings, including the holding tank, water pipes, taps and connections are of food quality material (to BS6920) and therefore, should not affect the quality of the water used. It is recommended however, that the system is flushed through twice before it is used for the first time, and always cleaned/flushed after it has stood unused for a period of time (eg over the winter period). Care has been taken (using smooth bore pipes etc) to eliminate as many water traps as possible.

When filling the fresh water system remember to check that the water source is suitable for use as drinking water. If possible avoid using water sources which use desalination or other similar processing, as they may contain chemicals that could damage the stainless steel components within your motorhome water system. If in doubt, check locally before using a water supply.

If you are using a hose pipe or water carrier, ensure this is made from nontoxic materials (preferably food grade material)

Motorhome Water Tank Drains

Depending on the specification, the fresh water tank will be fitted with either a bung in the bottom of the tank, or a manually or electrically operated drain valve. Check the bung is in place, or the valve is closed, before filling the fresh tank:

Voyager models

Locate the blue plastic drain valve on the rear offside of the vehicle under the side skirt and turn the tap to open or close the valve.

Escape and Ascari models

Controls for the electrically operated drain valves are present in the upper kitchen cupboard, valves on the fresh and waste tanks can be controlled separately.

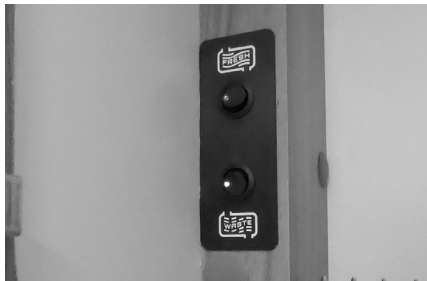

An LED indication on each switch will show whether the drain valve is open (Amber LED) or closed (Green LED).

Kon-Tiki models

The electrically operated drain valves are normally closed. On the control panel above the door, on the fresh water / waste water tank screen 'drain' buttons can be pressed to open the valve(s).

The valves will close automatically after 10 minutes, or if the power is switched off. See the EC970 instructions later in this handbook for further detail.

Boiler / Water System Drain

The boiler / water system drain valve is located close to Alde or Truma heating appliance. To drain the system lift the yellow handle to the vertical position (f) The drain is closed when the handle is in the horizontal position (e).

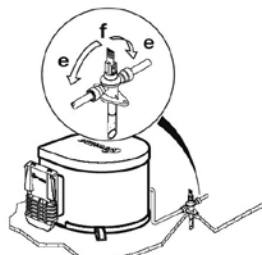

⚠ WARNING: The fresh water system is pressurised by a pump which will continue to operate until it senses a pre-set pressure in the system.

If the fresh water tank is completely empty the pump will be unable to pressurise the system and will operate continuously. In this situation it is essential that, in order to avoid damage to the pump, it is switched off using the pump isolator switch on the distribution panel until such time as the water tank has been filled.

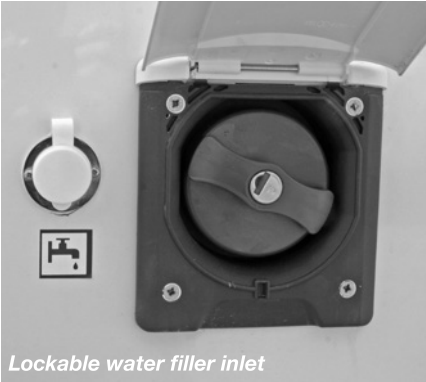

Lockable water filler inlet

Fresh Water Tank

Your motorhome is fitted with a water tank filled from the outside via a lockable water filler cap. When filling, use a hose manufactured from non toxic material, to prevent tainting of the water. Remember, if the water heater has been drained it will require 10 litre (0.2 gal) of water to fill it.

External 12v Fill Socket

Depending on specification your motorhome may be fitted with an external 12v socket which can be used to attach an external 12v tank filling pump.



7.3 Priming the Water System

When water is first introduced, or the water supply in the internal tank, runs out, air will be present in the pipework. It is important that every tap is run to remove any air in the system before, for instance, the shower is used. Air left in pipework local to a tap can act as an accumulator and affect the ratio of hot and cold water flowing from other taps or shower mixers in the system.

1. Close the fresh water tank drain valve.
2. Fill the water tank with water.
3. Close the water heater drain valve (see boiler instructions in the fitted equipment section)
4. Open all the taps except the shower tap. Mixer taps should be opened in the central position so that both the hot and cold pipes are purged of air. Ensure the tap spouts are over the sinks.
5. Turn on the pump using the button on the control panel above the entrance door.
6. Turn each tap off in turn as and when the air is expelled and the water runs smoothly from each tap. Move the mixer taps to hot and then cold to check that the air is out of both the hot and cold pipes before turning them off.
7. Whilst holding the shower head down towards the shower drain, open the shower tap and shower head tap until all the air is expelled and the water runs smoothly. Turn the shower taps off.
8. Top up the fresh tank with water.

Please note that priming the system will automatically fill the water heater with water.

Please ensure all taps are fully turned off when not in use (except when winterising).

ⓘ Note: All tanks are fitted with a breather which acts as an overflow. Overfilling a tank will result in water being expelled from the overflow outside the vehicle.

7.4 Cleaning water system

Clean the water system at the start and end of the season with sterilising fluid.

Sterilising

When cleaning the water system at the start or the end of the season it is advisable to use a suitable sterilising fluid available from your motorhome dealer. The fluid must be suitable for use with stainless steel components

Flush the system thoroughly to remove the effective fluid traces.

When water is first introduced, or the water supply in the internal tank, runs out, air will be present in the pipework. It is important that every tap is run to remove any air in the system before, for instance, the shower is used. Air left in pipework local to a tap can act as an accumulator and affect the ratio of hot and cold water flowing from other taps or shower mixers in the system.

System care

Allowing water to freeze in the system may result in damage to the pump and plumbing system.

Non-Toxic antifreeze for potable water may be used with Truma pumps. Follow manufacturers recommendations.

Do not use automotive antifreeze to winterize potable water systems.

These solutions are highly toxic and may cause serious injury or death if ingested.

Sanitising

The water systems, and in particular storage tanks, in motorhomes are susceptible to contamination by bacteria if care is not taken with their use and cleaning. The symptoms caused by bacterial contamination are not purely limited to gastro-intestinal diseases, but may also manifest themselves as ear, nose, throat, eye or skin infections. It is therefore important that you carry out the following procedure prior to using the motorhome each time, even if you boil or filter all water you use for drinking.

Separate Water Containers

1. All water remaining in the container should be disposed of so that the container is empty.
2. The outside of the container should be thoroughly cleansed and washed down to remove any dirt, dust or other contaminant. Water at a suitably hot temperature containing an appropriate detergent is recommended for this purpose.
3. Water should be put in the container, swirled around, then emptied out.
4. The container should then be totally filled with water containing an appropriate sterilant solution and allowed to stand for the recommended contact time.
5. The solution should be emptied from the container.
6. The opening of the container should be cleaned thoroughly with an appropriate prepared wipe impregnated with a sterilant.

- The container should be inverted whilst stored overnight (if possible).
- The container must be filled with mains water only and mains water only should be used for the above cleaning procedure.
- On no account should garden hoses be used to fill water tanks.

For Systems:

- Drain down the system (open all taps to allow air in, enabling the system to drain quickly).
- Remove any water filters fitted, and replace with a short length of hose or empty filter cartridge (this will ensure the filter is not affected by the disinfectant/sterilant solution).
- Fill the water system with a disinfectant/sterilant solution (check that the solution at full strength appears at all taps/showers). Allow to stand for the recommended period of time.
- Drain the system completely.
- Thoroughly clean the outside of all taps/connectors with a cloth soaked in the disinfectant/sterilant.
- Flush the system through with clean drinking water until no traces of disinfectant/sterilant can be detected at any tap.

Suitable sterilising chemicals are available from your motorhome dealer, accessory shop, chemist or home-brew shops. It is not, however, recommended to use bleach or sodium metabisulphite.

Sterilising

Do not use products that contain aggressive agents for sterilising the water system. Always use products designed for stainless steel tanks available from your motorhome dealer.

ⓘ Note: Never use the water heating system when disinfectant/sterilising fluid is present. Doing so may damage the system.

7.5 Pressure switch

The purpose of a pressure switch is to monitor the pressure on the outlet side of the pump. When a tap is closed, and the pump continues to run, there is an increase of pressure in the system, and when that pressure reaches a pre-set limit, the pressure switch will turn the pump off.

Pressure switch adjustment

Pressure Switch Adjustment, Truma/Flo-Jet pump. (Normally Grey upper section with White lower section/valve housing)

- All of the Truma/Flo-Jet pumps used by Swift are pre-set at 25psi - 31psi.
- To further adjust the pressure switch setting, a cover cap must be first be removed from the end of the pump to reveal a pressure adjusting screw, as shown in the photos. A maximum of 1/4 turn clockwise or anti-clockwise, from the factory setting, is advised. Turning the screw clockwise 1/4 turn will increase the pressure switch cut-out pressure, turning the screw anti-clockwise will reduce the pressure setting.
- Please note a second screw mounted below the cover cap is set in position with threadlock, this should not be disturbed.

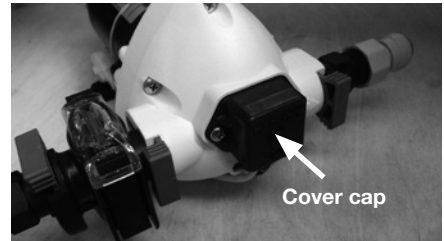

The pump may have to be removed to gain access to the adjusting screw. Drain the water system before removing the pump.

To remove the pump pull the blue taps at right angles to the pipe work and lift the pump out.

7.6 Waste water system

1. The waste water holding tank is secured below the floor of the motorhome, and is gravity fed.

Note: Should the waste water tank be overfilled, it is possible that waste water will backfill the pipes until it eventually appears in the shower tray. In order to prevent this, please monitor the water level gauges on the motorhome control panel. It is also possible to enable a 'waste tank full' alarm, on the control panel.

2. Depending on the specification, the waste water tank will be fitted with either a manually or electrically operated drain valve.

Voyager models

A grey manually operated drain valve will be located externally, close to the motorhome skirt.

Escape and Ascari models

Controls for the electrically operated drain valves are present in the upper kitchen cupboard.



An LED indication on each switch will show whether the drain valve is open (Amber LED) or closed (Green LED).

Kon-Tiki models

The electrically operated drain valves are normally closed. On the control panel above the door, on the fresh water / waste water tank screen 'drain' buttons can be pressed to open the valve(s).

The valves will close automatically after 10 minutes, or if the power is switched off. See the EC970 instructions later in this handbook for further detail.

7.7 Tank heaters

Depending on specification, your motorhome may be fitted with 12v tank heaters, designed to prevent or reduce instances of freezing water in fitted water tanks.

If tank heaters are fitted, they can be turned on via the control panel above the entrance door. For Ascari and Escape the control is a button on the fascia of the EC400+ control panel. For Kon Tiki the control is in the water system page of the EC800 touch screen control panel. Turn the feature on when external temperatures are low, and the tank heaters will then provide heat automatically, and only when required.

Before heating each tank the system will check that the water level in each tank is at the 1/4 level or higher (the heaters will not operate if the tank is 'empty'). If the water level is appropriate, the heaters will then switch on and off depending on temperature.

As the tank heaters check the water level in each tank, the fresh and waste water tank heaters can operate independently, for instance use of frost protect feature while the fresh tank is full, but waste tank is empty, would only result in the operation of the fresh tank heater.

It is also possible to use the tank heaters en-route, i.e. while driving. With the control panel ON, turn on the tank heaters as described above. While the engine is running the control panel cannot be operated, however, the tank heater circuits will remain ON.

Please note that the heating elements use a 12V supply. With the engine off, and if used without a mains hook up and charger operating, then leisure battery power consumption will be increased (see consumption table on page 64 for more information).

7.8 Water level sensor & cleaning

Principle

The sensor, fitted to Swift Group motorhomes are pre-fitted to water tanks, and link to the control unit, via a pre-fitted wiring harness. The sensors, which consist of a number of stainless steel rods or probes, at different lengths, are immersed in the fresh or waste water, and use the conductivity of water, between the probes, to provide a reading to the control unit.

The sensors are 'digital', in that while the conductivity (resistance) value can vary, the fusebox will register any conductivity between the reference probe and the various different length probes, indicating water present.

Normally, even if the rods are dirty, and providing the rods have not bridged by a foreign object, a circuit will still be delivered back to the control unit and a water level displayed.

Sensor cleaning

The first step, in case of fault diagnosis, is to clean the sensor rods. False water level readings at the control unit can be caused by calcium build-up or foreign objects within the tank bridging the probes. (Especially with waste tanks).

To clean sensor:

⚠ WARNING: Only use food safe plastic mesh scourers, which are suitable for domestic use, for cleaning the sensor studs.

1. Remove the sensor from the tank
2. Check the probes for build up of contamination
3. Use clean, soapy water
4. Place scourer in water to dampen
5. Apply scourer to the sensor probes with limited pressure
6. Rub sensor probes, removing contamination
7. Swill sensor probes with fresh, clean water
8. Replace sensor into tank.

📌 Note: Tank levels are measured in increments of 25%

7.9 Water fault finding

Fault	Cause	Remedy
Water not flowing from any tap when operated but pump runs	Freshwater tank empty	Check
	Water system not primed	Ensure water system has been primed correctly, (see priming the water system section 7.3), and there are no air-locks present
	Pump wired in reverse	Check wiring, refer to pump manufacturer's instructions
	Pipe inlet or outlet pipe disconnected	Check connections
	Pump pipes restricted by kinking	Check pipe runs Check, starting at the freshwater tank
	Blocked pump filter	Dismantle and clean filter. See pump manufacturer's instructions.
	Air leak in suction line to pump	Check condition of pipe and pipe joints between the water tank and the pump.
	Frozen pipes	Defrost pipes
Pump does not run	No electrical power	Check battery is connected and charged or electrical hook up connected
	Pump fuse blown	Check wiring connection and then replace with fuse of correct rating
	Pump incorrectly wired	Refer to pump manufacturers instructions
	Low voltage	Using a multimeter check that the voltage is between 10 and 14.5 volts. If it is, refer to your dealer.
	Pump seized or overheated	Allow to cool before retrying and if still not working refer to pump manufacturers servicing instructions
	Pressure pump sensing switch may have failed or requires adjusting	Refer to pump manufacturers servicing instructions and section 7.5 for adjusting the pressure switch

Water Fault Finding

Fault	Cause	Remedy
Pump does not run	Contacts may be faulty	Check contacts in plug and socket are clean and making contact
	Wiring connections may be faulty	Check wiring connections
	Frost damage to pump due not draining overwinter	Replace pump
Water flows from cold tap but not from hot	Blockage in hot pipeline	Disconnect pipes and inspect
	Heater inlet or outlet pipes kinked preventing flow	Check and re-route if necessary.
	Hot tap failed or blocked Heater	Disconnect and inspect
	non-return valve jammed	Seek service attention
Water flows from hot tap but has reduced flow from cold	Cold water pipe kinked preventing flow	Check and re-route if necessary
	Blockage in cold pipe line	Disconnect pipes after 1st connector and check up to tap
	Cold tap not connected	Refer to installation instructions
	Cold tap failed or blocked	Disconnect and inspect

Fault	Cause	Remedy
Reduced flow from both hot and cold taps	Battery condition low causing pump to run slowly	Check battery state of charge, refer to electrical supply note
	If new taps have been fitted they may be restricting flow	Disconnect and check that they have at least 1/4" (6.3mm) bore
	Pump needs servicing	Refer to pump servicing instructions
	Partially blocked pump filter or in-line filter, if fitted	Dismantle and clean if necessary
	Pump outlet pipe kinked restricting flow	Check and re-route if necessary
	Water leak	Check all water connections
Reduced flow from either tap	Pipe kinking restricting flow	Check and re-route if necessary
	Bore size difference in taps	Use taps of equal bore size
If pump motor runs steadily and will not stop	Battery voltage may be too low (below 10.5 volts)	Check that there is water in the container Adjust switch and/or re-charge battery. Check all connections in pipework

**Typical gas schematic drawing with
Combi or Alde Boiler**

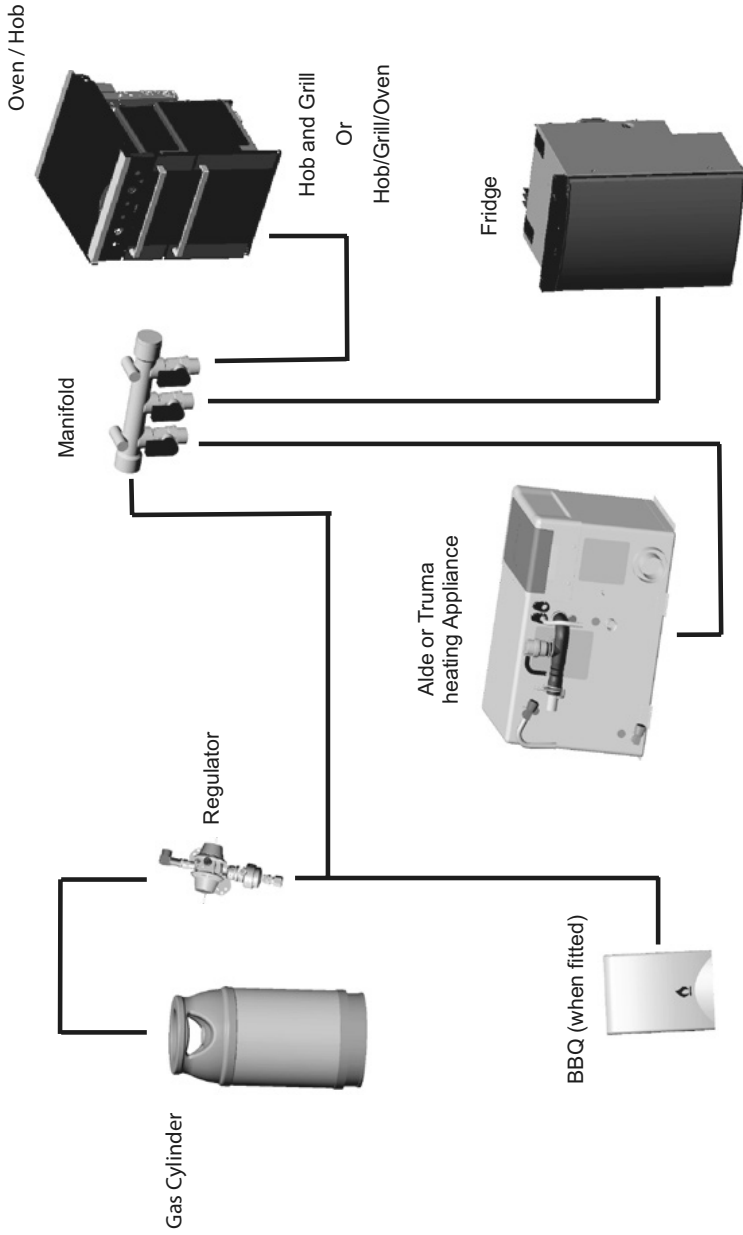

7.10 Gas

General information

Gas Cylinders

Bottled Liquefied Petroleum Gas (LPG) is the most convenient portable source of fuel for your vehicle.

The gas cylinder, cooking and heating appliances should be isolated when travelling unless your motorhome is fitted with en-route heating.

Regularly check flexible gas hose, joints and connections for tightness. Finally make sure that each gas appliance is working efficiently to the recommendations of the appliance manufacturers.

The LPG system should be inspected annually by a competent person.

Only use gas cylinders that are located within their dedicated position within the gas bottle housing, never extend the hose - hose lengths must not exceed 400mm.

Your vehicle is supplied with a wall mounted gas regulator plumbed inside the gas bottle compartment. The regulator and all appliances work at a harmonised 30mb pressure, which work with Butane and Propane gas.

Pressure regulation system in this vehicle has a fixed working pressure of 30 mbar with a flow rate of 1.5 kg/H and complies with the requirements of EN 12864 annex D.

We do not recommend the use of an inline LPG BBQ with the 1.5kg/H regulator when other LPG appliances are in use.

Motorhomes with external barbeque point

Models equipped with an external barbeque point can be used to power any gas appliance suitable for the gas used in the motorhome, at the working pressure shown on the label in the barbeque outlet box. Please note when using the outlet that the fitted regulator will allow a maximum of 1.5kg per hour of gas to be taken from the gas bottle. Therefore the consumption of gas from both the appliances within the motorhome and the appliance connected to the barbeque point cannot exceed a total of 1.5kg per hour at any one time. If you are in any doubt please consult your dealer for advice. To use the barbeque point proceed as follows:

1. Fit male tail connector from despatch kit to your barbeque or appliance ensuring a gas tight joint. The work should be carried out by a competent person; if in any doubt consult your dealer.
2. Open box lid by pulling tab on bottom edge and lifting, while pressing on centre of flap.
3. Insert tail connector on appliance into female coupling, twist to engage and lock.
4. Open gas locker on motorhome, ensure gas bottle tap is open and supply is connected to regulator.
5. Light and operate appliance to its instructions.

Please note that you cannot open the gas supply until the nozzle has been inserted. In the interest of safety all external hose lengths should be kept to a minimum and attachments secured correctly.

⚠ WARNING: Care should be taken when using the external barbeque point. Never barbeque next to an awning or tent.

⚠ WARNING: The motorhome barbeque point should only be used as an outlet point for gas, never connect a gas bottle direct to the outlet.

⚠ WARNING: Unless en-route heating is in use the LPG cylinder valve should be closed when driving.

⚠ WARNING: Switch off all gas appliances when driving unless the motorhome has an en-route heating regulator fitted

Gas Hoses

High-pressure hoses or pigtails as they are called must be used with the new style regulator.

High-pressure hoses incorporate a safety shut off valve for the use of the en-route heating system.

LPG cylinder i.e. Propane, Butane, BP and Camping Gaz cylinders all have unique bottle adaptor connections.

It is important to check you have the correct hose and adaptor to suit your gas cylinders.

Push on hoses are no longer permitted under the latest regulations.

The new high-pressure hoses have threaded connections and must be securely attached to the regulator and to the gas cylinder.

The hose connection to the pressure regulator relies upon a sealing washer(s) to maintain a gas tight joint, and it is essential to check that the washer is present, sound and correctly positioned prior to making the connection.

The gas cylinder connection relies on a metal seating or bull nose connection to obtain a gas tight joint, therefore it is essential that the mating surfaces are clean and undamaged. In no case should a damaged valve or connection be used.

Ensure that there is a constant rise in the flexible gas hose between the gas cylinder outlet and the regulator elbow.

⚠ WARNING: Inspect flexible gas hose(s) regularly for deterioration and renew as necessary with the approved type, in any case no later than 5 years after the date of manufacture marked on the hose. When replacing the en-route hose ensure the new hose incorporates a safety shut off valve (Hose rupture protection).

⚠ WARNING: Ensure that the high pressure hose is not excessively twisted or under stress when connected to the LPG cylinders and regulator.

⚠ WARNING: Always ensure the gas supply is isolated at the LPG cylinder (and not at the regulator) whilst the vehicle is in storage for any period. It is important to ensure that the high pressure gas hose has a continuous rise from the bottle cylinder to the regulation to allow any condensate to fall back into the gas bottle cylinder.

Cylinder compartment

All cylinder compartments have four plastic mouldings per cylinder position fitted to the floor of the compartment that are designed to fit both steel and BP Gas Light cylinders. Two straps are provided for retaining the bodies of the cylinders at mid to high level.

7.11 Types of gas

Propane

Propane is supplied in red, or partly red cylinders which have a female left hand threaded connector.

Scandinavian countries use the same connector.

Germany and Austria supply propane with a male connection.

Propane will work at temperatures as low as -40°C and is therefore suitable for all winter motorhoming.

ⓘ Note: Swift recommend that 6kg Calor propane cylinders are used (except Ascari which can hold 3.9kg propane cylinders). However the cylinder compartments can also house various cylinders dependant on model.

Escape / Kon-Tiki / Voyager 5 series (excludes 574) - (1 x 6kg + 1 x 13kg)

Voyager 4 Series / Voyager 574 - (2 x 6kg)

Ascari 344 / 372 - (2 x 3.9kg)

Ascari 384 - (2 x 6kg)

Butane

Butane is supplied in the U.K. in green or blue cylinders.

All these have a male left hand thread

EXCEPT for Camping Gaz which has a special female right hand thread and Calor 7kg and 15kg and aluminium bottles which have a special clip-on connection.

Continental cylinders usually have a male left hand thread similar to but not identical with U.K. butane.

Butane is only suitable for use at temperatures down to 2°C and will not work below that.

ⓘ Note: If an en-route heating regulator is fitted, a hose suitable for use with propane will have been supplied with your motorhome.

7.12 En-route heating (where fitted)

If your motorhome is equipped with an LPG en-route heating system, it comes installed with additional safety features:

Heating indicator

When present, an LED mounted close to the windscreen of the motorhome will indicate when the heating system is active. The heating system must not be active when entering a re-fuelling station / petrol station.

⚠ WARNING: Before re-fuelling your motorhome switch off the heater and close the gas cylinder valve.

Safety features

- MonoControl CS regulator or DuoControl CS regulator on some models incorporating a crash sensor which stops the gas flow in the event of the motorhome being involved in a traffic collision.
- Gas flow monitor
- Hose rupture protection is installed.
- The full system is Homologated in compliance with UN ECE regulation 122

Operating instructions

1. Open cylinder valve
2. Firmly press the hose rupture protection (green button) on the high pressure hose for about 5 seconds (fig 1 item 1)
3. If the Yellow reset button (fig 2, item 7) is not pressed ("not ready for operation" position), reset the crash sensor. To reset, press the Yellow reset button (fig 2, item 7) firmly turn it slightly clock-wise, hold it for 5 seconds and ensure that it stays in the "ready for operation" position (figure 2). If the re-set is not successful, use the Torx (T20) screw aid (fig 3, item 12) to support the clockwise rotation.

ⓘ Note: The regulator should be replaced no more than ten years after manufacture.

Changing a gas cylinder

Please use the correct size spanner for the gas hose connectors as this will prevent damage to the screw fittings and ensure that the fitting is tightened sufficiently. Also ensure that the replacement gas cylinder is of the correct type & size.

- Turn off all gas appliances
 - Close the empty gas cylinder's valve
 - Remove the high pressure hose from the gas cylinder.
 - Attach the high pressure hose to the full gas cylinder.
 - Open the full cylinder's valve.
 - Press the hose-break safety device
- Check the hose connection to the cylinder valve for leaks.

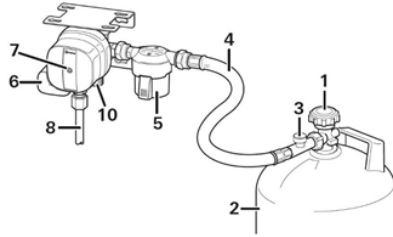

Fig. 1



Fig. 2

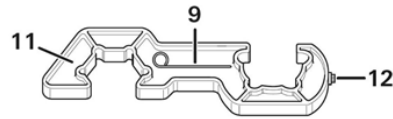

Fig. 3

⚠ WARNING: To ensure the safe working of the en-route heating any replacement high pressure hoses must be of the same type as originally fitted. They must have the safety valve to ensure that the gas does not leak out in the event of damage to the gas pipe work in the event of a traffic collision.

⚠ WARNING: When travelling using the en-route system all other LPG appliance shut off valves must be in the closed position including the fridge, cooker, water heater etc.

ⓘ Note: It is dangerous and illegal to operate other LPG appliances whilst travelling.

⚠ WARNING: Never allow modifications or repairs of electrical or LPG systems and appliances except by qualified persons.

⚠ WARNING: When leaving the motorhome for any period of time or storage always turn off the gas at the gas cylinder.

7.13 Gas safety advice

⚠ WARNING: If you smell gas or suspect a leak or in the event of a fire and if it is safe to do so, isolate the gas appliances and turn off the gas bottles at the regulator. Evacuate the motorhome and ventilate. Seek professional advice as to the cause of the leak.

Facts about LPG

LPG is not poisonous.

- Bi-products are harmless.
- There is danger if all air and oxygen were excluded.
- (Ventilation holes must be kept clear at all times).
- LPG has been given a smell by the manufacturers in order to identify leaks.

Awning Spaces LPG Appliance Exhaust

There is no danger of pollution of an enclosed awning space by the LPG exhaust from a refrigerator venting into it, as awning spaces are generally well ventilated.

Space heaters may produce sufficient exhaust to pollute the awning space, if it is totally enclosed, from a general comfort, smell and hygiene point of view. In the extreme case there could be a build up of carbon dioxide to a dangerous level.

Motorhome owners are advised to allow some fresh air circulation in the awning space when such appliances are in use.

General Safety Notes

In the event of leaks in the gas system or if there is a smell of gas:

- Extinguish all naked flames.
- Do not smoke.
- Switch off the appliance and gas cylinder.
- Open the windows.
- Do not operate any electrical switches.
- Have the entire system checked by an expert.

Precautions

- Never look for a leak with a flame. Always use a soap solution or its equivalent when testing connections. Do not operate any electrical apparatus whatsoever, especially light switches. If the leak is not obvious, the motorhome should be evacuated and qualified personnel consulted.
- Avoid naked lights when connecting or changing a cylinder.
- Check the flexible hose frequently.
- The gas is heavier than air and therefore sinks to the lowest point.
- Keep bottle gas containers outside (and protected against frost). If they must be kept inside make sure they are well away from heat.

⚠ WARNING: Do not use appliances with a different working pressure to 30mbar.

⚠ WARNING: Maintain adequate spacing of combustible materials from sources of heat.

⚠ WARNING: Do not use independent portable gas appliances inside the vehicle. Cookers shall not be used as heaters.

⚠ WARNING: A BBQ point inlet valve, if fitted, must only be used for the connection of portable LPG appliances.

⚠ WARNING: Always read individual appliance instructions.

⚠ WARNING: If in doubt, ask for advice from a competent person.

Connection

Ensure that the gas regulator hose is correctly connected to the gas cylinder in gas bottle compartment and that the hose connection is tight.

Gas cylinders must be fully located, seated at the base of the bottles and restrained by the straps provided in the dedicated compartment position. Straps are positioned to suit 6kg, 7kg and 13kg bottles.









⚠ WARNING: If using cylinders other than those recommended, the user must ensure these are adequately supported, ventilation openings must not be obstructed and the cylinders must not cause damage to other fixtures and fittings located in the compartment.

Open ended gas hoses must always be protected from dirt and insects.

Before turning on the gas supply at the regulator, ensure that all gas operated equipment in the motorhome is turned off.

All gas equipment is supplied through a Gas Manifold System which has individual isolation taps for each appliance (Fig A), as follows:



 GB: GAS TAP 1448473	
NL: GASKRAAN - DE: GASHAHN FR: ROBINET GAS	
 YELLOW GB: HOB NL: KOOKPLAAT DE: KOCHER FR: CUISINIER	 WHITE GB: HEATER NL: VERWARMING DE: HEIZUNG FR: CHAUFFAGE
 GREEN GB: OVEN NL: OVEN DE: OFEN FR: FOUR	 RED GB: HOT WATER NL: WARM WATER DE: HESSES WASSER FR: EAU CHAUDE
 BLUE GB: FRIDGE NL: KOELKAST DE: KÜHLSCHRANK FR: FRIGO	 WHITE GB: COMBINATION BOILER NL: COMBIBOILER DE: KOMBINATIONSHHEIZUNG FR: CHAUFFAGE COMBINÉ
 GB: OPEN NL: OPEN DE: OFFEN FR: OUVERT	 GB: CLOSED NL: GESLOTEN DE: ZU FR: FERMÉE

Flue installations

All flue installations should be inspected once a year throughout their length for corrosion. Flues should be replaced if any sign of perforation is found. Ensure that the replacement is of an approved type.

Thermal insulation heating

Your motorhome has been designed to achieve a thermal insulation and heating level for specific climatic conditions when tested according to the procedure in EN1646-1.

See the motorhome technical book for the classification of your motorhome. All Swift Group motorhomes achieve a Grade 3 classification.

The classifications are as follows:

Grade 1

A motorhome with an average thermal transmittance (u) that does not exceed 1.7w/(m²k).

Grade 2

A motorhome with an average thermal transmittance (u) that does not exceed 1.7w/(m²k) and which can achieve an average temperature difference of at least 20°C between inside and outside temperatures when the outside temperature is 0°C.

Grade 3

A motorhome with an average thermal transmittance (u) that does not exceed 1.2w/(m²k) and which can achieve an average temperature difference of at least 35°C between inside and outside temperatures when the outside temperature is -15°C.

7.14 Gas fault finding

Fault	Cause	Remedy
Hob does not light	No gas Air in pipe	Check level of gas in cylinder Check gas cylinder valve is on Check gas taps are on Purge system Refer to hob manufacturers instructions
Oven does not light	No gas Air in pipe	Check level of gas in cylinder Check gas cylinder valve is on Check gas taps are on Purge system Refer to oven manufacturers instructions
BBQ does not light	No gas Over gassed Air in pipe	Check level of gas in cylinder Check gas cylinder valve is on Check gas taps are on Turn off appliance, wait 2 minutes and try again Purge system
Fridge does not light	No gas Air in pipe	Check level of gas in cylinder Check gas cylinder valve is on Check gas taps are on Purge system Refer to fridge manufacturers instructions
Combination Heater does not light	No gas Air in pipe	Check level of gas in cylinder Check gas cylinder valve is on Check gas taps are on Purge system Refer to water heater manufacturers instructions

7.15 The electrical system

General Information

It is strongly advised that the mains installation is inspected periodically to ensure safe use. The IET (BS7671) wiring regulations recommend that mains installations in motorhomes are re-inspected every 3 years or annually if the van is used frequently. The National Caravan Council lists the qualifications necessary to perform this inspection, but an NICEIC approved contractor is probably the first choice.

On arrival at the campsite

- Check the suitability of the supply, is it AC or DC, is the voltage and frequency correct.
- Ensure that there is a proper earth (3 pin socket outlet).
- If in doubt consult site staff.
- Make sure that the supply from the site is switched off.
- Make sure that the charger switch on the PSU is switched off.
- Lift the cover on the electricity inlet on the motorhome, and insert the connector on the flexible supply cable.
- At the site supply point, connect the other end of the supply cable to this using the socket provided.
- Switch on the main switch at the site supply point.

ⓘ Note: It is good practice to test the RCD (Residual Current Device) in the PSU before switching on. There is a test button on the RCD. To test the lever, put the lever in the up position (on) before testing.

ⓘ Note: As with the RCD it is good practice to check the Miniture Circuit Breaker (MCB) in the PSU. Switch all to the on position (lever up). If any do not stay up then there is a fault.

On departure from the campsite

- Switch off supply from the site, disconnect the cable at both ends.
- Switch off RCD.

ⓘ Note: Never use a mains supply lead whilst coiled. Always uncoil the full length before connecting to the supply and remember to protect the cable from traffic.

⚠ WARNING: Current consumption in the motorhome must not exceed 16 amps or the pitch permitted maximum if this is less than 16 amps.

Overseas connection

- Connection to a mains voltage overseas requires particular attention.
- Overseas supplies can be of reverse polarity.
- Reverse polarity results in equipment not necessarily being isolated when turned off, reverse polarity indicator on the PSU will light in the event of reverse polarity.
- The only sure way to make equipment safe is to unplug it.
- It is useful to have a means of checking polarity when overseas.
- If it can be achieved then connect live to live, and neutral to neutral to achieve full electrical protection.

⚠ WARNING: Never allow modifications or repairs of electrical or LPG systems and appliances except by qualified persons.

7.16 230V mains electrical equipment power consumption

Please note: It is possible that the 230v mains electrical equipment may not all operate simultaneously. A typical UK site mains hook up point provides a maximum output of 10 amps and on some continental sites the available output may be as low as 5 amps. If your loading exceeds the site supply it may trip the site circuit breaker. Please check the available mains supply with your site operator.

Similarly loadings on each circuit breaker within the motorhome should be observed. A label positioned close to the MCB's (Miniture Circuit Breakers) will identify which appliances within the motorhome are fed from which MCB. Consulting the typical appliance consumption figures table in conjunction with this label, will give an indication of which appliances can, and cannot, (site supply allowing), be operated simultaneously.

7.17 Wiring of connecting cable and motorhome mains inlet

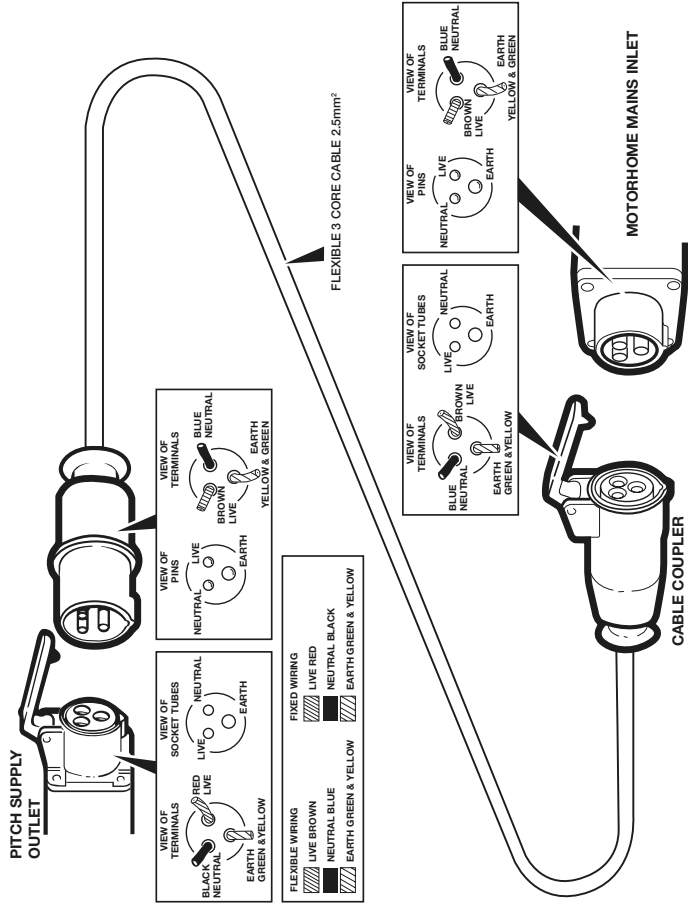

The legal length of the mains inlet cable is 25 ± 2 metres. When in use it must be fully uncoiled and protected from traffic.

7.18 Typical appliance consumption figures

Appliance/ Item	230 Volt		12 Volt		LP Gas grams/hour
	Watts	Amperes	Watts	Amperes	
Domestic Refrigerator	190 W	0.8 amp	Only when driving		16 g/h
Truma Combi 4kw Heating System	900 / 1800 W	3.9 / 7.8 amp	13 w	1.1 amp (avg)	320 g/h
Truma Combi 6kw Heating System	900 / 1800 W	3.9 / 7.8 amp	13 w	Up to 6.5 amps	480 g/h
Alde Heating System	1050 / 2100 / 3150 W	4.6 / 9.1 / 13.7 amp	Up to 23w	Up to 1.9 amps	245 - 460 g/h
Microwave (Factory fit)	Up to 1270w	Up to 5.5 amp		Not Applicable	Not Applicable
Cooker - Hob burners	Not applicable			Not applicable	70 – 161 g/h each
Cooker – Electric Hotplate	800 w	3.5 amp		Not applicable	Not applicable
Grill	Not applicable		0 - 14.4w (Cooling fan)	0 - 1.2amp (Cooling fan)	117 g/h
Oven	Not applicable		0 - 14.4w (Cooling fan)	0 - 1.2amp (Cooling fan)	125 – 146 g/h
Battery Charger	690 W	3.0 amp		Not applicable	Not applicable
Omnivent	Not applicable		2 w – 30 w	0.2 amp – 2.5 amp	Not applicable
Powered bed mechanism	Not applicable		Max 240w	Max 20amp	Not applicable
Powered table mechanism	Not applicable		Up to 63w	Up to 5amps	Not applicable
12v LED lights (each, depending in size of light)	Not applicable		0.4w - 6.1w	0.05 amp – 0.5 amp	Not applicable
USB socket or USB charging socket within light	Not applicable		Up to 18w	Up to 1.5 amps	Not applicable
Water tank frost element (Winter pack)	Not applicable		30 W	2.5 amp each	Not applicable

Note: These are approximate figures for guidance only, and are subject to changes in specification. The figures show energy consumption when an item or appliance is operating – i.e. a light is illuminated, or a heating system is providing space heating or water heating. Appliances which feature LCD or illuminated control panels can have a low current consumption when in stand by mode, or have a constant low current draw in the background to run their displays and electronic systems - these figures are typically 0.4 amps or less, for each applicable item. These electronic items can in most cases be switched off individually, or, use of the System Shutdown button on the power supply unit isolates all of these items.

8. Electrics

8.1 EC400+ Motorhome Power Control System (Ascari & Voyager)	70
8.2 Using the System	71
8.3 EC400+ Control Panel Component Layout	72
8.4 System Warnings	74
8.5 System Technical Information	77
8.6 Common Fault Table	82
8.7 Technical Data	85
8.8 Approvals	86
8.9 EC940 Motorhome Power Control System (Escape)	87
8.10 Using the System	87
8.11 Control Panel - Layout	89
8.12 System Warnings	95
8.13 System Technical Information	98
8.14 Common Fault Table	102
8.15 Technical Data & Approvals	104
8.16 Approvals	105
8.17 Swift Command Power Control System (Kon-Tiki)	107
8.18 Using the System	107
8.19 System Technical Information	122
8.20 Common Fault Table	126
8.21 Technical Data & Approvals	130
8.22 Approvals	131
8.23 Motorhome battery	132
8.24 Solar panel	135
8.25 Accessory harnessing	136
8.26 Generator usage	137
8.27 Habitation relay	137
8.28 Fault Finding	138

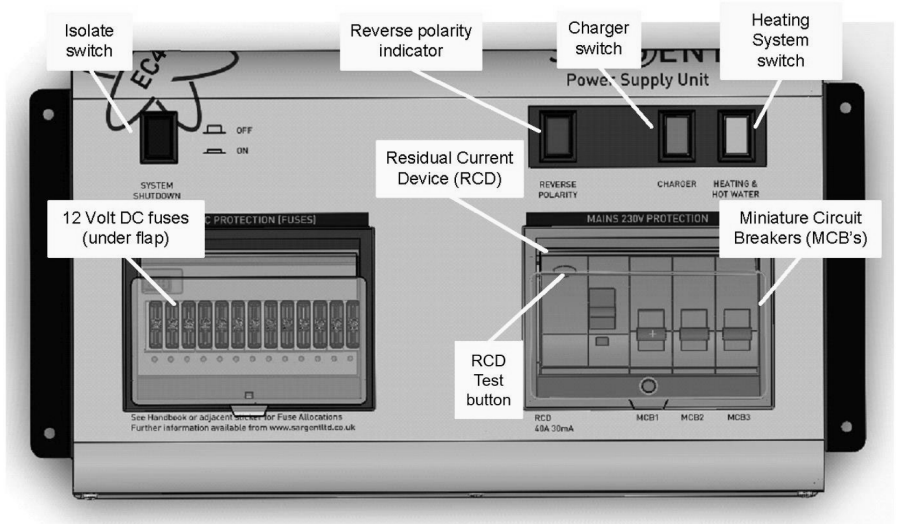

8.1 EC400+ Motorhome Power Control System (Ascari & Voyager)

1. Introduction

This section of the handbook will guide you through the operation of the electrical system. All details are correct at the time of going to press. Please also see the online version which will include any later updates or amendments.

Further technical details are contained in section 3 or in the supporting technical manual available from www.sargentltd.co.uk

For the safe operation of all electrical equipment within your Leisure Vehicle it is important that you read and fully understand these instructions. If you are unsure of any point, please contact your dealer / distributor for advice before use.

The system has a number of key components that you will need to be familiar with before attempting to use the system, these are:

- The EC454PSU or EC456PSU Power Supply Unit - a combined mains consumer unit and 12V controller usually located in a storage area (lower bed box, wardrobe or similar).
- The EC463 Control Panel - a remotely located user control panel used to turn circuits on and off and to display battery, water tank and other system information.
- The PX300 Intelligent 300W Battery charger.

8.2 Using the System

Power Supply Unit - Component Layout (see image on previous page)

The PSU is located in the front offside bed box area.

Activating the System

The system has a shutdown feature that can be used when the vehicle is in storage. This allows the leisure electronics to be turned off when not required to save battery power. When in the off state the alarm and tracking system supplies are still active, all other supplies are turned off.

Before using the system, please ensure the system shutdown switch is in the on position (button in) the system is now active.

Connecting to the Mains 230V supply and Safety checks

For your safety it is IMPORTANT that you follow these connections instructions each time your Leisure Vehicle is connected to a mains supply. This section assumes that the system is complete and that a Leisure battery has been installed (see 3.4).

A) Ensure suitability of the Mains Supply.

Your Leisure Vehicle should only be connected to an approved supply that meets the requirements of BS7671 or relevant harmonised standards. In most cases the site warden will hold information regarding suitability of supply. If using a generator, you also need to comply with the requirements / instructions supplied with the generator. Please note that some electronic generators may not be compatible with your leisure system. Further generator operational information is contained on page 78.

B) Switch the PSU Battery Charger / Power Converter OFF.

Locate the green 'Charger' power switch on the PSU and ensure the switch is in the off position (button out) before connection to the mains supply.

C) Connect the Hook-up Lead.

Firstly, connect the supplied hook-up lead (orange cable with blue connectors) to the Leisure Vehicle and then connect to the mains supply.

D) Check Residual Current Device operation.

Locate the RCD within the PSU and ensure the RCD is switched on (lever in up position). Press the 'Test' button and confirm that the RCD turns off (lever in down position). Switch the RCD back to the on position (lever in up position). If the test button failed to operate the RCD see section 3.1.

E) Check Miniature Circuit Breakers

Locate the MCB's within the PSU (adjacent to the RCD) and ensure they are all in the on (up) position. If any MCB's fail to 'latch' in the on position see section 3.1.

F) Turn the PSU ON.

Locate the black 'Shutdown' button and ensure it is in the on position (press button in). Locate the green 'Charger' switch on the PSU and turn to the on position (press button in). The charger switch will illuminate when turned on.

G) Check correct Polarity.

Locate the 'Reverse polarity' indicator on the PSU and ensure that the indicator is NOT illuminated. If the indicator is illuminated see section 3.2.

H) Check operation of equipment.

It is now safe to operate the 12V and 230V equipment.

Operation while driving

The power control system is designed to shutdown parts of the system while the engine is running. This is to meet Electro Magnetic Compatibility (EMC) regulations and to ensure the safe operation of the motorhome. With the engine running the control panel will flash the leisure battery and vehicle battery LEDs to indicate that the batteries are being charged.

Please ensure the system shutdown switch on the PSU is in the on (button in) position before driving (see 2.2). This will ensure the electronic system is active and will therefore be able to control the charging process, supply the refrigerator and monitor other system circuits.

If / when fitted, designated 12V sockets, en-route reading lights and en-route heating will remain operational while the engine is running.

8.3 EC400 + Control Panel Component



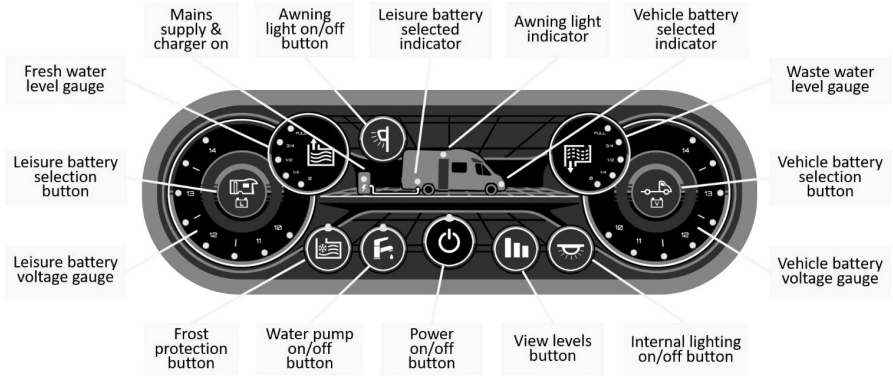

Layout







Your control panel will have an appearance as below, but depending on your specification of the vehicle the control panel features will vary. Not all features are present in all vehicles.



EC463 Control Panel

Control Panel - Key Features

	<p>Power Button. Press the power button to turn the leisure power on. Press the button again to turn the power off. The adjacent indicator will illuminate when the power is on, and also the voltage of the selected battery will be displayed on the voltage gauge.</p>
	<p>Pump Button. With the power on, press the pump button to turn the water pump on. Press the button again to turn the pump off. The adjacent indicator will illuminate when the pump is on, and also the level of the water tank will be displayed on the water gauge (if a tank with level sensor is fitted)</p>
	<p>View Levels Button. To display the battery voltage levels and the water tank levels on the control panel gauges, press the levels button. The display will remain illuminated for 10 seconds. It is possible to lock the display 'on' to allow continuous display. This can be achieved by pressing and holding the view levels button for 2-3 seconds until you hear a beep. To turn this locked feature off, either press and hold the view levels button again for 2-3 seconds or turn the power off and back on.</p>
	<p>Leisure Battery Button. To select the Leisure battery as the source of power, press the leisure battery select button. The Leisure battery indicator with then illuminate, confirming the selected battery. Note: By default, the leisure battery is selected as the source of power (if no mains supply is available), or as the battery to be charged (when a mains supply is available).</p>

	<p>Vehicle Battery Button. To select the Vehicle battery as the source of power, press the vehicle battery select button. The Vehicle battery indicator will then illuminate, confirming the selected battery.</p>
	<p>Mains On Indicator. When connected to a 230V supply and the battery charger is turned on this indicator will illuminate.</p>
	<p>Charging when the vehicle engine is running. When the vehicle engine is running both the vehicle battery and the leisure battery indicators will flash in unison to indicate that they are connected together and are being charged by the vehicle.</p>
	<p>Internal Lights Button. With the power on, press the internal lights button to turn the main lighting supply on or off.</p>
	<p>Awning Light Button. With the power on, press the awning light button to turn the awning light on or off.</p>
	<p>Frost Protection Button (if fitted). With the power on, press the frost protect button to turn on the water tank heating system. The adjacent indicator will illuminate to show that the tank heating system is on.</p>

Further information relating to the control panel features can be found in the following sections.

8.4 System Warnings

The system incorporates a number of warnings that are active at specific times. These are summarised below, and also covered by relevant sections of this manual.

When a warning is active a warning box will appear on the control panel screen containing a description of the warning along with an audible beeping sound.

Warning	When	Type
Fresh water level low	With pump turned on and fresh water level low (less than 25% full) Only available when an on-board tank is fitted	Audible beep and the Fresh gauge empty indicator will flash (To cancel press Levels Button)
Waste water level full	With pump turned on and waste water level full. Only available when an on-board tank is fitted	Audible beep and the Waste gauge empty indicator will flash (To cancel press Levels Button)
Leisure battery voltage low	With control panel power on and leisure battery selected (as active battery) and the voltage level falls below 10V	Audible beep and the Leisure battery gauge 10V indicator will flash (To cancel press Levels Button)
	With control panel power on and leisure battery selected (as active battery) and the voltage level is below 9V	Audible beep and Leisure battery gauge 10V indicator will flash. If the warning is not cancelled the control panel will be turned off. (To cancel press Levels Button)
	<p>Note: This is an emergency cut off level to protect the battery from severe damage. You should not rely on this cut off level during normal operation, but manage your power consumption to a discharge level of 11.5V or above.</p> <p>This cut off only applies to power drawn from the battery by the leisure equipment that is controlled by the control panel power switch; it will not protect the battery from discharge by permanently connected equipment.</p>	
Leisure battery voltage high	With control panel power on or off and leisure battery is selected (as active battery) and the voltage level rises above 15V	Audible beep, the Leisure battery gauge 14V indicator will flash, and the control panel power will be turned off. (To cancel remove the high voltage source)

Warning	When	Type
Vehicle battery warnings	If the vehicle battery is selected instead of the leisure battery, then similar warnings to those described above are applied to the vehicle battery. The vehicle battery low warning level is 10.9V	
Vehicle battery warnings	If the vehicle battery is selected instead of the leisure battery, then similar warnings to those described above are applied to the vehicle battery. The vehicle battery low warning level is 10.9V	
Engine running	When the engine is started the system power will be turned off	
Engine running, Step extended	Step extended and engine started	Short warning beeps before the step is automatically retracted
	Step jammed or obstructed	Continuous warning beeps
Engine running, Mains lead (hook-up cable) still connected / plugged in	When the engine is started and the mains cable is still plugged in and the charger is switched on	Continuous warning beeps

Water System Operation

The control panel pump button operates the internal (onboard) water pump.

The system also incorporates a separate powered water inlet that can be used with an external filler pump to fill the internal (onboard) water tank.

The water tanks (fresh & waste) incorporate a level warning feature to warn the user when the fresh water level drops below 25% or when the waste water level reaches 100%.

If the water pump power is turned on and the fresh water level drops to below 25% a warning beep will be heard and the fresh gauge empty indicator will flash. To cancel the warning, press the levels button.

If the water pump power is turned on and the waste water level rises to full (100%) a warning beep will be heard and the waste gauge full indicator will flash. To cancel the warning, press the levels button.

These warnings will not be repeated unless the water pump power switch is turned off and on again. This is to ensure the warning does not become a nuisance.

Frost Protection Operation (where fitted)

On vehicles fitted with water tank frost protection, the control panel frost protect switch can be used to turn the feature on or off.

With protection on, the system monitors the external temperature and will control the tank heaters accordingly. The heaters will switch on at 4-5 Deg C and off at 8-10 Deg C. If the fresh or waste water levels are less than 25% the appropriate heater will be turned off to prevent overheating or damage to the element.

Solar Charge Management (where fitted)

The Power Supply Unit incorporates a built-in solar charge management feature, which will control the input from a separate solar panel and regulator. Depending on the charge state of the batteries, the solar power will be directed to the required battery, and continuously monitored to ensure optimum operation. For this system to operate intelligently, the shutdown button should be left switched on. If the shutdown button is turned off then the solar panel will charge the vehicle battery only.

Smart Charging

The Power Supply Unit incorporates a smart charge feature, which monitors both leisure and vehicle batteries and automatically adjusts and directs the charger power (and solar power if a solar panel is installed) to maintain the leisure and vehicle batteries at an optimal level.

Note: If the vehicle battery is isolated using the Fiat ignition key isolator or similar, some smart charging functionality will be lost, and the available charge will be directed to the leisure battery.

Electric Step Operation (where fitted)

On vehicles fitted with an electric step, this is operated by a button near the entry door. Press and release the button to move the step in or out. One press of the button will move the step out; a further press will move the step in again.

If the engine is started the step will move in automatically, after a short warning buzzer. If this operation fails due to an obstacle a buzzer will sound continuously to warn that the step is still out, and therefore requires your attention.

8.5 System Technical Information

The following section provides further technical information relating to the electrical system. You can also access the supporting technical manual from www.sargentltd.co.uk

Residual Current Device & Miniature Circuit Breakers

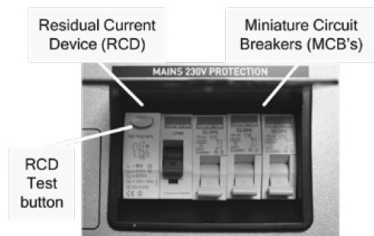

The Residual Current Device (RCD) is basically provided to protect the user from lethal electric shock. The RCD will turn off (trip) if the current flowing in the live conductor does not fully return down the neutral conductor, i.e. some current is passing through a person down to earth or through a faulty appliance.

To ensure the RCD is working correctly, the test button should be operated each time the vehicle is connected to the mains supply (see section 2.3)

The Miniature Circuit Breakers (MCB's) operate in a similar way to traditional fuses and are provided to protect the wiring installation from overload or short circuit. If an overload occurs the MCB will switch off the supply. If this occurs you should investigate the cause of the fault before switching the MCB back on.

The following table shows the rating and circuit allocation for the three MCB's

MCB	Rating	Output Wire Colour	Description
1	10 Amps	White	230V Sockets
2	16 Amps	White (Yellow for heater)	Extra 230V Sockets / Heating System
3	10 Amps	Black (Blue for Whale water heater)	Fridge / Charger / Auxiliary devices / Whale Water Heater

Generator Usage

Caution should be used before connecting a generator to your motorhome.

⚠ WARNING: Never start or stop the generator while electrical loads are connected and switched on. Start the engine, let it stabilise and then connect the electrical load. When stopping the generator, disconnect the electrical load and let engine stabilise before switching off.

Whilst some generators use electronic inverter technology, others use a more basic principle to generate the 230V supply. Preference should be to choose a generator which produces a consistent sinusoidal wave form with accurate voltage control.

The Reverse Polarity warning light on the PSU may illuminate when using a Generator. This is a normal side effect when using some types of generator. Instead of connecting the neutral conductor to earth, some generators centre-tap the earth connection making both neutral and live conductors 110V above earth. This 110V difference causes the neon polarity indicator to illuminate.

In most cases it is safe to use a generator, but please consult the generator handbook for further information.

Battery Charger

The system incorporates an intelligent three-stage battery charger.

During stage 1 the battery voltage is increased gradually while the current is limited to start the charging process and protect the battery. At stage 2 the voltage rises to 14.4V to deliver the bulk charge to the battery. When the battery is charged, the voltage is decreased at stage 3 to 13.6V to deliver a float charge to maintain the battery in the fully charged state. The charger can be left switched on continuously as required.

The battery charger / power converter also provides power to the leisure equipment when the mains supply is connected. This module supplies DC to the leisure equipment up to a maximum of 25 Amps (300 Watts), therefore the available power is distributed between the leisure load and the battery, with the leisure load taking priority as per the following example:

Leisure Load	Available power for battery charging
5A	20A
10A	15A
15A	10A
20A	5A

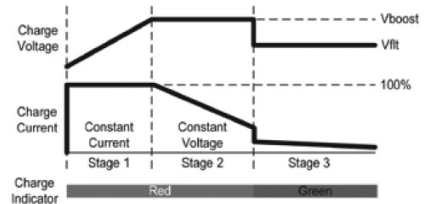

⚠ WARNING: Under heavy loads the Battery Charger case may become hot. ALWAYS ensure the ventilation slots have a clear flow of air. Do not place combustible materials against / adjacent to the charger.

Leisure Battery

A) Type / Selection

For optimum performance and safety, it is essential that only a proprietary brand LEISURE battery is used and it is suggested to select a battery from the NCC Verified Battery Scheme with a typical capacity of 75 to 120 Ah (Ampere / hours). Depending on the prospective use of the vehicle, the correct type should be selected (A, B or C, according to the NCC Verified Battery Scheme). A normal car battery is NOT suitable. This battery should always be connected when the system is in use.

The PSU is configured to work with standard lead acid leisure batteries, and in most cases is also compatible with the latest range of Absorbed Glass Matt (AGM) batteries. The system is also suitable for Lithium batteries with built-in Battery Management Systems BMS. Before fitting non-standard batteries, please check that the charging profile described in 3.3 is suitable for the type of battery by referring to the battery documentation or battery manufacturer.

Some vehicle installations can cater for two leisure batteries connected in parallel. In these cases, it is recommended that two identical batteries are used.

The battery feed is fitted with an inline fuse between the battery and the electrical harness, and is usually located immediately outside the battery compartment or within 500mm of the battery. The maximum rating of this fuse is 40A per battery.

B) Installation & Removal

Always disconnect the 230V mains supply and turn the PSU green charger switch to the

off position (button out) before removing or installing the battery.

When connecting the battery, ensure that the correct polarity is observed (black is negative [-] and red is positive [+]) and that the terminals are securely fastened. Crocodile clips must not be used.

⚠ WARNING: Explosive gases may be present at the battery. Take care to prevent flames and sparks in the vicinity of the battery and do not smoke.

C) Operation / Servicing

Under normal circumstances it should not be necessary to remove the battery other than for routine inspection of the terminals and "topping up" of the battery fluid where applicable. Please see instructions supplied with the battery.

ⓘ Note: Do not over discharge the battery. One of the most common causes of battery failure is when the battery is discharged below the recommended level of approximately 10V. Discharging a battery below this figure can cause permanent damage to one or more of the cells within the battery.

To prevent over discharge, the power control system incorporates a battery protect circuit that warns the users and then disconnects the batteries when they fall below set values.

If a warning is active a beep will be emitted by the control panel. To cancel the warning, press the Levels Button. These warnings will not be repeated unless the power switch is turned off and on again. This is to ensure the warning does not become a nuisance.

Battery	Voltage cut off	Action after cut off	Notes
Vehicle	10.9V	Battery selection is changed from Vehicle battery to Leisure battery. If the leisure battery is below 9V then a further warning will occur (see below).	This cut off level is designed to protect the vehicle battery from over discharge. The 10.9V level ensures there is sufficient power in the battery to run the vehicle electronics and start the vehicle. This cut off only applies to power drawn from the battery by the leisure equipment; it will not protect the battery if you leave vehicle circuits switched on, such as the road lights.
Leisure	9V	Power is turned off	<p>This is an emergency cut off level to protect the battery from severe damage. You should not rely on this cut off level during normal operation, but manage your power consumption to a discharge level of about 11.5V.</p> <p>This cut off only applies to power drawn from the battery by the leisure equipment that is controlled by the control panel power switch; it will not protect the battery from discharge by permanently connected equipment.</p>

12 Volt DC Fuses

⚠ WARNING: When replacing fuses always replace a fuse with the correct value. NEVER replace with a higher value / rating as this could damage the wiring harness. If a replacement fuse 'blows' do not keep replacing the fuse as you could damage the wiring harness. Please investigate the fault and contact your dealer.

The following table shows the fuse allocation for the 13 fuses fitted to the PSU. Please note that fuses are dependant on PSU versions, so not all fuses may be present.

Fuse	Rating	Fuse Colour	Description
1	25 Amps	White	Battery Charger
2	7.5 Amps	Brown	Fridge Controls / Alarm
3	10 Amps	Red	12V & USB Sockets / TV Amp
4	10 Amps	Red	Extractor, Cooker hood, Heki powered skylight. Alde or Truma Combi Heating (Not En-Route), Whale Water Heater
5	10 Amps	Red	Appliances, Cooker, Toilet, Whale Space Heater, Locker Mount USB, Tank Valves
6	10 Amps	Red	Water Pumps / Tank Heaters
7	7.5 Amps	Brown	Main lighting (not including spotlights with USB), Rear ambient lighting, Offside awning light
8	7.5 Amps	Brown	Entry lights, Front ambient lighting
9	10 Amps	Red	Alde or Truma En-Route Heating, Marker Lights, En-Route lighting, 12V Sockets, WiFi & Satellite supply
10	10 Amps	Red	Awning Light (Doorside) / Electric Step
11	15 Amps / 20 Amps	Blue/Yellow	Fridge 12V: 15A for undercounter fridge, 20A for tall fridge freezer
12	15 Amps	Blue	Towing 12V
13	15 Amps / 20 Amps	Blue/Yellow	Fridge D+: 15A for undercounter fridge, 20A for tall fridge freezer

ⓘ Note: Fuses (2-13) have a Red LED below them which provides indication that the fuse has blown. The charger fuse has a green LED which indicates that the charger is working.

Fuse	Rating	Fuse Colour	Description
Battery 1	40 Amps	Orange	Fuse remotely located near battery
Battery 2	40 Amps	Orange	Fuse remotely located near battery 2 (where fitted)

8.6 Common Fault Table

Fault	Possible Cause	Proposed Fix
No 230 Volt output from PSU	Connecting lead between the site and Leisure Vehicle not connected	Check and connect lead as per 2.3C
	RCD switched off	Reset RCD as per 2.3D
	RCD not operating correctly	Check supply polarity; if the RCD continues to fail contact your Dealer as there is probably an equipment or wiring fault.
	MCB switched off	Reset MCB by switching OFF (down position) then back ON (up position), if the MCB continues to fail contact your Dealer as there is probably an equipment or wiring fault.
	No or deficient supply from site	Contact site Warden for assistance.
	Another fault	Contact your Dealer
Reverse Polarity light is illuminated on PSU	Mains Supply reversed?	The reverse polarity light is designed to illuminate when the Live and Neutral supply has been reversed / crossed over. If the light illuminates there is a problem with the site supply or the cable connecting the supply to your vehicle. The light is designed to work on UK electrical supplies (where the neutral conductor is connected to earth at the substation). If you are using your vehicle outside the UK this light may illuminate when no fault exists. In these cases, consult the site warden for advice.
	Generator being used	'The Reverse Polarity warning light is on when using my Generator'. This is a normal side effect when using some types of generator. Instead of connecting the neutral conductor to earth, some generators centre-tap the earth connection making both neutral and live conductors 110V above earth. This 110V difference causes the neon polarity indicator to illuminate. In most cases it is still safe to use the generator, but please consult the generator handbook for further information.

Fault	Possible Cause	Proposed Fix
Control Panel Problems	Control Panel has no display	<p>Check batteries and fuses, turn PSU isolate switch and charger switch on and ensure mains supply is connected.</p> <p>Check control panel connecting lead at PSU and behind Control Panel.</p> <p>Contact your Dealer.</p>
	12V Power turns off	<p>Battery protect feature has operated to protect the Vehicle battery and or the Leisure battery. See 3.4C</p> <p>Over voltage protection has been activated, control panel is beeping, 14V LED is flashing (leisure or vehicle). A number of things can cause this but the most common is the solar panel, it is worth checking the regulator is connected correctly and operating within the correct parameters.</p> <p>Engine has been started; all equipment has been disconnected to meet EMC requirements. See 2.4</p>
	Control Panel locked / erratic function	<p>Observe control panel handling instructions.</p> <p>Control panel software may have crashed. Reboot control panel by turning off the PSU isolate switch. Wait 30 seconds then turn the switch back on. Check with your dealer that your system has the latest software installed, as an update may be available.</p>
No 12 volt output from PSU	No 230V supply	Check all above
	Charger not switched on	Turn charger switch on, switch will illuminate
	Battery not connected and / or charged	Install charged battery as per 3.4
	Power button on control panel not switched to on	Turn power on at control panel
	Battery flat / Battery fuse blown	Recharge battery, check fuses, check charging voltage is present at battery.
	Fuse blown	Check all fuses are intact and the correct value fuse is installed as per fuse table.
	Equipment switched off / unplugged	Check equipment is switched on and connected to the 12V supply
	Other fault	Contact your Dealer

Fault	Possible Cause	Proposed Fix
Pump not working	Fuse blown	Replace fuse with correct value as per fuse table
	Pump turned off	Turn pump on by pressing the pump button at the control panel
Lights not working	Fuse/s blown	Replace fuse with correct value as per fuse table.
	Lights turned off	Turn Lights on by pressing the lights button, use dimmer at the control panel.

Contact details

Sargent Electrical Services Limited provide a technical help line during office hours. Please contact 01482 678981 if you require technical help.

For out of hour support please refer to the support section of the Sargent web site www.sargentltd.co.uk

8.7 Technical Data

Equipment – EC652, EC653, EC800, EC635 & PX300

Outline Specification		
Input 230V	230 Volts / 0 to 16 Amps	+ / - 10%
Output 230V	RCD protected, 2 x MCB outputs of 10A & 1 x MCB output of 16A Separate switched channels for heating system and charger	
Input 12V	2 x 20A battery inputs via 2 x 4-way connectors	
Solar Input	1 x Dedicated solar panel input capable of supporting 10A of solar power input (typically 180 to 200W) via a 2-way connector	Check the solar panel rating plate to ensure the maximum current is $\leq 10A$
Output 12V	25A total output via multiple switched channels protected by 13 fused outputs	
Battery Charger	Input 220-240 Volts AC +/- 10%, Frequency 50 Hz +/- 6%, Current 3A max. DC Output 13.6 to 14.4 Volts nominal, Current 25 Amps max (300 Watts).	
Signal Input	4 x Fresh water level, 4 x Waste water level, 1 x Engine running, plus multiple vehicle connections, sensor inputs for temperature & humidity	Fresh water negative sensed Waste water negative sensed
Data In / Out	CANBUS Data communication and power to Control Panel via 6 way connector CI-Bus Data communication to CI-Bus enabled devices via RJ11/12 connector	
IP rating	IP31	
Operating temperature	Ambient 0 to 35° Celsius Charger case temperature with full load 65° C Max	Automatic shutdown and restart if overheated /overloaded
Dimensions		
EC454PSU, EC456PSU Power Supply Unit	Overall size (HxWxD) 180 x 305 x 135mm Clearances 75mm above, 50mm left & right	Weight 3.8 Kg
EC463 Control Panel	Overall size (HxWxD) 87 x 250 x 15mm Cut-out size (HxWa) 70 x 233mm	Fixing centres 130*75mm Weight 114 g

8.8 Approvals

System: BSEN 1648-1, BSEN1648-2 compliant, BS7671: 2018 compliant

Residual Current Device: RCD 40A 30mA trip to BS EN 61008

Miniature Circuit Breakers: MCB's type C 4500A breaking capacity to BSEN 60898

Electro Magnetic Compatibility (EMC) directive 2014/30/EU Certificate CE20071224-1

Battery Charger: BS EN 60335-2.29 CB, UL60950-1 Approved, IEC61000-4-2,3,3,4,5,6,8,11, EN55024, Light industry level, Criteria A, EN55022 (CISPR22) Class B, EN61000-3-2,3

Low Voltage Directive: 2014/35/EU TUV-014900-A1

Declaration of Conformity

Equipment: Leisure Power Control System

Model name: EC454, EC463 CP, EC652, EC643, EC800 CP & PX300

I hereby declare that the equipment named above has been designed to comply with the relevant sections of the above referenced approvals. The unit complies with all essential requirements of the Directives.

Signed	Name	Position	Manufacturer
	I L Sargent	Managing Director	Sargent Electrical Services Ltd Unit 35, Tokenspire Business Park Woodmansey, Beverley East Yorkshire, United Kingdom
Date: 25/08/2021			

Whilst every effort has been made to ensure the accuracy and completeness of this document, no guarantee is given against errors or omissions. This document may be updated / improved over time therefore please check with your dealer / supplier for update information or visit www.sargentltd.co.uk

8.9 EC940 Motorhome Power Control System (Escape)

This section of the handbook will guide you through the operation of the electrical system. All details are correct at the time of going to press. Please also see the online version which will include any later updates or amendments.

Further technical details are contained in section 8.13 or in the supporting technical manual available from www.sargentltd.co.uk

For the safe operation of all electrical equipment within your Leisure Vehicle it is important that you read and fully understand these instructions. If you are unsure of any point, please contact your dealer / distributor for advice before use.

The system has a number of key components that you will need to be familiar with before attempting to use the system, these are:

- The EC403PSU, EC454PSU or EC456PSU

Power Supply Unit (PSU) - a combined mains consumer unit and 12V controller usually located in a storage area (lower bed box, wardrobe or similar).

- The EC940 Control Panel (CP) - a remotely located user control panel used to turn circuits on and off and to display battery, water tank and other system information. This panel uses a graphical touchscreen with straightforward controls and reliable data communication to the PSU.
- The PX300 Intelligent Battery charger 300W.

8.10 Using the System

Power Supply Unit - Component Layout

The PSU is usually located in the front offside bed box area.

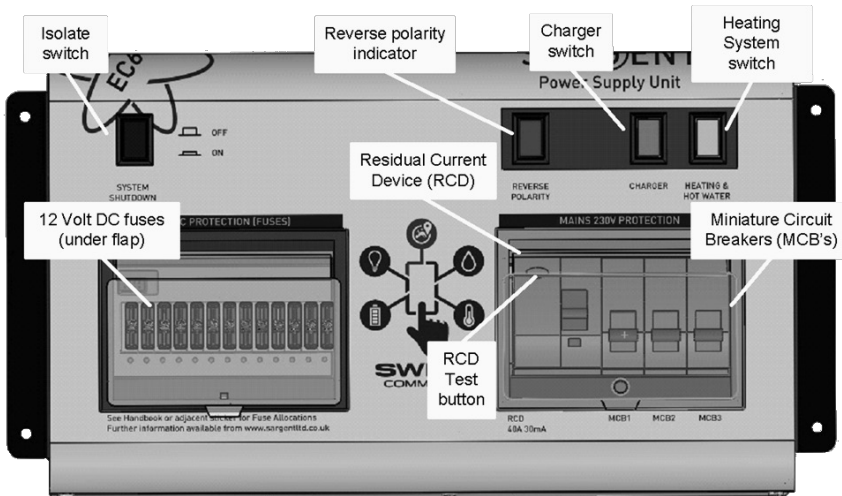

Activating the System

The system has a shutdown feature that can be used when the vehicle is in storage. This allows the leisure electronics to be turned off when not required to avoid flattening of the leisure and / or vehicle battery.

When in the off state only the alarm and tracking system supplies are still active, all other supplies are turned off.

Before using the system, please ensure the system shutdown switch is in the on position (button in) the system is now active.

Connecting to the Mains 230V supply and Safety checks

For your safety it is IMPORTANT that you follow these connections instructions each time your Leisure Vehicle is connected to a mains supply. This section assumes that the system is complete and that a Leisure battery has been installed.

A) Ensure suitability of the Mains Supply.

Your Leisure Vehicle should only be connected to an approved supply that meets the requirements of BS7671 or relevant harmonised standards. In most cases the site warden will hold information regarding suitability of supply. If using a generator, you also need to comply with the requirements / instructions supplied with the generator. Please note that some electronic generators may not be compatible with your leisure system. Further generator operational information is contained on section 8.13.

B) Switch the PSU Battery Charger / Power Converter OFF.

Locate the green 'Charger' power switch on the PSU and ensure the switch is in the off position (button out) before connection to the mains supply.

C) Connect the Hook-up Lead.

Firstly, connect the supplied hook-up lead (orange cable with blue connectors) to the Leisure Vehicle and then connect to the mains supply.

D) Check Residual Current Device operation.

Locate the RCD within the PSU and ensure the RCD is switched on (lever in up position). Press the 'Test' button and confirm that the RCD turns off (lever in down position). Switch the RCD back to the on position (lever in up position). If the test button failed to operate the RCD see section 8.13.

E) Check Miniature Circuit Breakers.

Locate the MCB's within the PSU (adjacent to the RCD) and ensure they are all in the on (up) position. If any MCB's fail to 'latch' in the on position see section 8.13.

F) Turn the PSU ON.

Locate the black 'Shutdown' button and ensure it is in the on position (press button in). Locate the green 'Charger' switch on the PSU and turn to the on position (press button in). The charger switch will illuminate when turned on.

G) Check correct Polarity.

Locate the 'Reverse polarity' indicator on the PSU and ensure that the indicator is NOT illuminated. If the indicator is illuminated see section 8.13.

H) Check operation of equipment.

It is now safe to operate the 12V and 230V equipment.

Operation while driving

The power control system is designed to shutdown parts of the system while the engine is running. This is to meet Electro Magnetic Compatibility (EMC) regulations and to ensure the safe operation of the motorhome. With the engine running the screen will show a warning 'ENGINE RUNNING'.

Please ensure the system shutdown switch on the PSU is in the on (button in) position before driving. This will ensure the electronic system is active and will therefore be able to control the charging process, supply the refrigerator and monitor other system circuits.





If / when fitted, designated 12V sockets, enroute reading lights and enroute heating will remain operational while the engine is running.

8.11 Control Panel - Layout

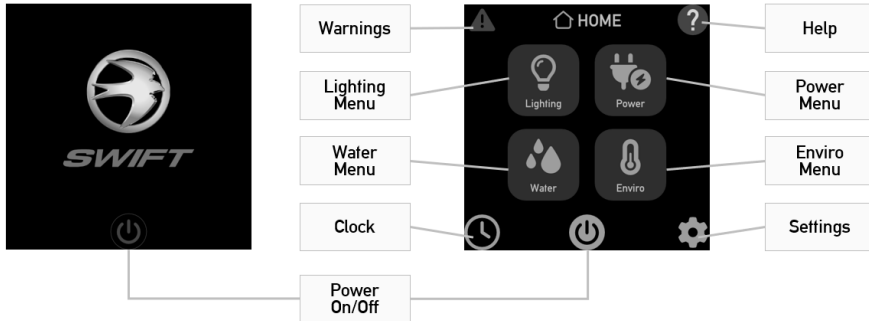
Your control panel will have an appearance as below, but depending on your vehicle specification the control panel features will vary. Not all features are present in all vehicles.

EC940 Control Panel



	<p>Power On/Off Button - After activating the PSU by pressing the System Shutdown Button the display will beep twice and show the Swift start-up logo. To activate power to all circuits, press the power on/off button, the panel will beep once. To turn the power off and enter standby mode, press the power button again. Note:- If the display has been inactive for some time, the backlight will be switched off to save power. Simply tap the screen to restore normal brightness.</p>
 <p>Lighting</p>	<p>Lighting Menu - Press the lighting button to show the lighting control screen. Here you can turn on / off or adjust the dimmable lighting levels.</p>
 <p>Power</p>	<p>Power Menu - Press the power button to show the power information and control screen. Here you can view leisure/vehicle battery condition, and check battery charger and solar charger currents.</p>
 <p>Water</p>	<p>Water Menu - For vehicles fitted with inboard water tanks, press the water button to show the water tank information and control screen. Here you can view tank levels and control related features.</p>



Pump

Pump Button - For vehicles not fitted with inboard water tanks, press the pump button to turn the water pump on. Press the button again to turn the pump off. The button border will illuminate when the pump is on.



Enviro

Environmental Menu - Press the enviro button to show the internal and external temperature in degrees Celsius. Also shown is the internal relative humidity.



Warnings Button - The system incorporates a number of warnings, for example if the battery becomes low. When a warning is active a warning box will appear along with an audible beeping sound. Until the warning has been fully cleared, the warning indicator will remain Red. Press the indicator to view any active warnings.



Help Button - Press the help button to display the context sensitive help screens. These will provide more detail about how to use the currently selected screen.



Clock Button - Press the clock button to display the current time in 24hr format. This screen also provides status tiles for the leisure battery, fresh water tank, 230V mains and solar panel charging, where fitted.



Settings Button - Press the settings button to show the general settings screen. Here you can set the date & time, screen brightness and screen on-time, key beeps etc. There are also buttons on this screen to pair or delete Bluetooth devices. Press the home button to return to the main screen.



Advance button - Pressing this button will advance to the next main section, for example to move between Lighting, Power, Water and Enviro screens



Next Button - Pressing this button moves to the next screen within a section, for example to move between Leisure and Vehicle battery screens



Home Button - Pressing this button will go back to the Main Menu screen

Clock / Status Screen

Clock screen - This screen not only displays the current time and date but also provides status tiles for the main services in the vehicle such as leisure battery and fresh water tank (if fitted)

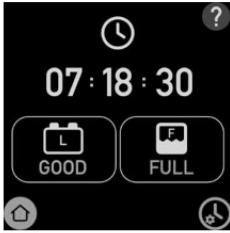

	Leisure Battery – The charge status is shown GOOD – No charge required FAIR – Charge recommended POOR – Charge immediately CHARGING – Charger is switched on DISCONNECTED – No battery detected
	Fresh Water (if fitted) - The water tank level is shown FULL – 100% GOOD – 50% to 99% LOW – 25% to 49% EMPTY – less than 25%
	Clock Setup – Press this button to access the clock setup screen

Clock setup – Use this screen to set the current time and date

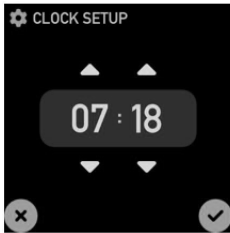

	Set Time – Use the up / down arrows to set the required time
	Confirm settings – Use the tick to confirm the settings or cross to cancel the settings

Note: the clock has a power backup, which can retain the clock settings for a number of weeks. If the vehicle has been stored for longer than this with no 12 volt power, the clock may need to be reset.

Environmental Readings

The EC940 system uses two sensors to measure internal temperature/humidity and external temperature. The combined internal temperature and humidity sensor is furniture mounted within the motorhome, and the external sensor is mounted below the motorhome floor. The figures displayed are for information only, and it is hoped the information will be useful.

For vehicles fitted with Alde or Truma heating systems, this sensor is not used to control the heating temperature, as it is measured separately above the door by the Alde or Truma room sensor. The readings on the heating system may vary relative to the one shown on the EC940 control panel.

For vehicles fitted with a Whale heating system, the sensor may be used to control the heating temperature as the system may not have its own sensor.



	Internal – The internal temperature and humidity is shown along with a bar graph
	External – The external temperature is shown along with a bar graph

Water System Operation

The EC940 control panel pump button operates the internal water pump drawing water from an on-board tank if fitted, or an external container when no tank is fitted.

The water tanks (fresh & waste) incorporate a level warning feature to warn the user when the fresh water level drops below 25% or when the waste water level reaches 100%. These warnings can be enabled / disabled from the User Settings screen.

If the water pump power is turned on and the fresh water level drops to below 25% a warning beep will be heard and a message will be displayed on the control panel. To cancel the warning, press the bell icon.

If the water pump power is turned on and the waste water level rises to full (100%) a warning beep will be heard and a message will be displayed on the control panel. To cancel the warning, press the bell icon.

These warnings will not be repeated unless the water pump power switch is turned off and on again. This is to ensure the warning does not become a nuisance.

Fresh Water Tank screen - Here you can view the on-board fresh water tank level and control water tank related features.

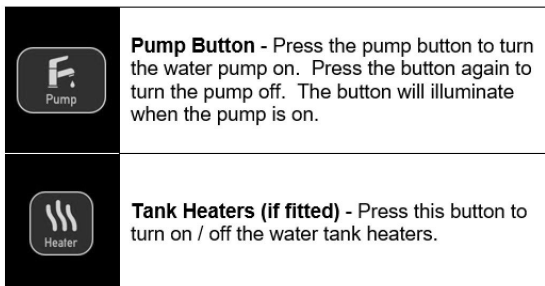
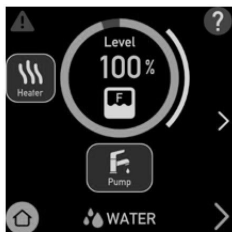

Waste Water Tank screen - Here you can view the on-board waste water tank level and control water tank related features.

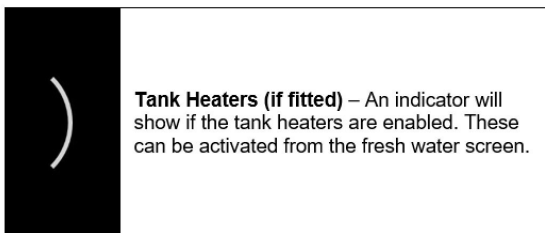
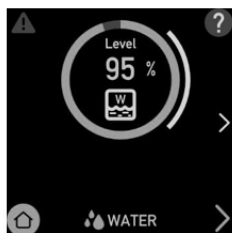

Lighting & Dimming Operation

The system contains one dimming channel for groups of lights which can be dimmed, turned on and turned off by this screen and can also be turned on and off by furniture mounted switches.

The entry light can be controlled from the local switch adjacent to the entry door (if fitted) or the control panel entry light button. Each item can toggle the light on or off.

The awning light can be controlled from a number of sources, the control panel awning light button or the lock and unlock system (dependant on system setting being set to do so). Each item can toggle the light on or off.

Lighting screen - Here you can turn on / off or adjust the dimmable lighting levels.



	<p>Dimmer Button - Press this button to turn the dimmable lighting on or off.</p>
	<p>Dimming Level - To change the dimming level, either press the (+) or (-) buttons or drag the slider to the required level. The dimming level is shown as a percentage.</p>

Power Management

The status of the leisure and vehicle batteries can be viewed on the control panel display by selecting the Power menu. Pressing the 'next screen' button will switch between leisure battery, vehicle battery and solar power.

The EC403PSU, EC454PSU or EC456PSU PSUs incorporate a built-in solar charge management feature, which will monitor the input from a separate solar panel and regulator if fitted. The current produced from the solar regulator is displayed along with an indication of which battery is being charged. Depending on the charge state of the batteries, the solar power will be directed to the required battery and continuously monitored to ensure optimum operation.

Battery Power screen (12V) - Here you can view battery levels, view charger and solar current and press the more button (right arrow) to view 230V current.



	<p>Selected Battery - Use the selected battery button to choose which battery you wish to use or charge with the 230V charger.</p>
	<p>Battery Condition - the battery condition will be shown on the dial and also described as below, GOOD - No charge required FAIR - Charge recommended POOR - Charge immediately CHARGING - Charger is switched on DISCONNECTED - No battery detected</p>
	<p>Battery Voltage - The voltage value will be shown together with a <u>bargraph</u>.</p>
	<p>Battery Current - The battery current will be shown together with a <u>bargraph</u>.</p>
	<p>Current Direction - A symbol with show if current is going into or out of the battery or if the battery is inactive.</p>

Solar Power screen (12V) - Here you can view the charging current being provided from solar panel (if fitted)

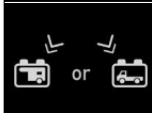

	Charging Current – The charging current available from the solar panel will be shown.
	Selected Battery – The battery currently being charged by the solar panel is shown, this can be the leisure or vehicle battery.

Solar Power screen (12V) - Here you can view the charging current being provided from solar panel (if fitted)

Smart Charging

The EC454PSU & EC456PSU incorporates a smart charge feature, which monitors both leisure and vehicle batteries and automatically adjusts and directs the charger power (and solar power if a solar panel is installed) to maintain the leisure and vehicle batteries at an optimal level.

Note: If the vehicle battery is isolated using the Fiat ignition key isolator or similar, some smart charging functionality will be lost, and the available charge will be directed to the leisure battery.

Electric Step Operation

On vehicles fitted with an electric step, this is operated by a button near the entry door. Press and release the button to move the step in or out. One press of the button will move the step out; a further press will move the step in again.

If the engine is started the step will move in automatically, after a short warning buzzer. If this operation fails due to an obstacle a buzzer will sound continuously to warn that the step is still out, and therefore requires your attention.

8.12 System Warnings

The system incorporates a number of warnings that are active at specific times. These are summarised in the table below and also covered by relevant sections of this manual.

Warning screens - When a warning is active a warning screen will appear on the control panel screen containing a description of the warning along with an audible beeping sound.

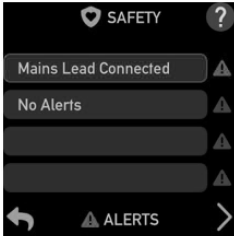



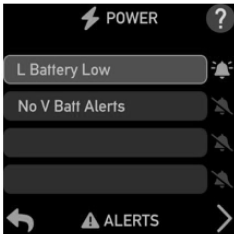

Example safety warnings



Example Power warnings

	<p>Active Warning – If a warning becomes active, it will be highlighted (Orange for power/water alerts and Red for safety alerts)</p>
	<p>Muting a warning – To mute the warning sound, press the bell icon next to the alert. The icon will then become Grey and the sounder will stop. Note that safety warnings can only be muted by correcting the cause e.g., removing mains lead whilst engine is running</p>
	<p>Clearing a warning – The warning will remain highlighted until it is fully cleared, for example by re-filling the water tank or re-charging the battery</p>

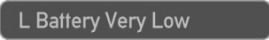
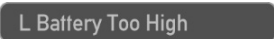
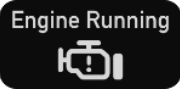
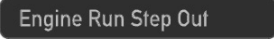
Warning	When	Type
<p>Fresh water level low</p> 	<p>With pump turned on and fresh water level low (less than 25% full)</p> <p>Only available when an on-board tank is fitted</p>	<p>Message on screen and 60 second audible beep</p>
<p>Waste water level full</p> 	<p>With pump turned on and waste water level full.</p> <p>Only available when an on-board tank is fitted</p>	<p>Message on screen and 60 second audible beep</p>
<p>Leisure battery voltage low</p> 	<p>With control panel power on and leisure battery selected (as active battery) and the voltage level falls below 10V</p>	<p>Message on screen and 60 second audible beep.</p>

Warning	When	Type
Leisure battery voltage very low 	With control panel power on and leisure battery selected (as active battery) and the voltage level is below 9V	Message on screen and 60 second audible beep. If no action taken after 30 seconds, then the system will switch the power off to prevent severe discharge of the battery
<p>Note: This is an emergency cut off level to protect the battery from severe damage. You should not rely on this cut off level during normal operation, but manage your power consumption to a discharge level of 11.5V or above.</p> <p>This cut off only applies to power drawn from the battery by the leisure equipment that is controlled by the control panel power switch; it will not protect the battery from discharge by permanently connected equipment.</p>		
Leisure battery voltage high 	With control panel power on or off and leisure battery is selected (as active battery) and the voltage level rises above 15V	Message on screen and repeated beeps from the control panel. The power is automatically turned off. The beeping will not stop until the fault is cleared.
Vehicle battery warnings	If the vehicle battery is selected instead of the leisure battery, then similar warnings to those described above are applied to the vehicle battery. The vehicle battery low warning level is 10.9V	
Engine running 	When the engine is started the system power will be turned off	Message on screen stating 'engine running'.
Step extended 	Step extended and engine started Step jammed or obstructed	Message on screen and warning buzzer
Mains lead (hook-up cable) still connected / plugged in 	When the engine is started and the mains cable is still plugged in and the charger is switched on	Message on screen and repeated beeps from the control panel. The beeping will not stop until the hook-up lead is removed.

User Settings & Bluetooth Pairing

The EC940 control panel has a number of user settings, which can be accessed by pressing the User Settings button. This screen also displays the software version number of the PSU, Control Panel and the communicator / tracking unit details, if a Sargent EC660 Communication Unit is fitted.

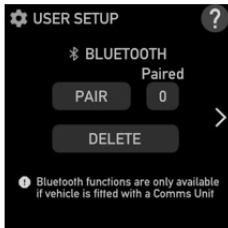

The Bluetooth pairing process is covered below, should you have an EC660 Communication Unit fitted. Further help with Bluetooth pairing is available in the form of a help video which can be viewed on the Sargent website in the Support Information section.

User Settings screen - Here you can set the key beeps, screen brightness, screen on time etc.

	<p>Settings – Use the arrows to select the setting to adjust, then adjust the setting below as required. Once all required settings have been made, press <i>Tick Button</i> to confirm. (see table below for more detail)</p>
	<p>Reset – Press the <i>Reset Button</i> then press <i>Tick Button</i> to reset setting to factory defaults</p>
	<p>Press the <i>Next Button</i> to enter the Bluetooth screen, then press the <i>Pair Button</i> to start pairing with your compatible Bluetooth device. The button will change to show PAIRING when pairing is active. You can now pair your device to the communications unit, following the devices instructions. Once paired correctly the <i>Paired</i> box will increment by one e.g., from '0' to '1' Pairing remains active for 1 minute and is then turned off automatically.</p>
	<p>Press the <i>Delete Button</i> to delete any Bluetooth pairings from the system. The button will change to show DELETING until the pairings have been deleted</p>

Section	Possible Settings	Description
Key Beep	On / Off	Turn the key beep sound on or off
LCD Brightness	10% to 100%	Adjust screen brightness
Backlight Time	30 seconds to 1 hour + Always On	Adjust time before screen backlight goes off
Water Alarms	On / Off	Turn the water alarms beep sound on or off
Lighting Mode	None / Lights / Lights & Dimmer	Sets lighting behaviour when control panel is switched on, None – Not used Lights – Normal lights come on. Dimmable lights are off. Lights & Dimmer – Normal lights come on. Dimmable lights come on at the last used dim level setting

8.13 System Technical Information

The following section provides further technical information relating to the electrical system. You can also access the supporting technical manual from www.sargentltd.co.uk

Residual Current Device & Miniature Circuit Breakers

The Residual Current Device (RCD) is basically provided to protect the user from lethal electric shock. The RCD will turn off (trip) if the current flowing in the live conductor does not fully return down the neutral conductor, i.e., some current is passing through a person down to earth or through a faulty appliance.

To ensure the RCD is working correctly, the test button should be operated each time the vehicle is connected to the mains supply (see section 2.3)

The Miniature Circuit Breakers (MCB's) operate in a similar way to traditional fuses and are provided to protect the wiring installation from overload or short circuit. If an overload occurs the MCB will switch off the supply. If this occurs you should investigate the cause of the fault before switching the MCB back on.

MCB	Rating	Output Wire Colour	Description
1	10 Amps	White	230V Sockets
2	16 Amps	White (Yellow for heater)	Extra 230V Sockets / Heating System
3	10 Amps	Black (Blue for Whale water heater)	Fridge / Charger / Auxiliary devices / Whale Water Heater

Generator Usage

Caution should be used before connecting a generator to your motorhome.

WARNING: Never start or stop the generator while electrical loads are connected and switched on. Start the engine, let it stabilise and then connect the electrical load. When stopping the generator, disconnect the electrical load and let engine stabilise before switching off.

Whilst some generators use electronic inverter technology, others use a more basic principle to generate the 230V supply. Preference should be to choose a generator which produces a consistent sinusoidal wave form with accurate voltage control.

The Reverse Polarity warning light on the PSU may illuminate when using a Generator. This is a normal side effect when using some types of generator. Instead of connecting the neutral conductor to earth, some generators centre-tap the earth connection making both neutral and live conductors 110V above earth. This 110V difference causes the neon polarity indicator to illuminate.

In most cases it is safe to use a generator, but please consult the generator handbook for further information.

Battery Charger

The system incorporates an intelligent three-stage battery charger.

During stage 1 the battery voltage is increased gradually while the current is limited to start the charging process and protect the battery. At stage 2 the voltage rises to 14.4V to deliver the bulk charge to the battery. When the battery is charged, the voltage is decreased at stage 3 to 13.6V to deliver a float charge to maintain

the battery in the fully charged state. The charger can be left switched on continuously as required.

The battery charger / power converter also provides power to the leisure equipment when the mains supply is connected. This module supplies DC to the leisure equipment up to a maximum of 25 Amps (300 Watts), therefore the available power is distributed between the leisure load and the battery, with the leisure load taking priority as per the following example:

Leisure load	Available power for battery charging
5A	20A
10A	15A
15A	10A
20A	5A

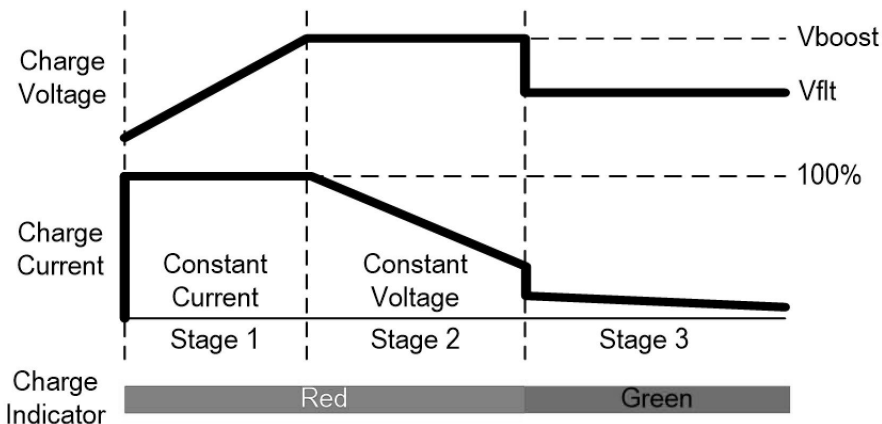

⚠ WARNING: Under heavy loads the Battery Charger case may become hot. ALWAYS ensure the ventilation slots have a clear flow of air. Do not place combustible materials against / adjacent to the charger.

Leisure Battery

A) Type / Selection

For optimum performance and safety, it is essential that only a proprietary brand LEISURE battery is used and it is suggested to select a battery from the NCC Verified Battery Scheme with a typical capacity of 75 to 180 Ah (Ampere / hours). Depending on the prospective use of the vehicle the correct type should be selected

(A, B or C). A normal car battery is NOT suitable. This battery should always be connected when the system is in use.

The PSU is configured to work with standard lead acid leisure batteries, and in most cases is also compatible with the latest range of Absorbed Glass Matt (AGM) batteries. The system is also suitable for Lithium batteries with built-in Battery Management Systems (BMS). Before fitting non-standard batteries please

check that the charging profile as described above is suitable for the type of battery by referring to the battery documentation or battery manufacturer.

Some vehicle installations can cater for two leisure batteries connected in parallel. In these cases, it is recommended that two identical batteries are used.

The battery feed is fitted with an inline fuse between the battery and the electrical harness, and is usually located immediately outside the battery compartment or within 500mm of the battery. The maximum rating of this fuse is 20A per battery. If a single battery is fitted this fuse could be up to 40A, however if two batteries are fitted each battery should be fused at a maximum of 20A.

B) Installation & Removal

Always disconnect the 230V mains supply and turn the PSU green charger switch to the off position (button out) before removing or installing the battery.

When connecting the battery, ensure that the correct polarity is observed (black is negative [-] and red is positive [+]) and that the terminals are securely fastened. Crocodile clips must not be used.

Note: If a tracking solution is fitted with an active Thatcham subscription, it is advised to inform the tracking call centre before removing the battery, to avoid an unnecessary security call.

WARNING: Explosive gases may be present at the battery. Take care to prevent flames and sparks in the vicinity of the battery and do not smoke.

C) Operation / Servicing

Under normal circumstances it should not be necessary to remove the battery other than for routine inspection of the terminals and "topping up" of the battery fluid where applicable. Please see instructions supplied with the battery.

Note: Do not over discharge the battery. One of the most common causes of battery failure is when the battery is discharged below the recommended level of approximately 10V. Discharging a battery below this figure can cause permanent damage to one or more of the cells within the battery.

To prevent over discharge, the power control system incorporates a battery protect circuit that warns the users and then disconnects the batteries when they fall below set values.

If a warning is active a beep will be emitted by the control panel and information will be shown on the screen. To mute the warning, press the bell icon. These warnings will not be repeated unless the power switch is turned off and on again. This is to ensure the warning does not become a nuisance.

Battery	Voltage cut off	Action after cut off	Notes
Vehicle	10.9V	Battery selection is changed from Vehicle battery to Leisure battery. If the leisure battery is below 9V then a further warning will occur (see below).	This cut off level is designed to protect the vehicle battery from over discharge. The 10.9V level ensures there is sufficient power in the battery to run the vehicle electronics and start the vehicle. This cut off only applies to power drawn from the battery by the leisure equipment; it will not protect the battery if you leave vehicle circuits switched on, such as the road lights.

Battery	Voltage cut off	Action after cut off	Notes
Leisure	9V	Power is turned off	<p>This is an emergency cut off level to protect the battery from severe damage. You should not rely on this cut off level during normal operation, but manage your power consumption to a discharge level of about 11.5V.</p> <p>This cut off only applies to power drawn from the battery by the leisure equipment that is controlled by the control panel power switch; it will not protect the battery from discharge by permanently connected equipment.</p>

12 Volt DC Fuses

⚠ WARNING: When replacing fuses always replace a fuse with the correct value. NEVER replace with a higher value / rating as this could damage the wiring harness. If a replacement fuse 'blows' do not keep replacing the fuse as you could damage the wiring harness. Please investigate the fault and contact your dealer.

The following table shows the fuse allocation for the 13 fuses fitted to the PSU. Please note that fuses are dependant on PSU versions, so not all fuses may be present.

Fuse	Rating	Fuse Colour	Description
1	25 Amps	White	Charger
2	7.5 Amps	Brown	Permanent 12V / Alarm / Fridge Electronics
3	10 Amps	Red	12V Sockets / TV Amplifier
4	10 Amps	Red	Extractor Fans
5	5 Amps	Tan	Appliances / Hob Ignition / Toilet / Whale Water Heater
6	10 Amps	Red	Water Pumps / Tank Heaters
7	10 Amps	Red	Lighting, Main Lights & Dim Channel 1
8	10 Amps	Red	Lighting, Entry Light & Dim Channel 2
9	10 Amps	Red	Alde Heating, Truma Heating, Whale Air Heater, Marker Lights, En-Route Sockets & Lights
10	10 Amps	Red	Auxiliary / Awning Light / Electric Step
11	10 Amps or 15 Amps or 20 Amps	Red Blue Yellow	Compressor Fridge Supply Under counter Fridge 12V Fridge freezer 12V
12	15 Amps	Blue	Towing 12V
13	15 Amps or 20 Amps	Blue Yellow	Under counter Fridge D+ Fridge freezer D+

① **Note:** Fuses (2-13) have a Red LED below them which provides indication that the fuse has blown. The charger fuse has a green LED which indicates that the charger is working. Fuses 11 and 13 are 10A for compressor fridges, 15A for under counter fridges and 20A for fridge freezers.

The following table shows details of the fuse(s) located at the Leisure battery.

Fuse	Rating	Fuse Colour	Description
Battery 1	40 Amps	Orange	Fuse remotely located near battery
Battery 2	40 Amps	Orange	Fuse remotely located near battery 2 (where fitted)

8.14 Common Fault Table

Fault	Possible Cause	Proposed Fix
No 230-volt output from PSU	Connecting lead between the site and Leisure Vehicle not connected	Check and connect lead as per 8.10 (Connecting to the mains 230v supply and safety checks C)
	RCD switched off	Reset RCD as per 8.10 (Connecting to the mains 230v supply and safety checks D)
	RCD not operating correctly	Check supply polarity; if the RCD continues to fail contact your Dealer as there is probably an equipment or wiring fault.
	MCB switched off	Reset MCB by switching OFF (down position) then back ON (up position), if the MCB continues to fail contact your Dealer as there is probably an equipment or wiring fault.
	No or deficient supply from site	Contact site Warden for assistance.
	Another fault	Contact your Dealer.
Reverse Polarity light is illuminated on PSU	Mains Supply reversed?	The reverse polarity light is designed to illuminate when the Live and Neutral supply has been reversed / crossed over. If the light illuminates there is a problem with the site supply or the cable connecting the supply to your vehicle. The light is designed to work on UK electrical supplies (where the neutral conductor is connected to earth at the sub station). If you are using your vehicle outside the UK this light may illuminate when no fault exists. In these cases, consult the site warden for advice.
	Generator being used	'The Reverse Polarity warning light is on when using my Generator'. This is a normal side effect when using some types of generator. Instead of connecting the neutral conductor to earth, some generators centre-tap the earth connection making both neutral and live conductors 110V above earth. This 110V difference causes the neon polarity indicator to illuminate. In most cases it is still safe to use the generator, but please consult the generator handbook for further information.

Fault	Possible Cause	Proposed Fix
Control Panel Problems	Control Panel has no display	<p>Check batteries and fuses, turn PSU isolate switch and charger switch on and ensure mains supply is connected.</p> <p>Check control panel connecting lead at PSU and behind Control Panel.</p> <p>Contact your Dealer.</p>
	12V Power turns off	<p>Battery protect feature has operated to protect the Vehicle battery and or the Leisure battery. See 8.13 (Leisure battery C)</p> <p>Over voltage protection has been activated, the control panel will display a warning. A number of things can cause this but the most common is the solar panel, it is worth checking the regulator is connected correctly and operating within the correct parameters.</p> <p>Engine has been started; all equipment has been disconnected to meet EMC requirements. See 8.10 (Operation while driving)</p>
	Control Panel locked / erratic function	<p>Observe control panel handling instructions.</p> <p>Control panel software may have crashed. Reboot control panel by turning off the PSU isolate switch. Wait 30 seconds then turn the switch back on. Check with your dealer that your system has the latest software installed, as an update may be available.</p>
No 12-volt output from PSU	No 230V supply	Check all above.
	Charger not switched on	Turn charger switch on, switch will illuminate.
	Battery not connected and / or charged	Install charged battery as per 8.13
	Power button on control panel not switched to on	Turn power on at control panel.
	Battery flat / Battery fuse blown	Recharge battery, check fuses, check charging voltage is present at battery.
	Fuse blown	Check all fuses are intact and the correct value fuse is installed as per fuse table.
	Equipment switched off / unplugged	Check equipment is switched on and connected to the 12V supply.
	Another fault	Contact your Dealer.
Pump not working	Fuse blown	Replace fuse with correct value as per fuse table.
	Pump turned off	Turn pump on by pressing the pump button at the control panel.
Lights not working	Fuse/s blown	Replace fuse with correct value as per fuse table.
	Lights turned off	Turn Lights on by pressing the lights button, use dimmer at the control panel.

Technical Support

If you require technical support on Sargent products then please visit the Support Customer Support site at <https://sargent.zohodesk.eu/portal/en/home> In the Knowledge Base you can view product documentation and search frequently asked questions and in the Ticket section you can raise a ticket to request help from the support team.

Updates

From time to time there may be updates to the system firmware; these updates will be done at service intervals by your dealership.

8.15 Technical Data & Approvals

Equipment – EC403PSU, EC454PSU, EC456PSU, EC940, EC660 & PX300

Outline Specification		
INPUT 230V	230 Volts / 0 to 16 Amps	+ / - 10%
OUTPUT 230V	RCD protected, 2 x MCB outputs of 10A & 1 x MCB output of 16A Separate switched channels for heating system and charger	
INPUT 12V	2 x 20A battery inputs via 2 x 4-way connectors	
SOLAR INPUT	1 X Dedicated solar panel input capable of supporting 10A of solar power input (typically 180 to 200W) via a 2-way connector	Check the solar panel rating plate to ensure the maximum current is <= 10A
OUTPUT 12V	25A total output via multiple switched channels protected by 13 fused outputs	
Integrated CHARGER	Input 220-240 Volts AC +/- 10%, Frequency 50 Hz +/- 6%, Current 3A max. DC Output 13.6 to 14.4 Volts nominal, Current 25 Amps max (300 Watts).	
Signal INPUT	4 x Fresh water level, 4 x Waste water level, 1 x Engine running, plus multiple vehicle connections, sensor inputs for temperature & humidity	Fresh water negative sensed Waste water negative sensed
Data IN / OUT	CANBUS Data communication and power to Control Panel via 6-way connector CI-Bus Data communication to CI-Bus enabled devices via RJ11/12 connector	
IP rating	IP31	
Operating temperature	Ambient 0 to 35° Celsius Charger case temperature with full load 65° C Max	Automatic shutdown and restart if overheated / overloaded

Dimensions		
EC403PSU, EC454PSU, or EC456PSU	Overall size (HxWxD) 180 x 305 x 135mm Clearances 75mm above, 50mm left & right	Weight 3.8 Kg
EC940 Control Panel	Overall size (HxWxD) 94 x 94 x 26mm Cut-out size (HxW) 86 x 86mm	Fixing via hidden spring clips Weight 135g
EC850 Sensor	Overall size (HxWxD) 20 x 35 x 38mm	Weight 10g

8.16 Approvals

System: BSEN 1648-1, BSEN1648-2 compliant, BS7671: 2018 compliant

Residual Current Device: RCD 40A 30mA trip to BS EN 61008

Miniature Circuit Breakers: MCB's type C 6000A breaking capacity to BSEN 60898

Electro Magnetic Compatibility (EMC) directive 2004/108/EC Certificate CE20071224-1

Integrated Charger: BS EN 60335-1/2.29, 2006/95EC, IEC61000-3.2/3:1995, 1.

Low Voltage Directive: 2006/95EC TUV-014900-A1, EN55022, Class B, EN55024/ Level 2

Declaration of Conformity

Equipment: Leisure Power Control System Model name: EC403PSU, EC454PSU, EC456PSU, EC940, EC660 & PX300

I hereby declare that the equipment named above has been designed to comply with the relevant sections of the above referenced approvals. The unit complies with all essential requirements of the Directives.

Signed	Name	Position	Manufacturer
	IL Sargent	Technical Director	Sargent Electrical Services Ltd Unit 35, Tokenspire Business Park Woodmansey, Beverley East Yorkshire, United Kingdom
Date:			

Whilst every effort has been made to ensure the accuracy and completeness of this document, no guarantee is given against errors or omissions. This document may be updated / improved over time therefore please check with your dealer / supplier for update information or visit

www.sargentltd.co.uk

8.17 Swift Command Power Control System (Kon-Tiki)

This section of the handbook will guide you through the operation of the electrical system. All details are correct at the time of going to press. Please also see the online version which will include any later updates or amendments.

Further technical details are contained in section 3 or in the supporting technical manual available from www.sargentltd.co.uk

For the safe operation of all electrical equipment within your Leisure Vehicle it is important that you read and fully understand these instructions. If you are unsure of any point, please contact your dealer / distributor for advice before use.

The system has a number of key components that you will need to be familiar with before attempting to use the system, these are:

- The EC601, EC602, EC652 or EC653 Power Supply Unit (PSU) - a combined mains consumer unit and 12V controller usually located in a storage area (lower bed box, wardrobe or similar).
- The EC970 Control Panel (CP) - a remotely located user control panel used to turn circuits on and off and to display battery, water tank and other system information. This panel uses a graphical touchscreen with straightforward controls and reliable data communication to the PSU.
- The PX300 Intelligent Battery charger 300W.

8.18 Using the System

Power Supply Unit - Component Layout.

The PSU is usually located in the front offside bed box area.

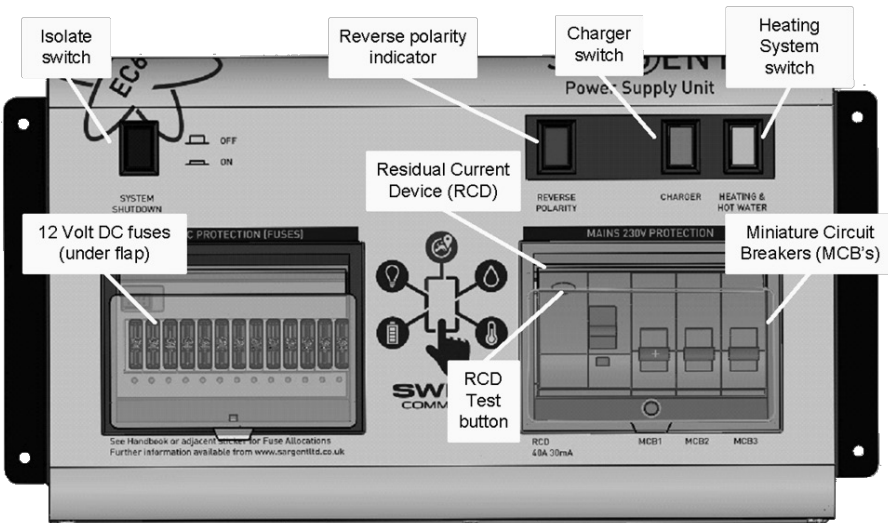

Fig 1

Activating the System

The system has a shutdown feature that can be used when the vehicle is in storage. This allows the leisure electronics to be turned off when not required to avoid flattening of the leisure and / or vehicle battery. When in the off state only the alarm and tracking system supplies are still active, all other supplies are turned off.

Before using the system, please ensure the system shutdown switch is in the on position (button in) the system is now active.

ⓘ Note: If you plan to use the Swift Command remote features, the system needs to be active. If you wish to use remote features during storage, for example to check the battery levels, it is recommended a solar panel is fitted and the vehicle is stored outside, to avoid flattening of the leisure battery.

Connecting to the Mains 230V supply and Safety checks

For your safety it is IMPORTANT that you follow these connections instructions each time your Leisure Vehicle is connected to a mains supply. This section assumes that the system is complete and that a Leisure battery has been installed (see 3.4).

A) Ensure suitability of the Mains Supply.

Your Leisure Vehicle should only be connected to an approved supply that meets the requirements of BS7671 or relevant harmonised standards. In most cases the site warden will hold information regarding suitability of supply. If using a generator, you also need to comply with the requirements / instructions supplied with the generator. Please note that some electronic generators may not be compatible with your leisure system. Further generator operational information is contained in section 3.2.

B) Switch the PSU Battery Charger / Power Converter OFF.

Locate the green 'Charger' power switch on the PSU and ensure the switch is in the off position (button out) before connection to the mains supply.

C) Connect the Hook-up Lead.

Firstly, connect the supplied hook-up lead (orange cable with blue connectors) to the Leisure Vehicle and then connect to the mains supply.

D) Check Residual Current Device operation.

Locate the RCD within the PSU and ensure the RCD is switched on (lever in up position). Press the 'Test' button and confirm that the RCD turns off (lever in down position). Switch the RCD back to the on position (lever in up position). If the test button failed to operate the RCD see section 3.1.

E) Check Miniature Circuit Breakers

Locate the MCB's within the PSU (adjacent to the RCD) and ensure they are all in the on (up) position. If any MCB's fail to 'latch' in the on position see section 3.1.

F) Turn the PSU ON.

Locate the black 'Shutdown' button and ensure it is in the on position (press button in). Locate the green 'Charger' switch on the PSU and turn to the on position (press button in). The charger switch will illuminate when turned on.

G) Check correct Polarity.

Locate the 'Reverse polarity' indicator on the PSU and ensure that the indicator is NOT illuminated. If the indicator is illuminated see section 3.2.

H) Check operation of equipment.

It is now safe to operate the 12V and 230V equipment.

Operation while driving

The power control system is designed to shutdown parts of the system while the engine is running. This is to meet Electro Magnetic Compatibility (EMC) regulations and to ensure the safe operation of the motorhome. With the engine running the screen will show a warning 'ENGINE RUNNING'.

Please ensure the system shutdown switch on the PSU is in the on (button in) position before driving (see 2.2). This will ensure the electronic system is active and will therefore be able to control the charging process, supply the refrigerator and monitor other system circuits.

If / when fitted, designated 12V sockets, enroute reading lights and enroute heating will remain operational while the engine is running.





Component Layout (see image below)

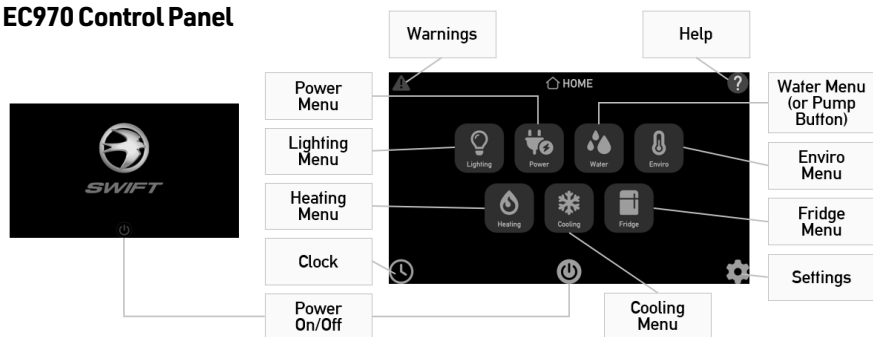







Your control panel will have an appearance as below, but depending on your vehicle specification the control panel features will vary. Not all features are present in all vehicles.





EC970 Control Panel



E970 Control Panel - Key Features

	<p>Power On/Off Button - After activating the PSU by pressing the System Shutdown Button the display will beep twice and show the Swift start-up logo. To activate power to all circuits, press the power on/off button, the panel will beep once. To turn the power off and enter standby mode, press the power button again. Note:- If the display has been inactive for some time, the backlight will be switched off to save power. Simply tap the screen to restore normal brightness.</p>
 <p>Lighting</p>	<p>Lighting Menu - Press the lighting button to show the lighting control screen. Here you can turn on / off or adjust the dimmable lighting levels.</p>
 <p>Power</p>	<p>Power Menu - Press the power button to show the power information and control screen. Here you can view leisure/vehicle battery condition, and check battery charger and solar charger currents.</p>
 <p>Water</p>	<p>Water Menu - For vehicles fitted with inboard water tanks, press the water button to show the water tank information and control screen. Here you can view tank levels and control related features.</p>





 <p>Pump</p>	<p>Pump Button - For vehicles not fitted with inboard water tanks, press the pump button to turn the water pump on. Press the button again to turn the pump off. The button border will illuminate when the pump is on.</p>
 <p>Enviro</p>	<p>Environmental Menu - Press the enviro button to show the internal and external temperature in degrees Celsius. Also shown is the internal relative humidity.</p>
 <p>Heating</p>	<p>Heating Menu - Press the heating button to show the heating control screen. Here you can control the heating system, select energy and temperature and set related timers.</p>
 <p>Cooling</p>	<p>Cooling Menu - Press the cooling button to show the aircon control screen. Here you can select the operating mode, set the target temperature and adjust the fan speed. Press the home button to return to the main screen.</p> <p>Note: this button will only be visible if a CI-Bus equipped air conditioner is installed, connected and enabled within the system.</p>
 <p>Fridge</p>	<p>Fridge Menu - Press the fridge button to show the fridge control screen. Here you can select the operating mode, set the cooling setting and view the temperature status. Press the home button to return to the main screen.</p> <p>Note: This button will only be visible if a CI-Bus equipped fridge is installed, connected and enabled within the system</p>
	<p>Warnings Button - The system incorporates a number of warnings, for example if the battery becomes low. When a warning is active a warning box will appear along with an audible beeping sound. Until the warning has been fully cleared, the warning indicator will remain Red. Press the indicator to view any active warnings.</p>
	<p>Help Button - Press the help button to display the context sensitive help screens. These will provide more detail about how to use the currently selected screen.</p>
	<p>Clock Button - Press the clock button to display the current time in 24hr format. This screen also provides status tiles for the leisure battery, fresh water tank, 230V mains and solar panel charging, where fitted.</p>

	Settings Button - Press the settings button to show the general settings screen. Here you can set the date & time, screen brightness and screen on-time, key beeps etc. There are also buttons on this screen to pair or delete Bluetooth devices. Press the home button to return to the main screen.
	Advance button - Pressing this button will advance to the next main section, for example to move between Lighting, Power, Water and Enviro screens
	Next Button - Pressing this button moves to the next screen within a section, for example to move between Leisure and Vehicle battery screens
	Home Button - Pressing this button will go back to the Main Menu screen

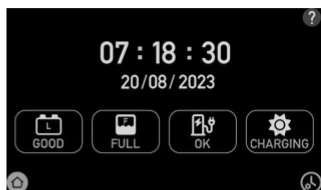
Clock / Status Screen

Clock screen - This screen not only displays the current time and date but also provides status tiles for the main services in the vehicle such as leisure battery, fresh water tank, 230V mains and solar charging.



	Leisure Battery – The charge status is shown GOOD – No charge required FAIR – Charge recommended POOR – Charge immediately CHARGING – Charger is switched on DISCONNECTED – No battery detected
	Fresh Water (if fitted) - The water tank level is shown FULL – 100% GOOD – 50% to 99% LOW – 25% to 49% EMPTY – less than 25%
	230V Mains – The mains supply status is shown OK – Mains current normal HIGH – Mains current over 75% capacity LIMITING – Current limiting activated INACTIVE – Mains power off
	Solar Charging (if fitted) – The solar panel charging status is shown CHARGING – Battery charging from solar INACTIVE – Not charging or panel not fitted
	Clock Setup – Press this button to access the clock setup screen

Clock / Status Screen

Clock setup – Use this screen to set the current time and date



	Set Time/Date – Use the up / down arrows to set the required time and date
	Confirm settings – Use the tick to confirm the settings or cross to cancel the settings

Note: The clock has a power backup, which can retain the clock settings for a number of weeks. If the vehicle has been stored for longer than this with no 12-volt power, the clock may need to be reset.

Environmental Readings

The EC970 system uses two sensors to measure internal temperature/humidity and external temperature. The combined internal temperature and humidity sensor is furniture mounted within the motorhome, and the external sensor is mounted below the motorhome floor. The figures displayed are for information only, and it is hoped the information will be useful, for example when checking temperatures remotely during cold weather.

For vehicles fitted with Alde or Truma heating systems, this sensor is not used to control the heating temperature as it is measured above the door by the Alde or Truma room sensor. The readings on the heating system may vary relative to the one shown on the EC970 control panel.

For vehicles fitted with a Whale heating system, the sensor may be used to control the heating temperature as the system may not have its own sensor.



	Internal – The internal temperature and humidity is shown along with a <u>bargraph</u>
	External – The external temperature is shown along with a <u>bargraph</u>

Water System Operation

The EC970 control panel pump button operates the internal water pump drawing water from an on-board tank if fitted, or an external container when no tank is fitted.

The water tanks (fresh & waste) incorporate a level warning feature to warn the user when the fresh water level drops below 25% or when the waste water level reaches 100%. These warnings can be enabled / disabled from the User Settings screen



If the water pump power is turned on and the fresh water level drops to below 25% a warning beep will be heard and a message will be displayed on the control panel. To cancel the warning, press the bell icon.

If the water pump power is turned on and the waste water level rises to full (100%) a warning beep will be heard and a message will be displayed on the control panel. To cancel the warning, press the bell icon.

These warnings will not be repeated unless the water pump power switch is turned off and on again. This is to ensure the warning does not become a nuisance.

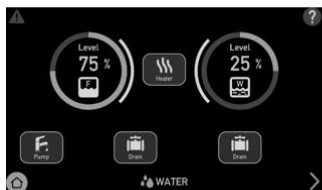
Fresh/Waste Water Tank screen - Here you can view the on-board fresh and waste water tank levels and control water tank related features.



	Pump Button - Press this button to turn the water pump on. Press the button again to turn the pump off. The button will illuminate when the pump is on.
	Drain Button (if fitted) - Press this button to open the drain valve, which will empty the fresh or waste water tank.
	Tank Heaters (if fitted) - Press this button to turn on / off the water tank heaters.

① **Note:** Tank valves are normally closed and will automatically close if the power is switched off or if they have been open for more than 10 minutes.

The entry light can be controlled from the local switch adjacent to the entry door (if fitted) or the control panel entry light button. Each item can toggle the light on or off.



Lighting & Dimming Operation

The system contains up to two dimming channels for groups of lights which can be dimmed, turned on and turned off by this screen and can also be turned on and off by furniture mounted switches.

The awning light can be controlled from a number of sources, the control panel awning light button or the lock and unlock system (dependant on system setting being set to do so). Each item can toggle the light on or off.

Lighting screen - Here you can turn on / off or adjust the dimmable lighting levels.



	Dimmer Button - Press the Dimmer1 or Dimmer2 button to turn the dimmable lighting on or off.
	Dimming Level - To change the dimming level, either press the (+) or (-) buttons or drag the slider to the required level. The dimming level is shown as a percentage.

Power Management

The status of the leisure and vehicle batteries can be viewed on the control panel display by selecting the Power menu. Pressing the Next Button will switch between 12V battery power and 230V mains power

The EC601/EC602/EC652/EC653 PSU incorporates a built-in solar charge management feature, which will monitor the input from a separate solar panel and regulator

if fitted. The current produced from the solar regulator is displayed along with an indication of which battery is being charged. Depending on the charge state of the batteries, the solar power will be directed to the required battery and continuously monitored to ensure optimum operation.

Power screen (12V) - Here you can view battery levels, view charger and solar current and press the more button (right arrow) to view 230V current.

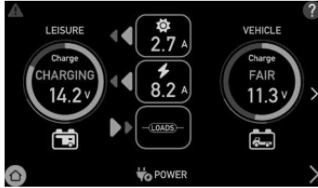

	<p>Selected Battery - Use the select battery button to choose which battery you wish to use or charge with the 230V charger.</p>
	<p>Battery Condition – the battery voltage will be displayed and the battery condition described as below, GOOD – No charge required FAIR – Charge recommended POOR – Charge immediately CHARGING – Charger is switched on DISCONNECTED – No battery detected</p>
	<p>Mains Charger Current – If the mains charger is providing charge, the current will be shown along with an arrow indicating which battery is being charged</p>
	<p>Solar Charger Current – If the solar panel is providing charge, the current will be shown along with an arrow indicating which battery is being charged</p>
	<p>Appliance Loads – An arrow will show when the selected battery is supplying power to the loads. If the mains charger is switched off, the load current will also be shown.</p>

Smart Charging

The EC652/EC653 PSU incorporates a smart charge feature, which monitors both leisure and vehicle batteries and automatically adjusts and directs the charger power (and solar power if a solar panel is installed) to maintain the leisure and vehicle batteries at an optimal level.

Note: If the vehicle battery is isolated using the Fiat ignition key isolator or similar, some smart charging functionality will be lost, and the available charge will be directed to the leisure battery.

AC Current Limiter Operation

The power control system features a 230V current monitoring system which allows the mains hook up current to be displayed on the control panel. The resolution of this reading is 0.5A. A current limit can be set based on the

available site hook-up supply, to avoid tripping of the site post. If the set limit is reached, it will switch off the electric elements in the heating system (and air-conditioning if fitted and enabled), until such time as the current drops and the elements will be switched back on. An example of this is if a kettle was to be operated whilst the heating was on and the current limit was reached, then the heater electric element would be temporarily switched off, when the kettle had boiled then the heater element would be switched back on automatically.

This feature is particularly useful when abroad on a low current supply.

Setting the value to OFF will disable this feature.

Power screen (230V) - Here you can view the 230V current and set the 230V current limiter.

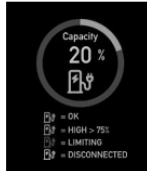
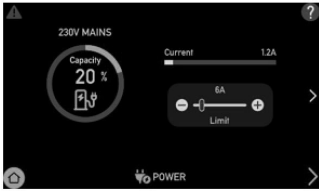

AC Capacity - A dial shows the percentage of available AC current being used. An indicator also shows the limit status
Green=OK, Orange >75%, Red=Limiting
Note: If the limit setting is OFF, the capacity will be based on the maximum site supply of 16Amps being available.

Current 1.2A

AC Current - The bar graph shows the 230V AC current being used by the vehicle (from the site hook-up)



Set Limit - To set a limit, either press the (+) or (-) buttons or drag the slider until the required limit level is reached.

Note: For this feature to work correctly the Heating mode must be set to Timer so that the system can control the heating appliance.

Heating Controls

There are a number of CI-Bus enabled heating systems that can be controlled by the power control system. If the heating systems are CI Bus enabled, the actual controls available will vary depending on which heating system components are fitted. The system will be

preconfigured by the manufacturer or supplying dealer. The related control panel screens are shown below.

Heating screen - Here you can control the heating system, such as setting target temperature, selecting the energy source and by pressing the Next Button set the related timers.

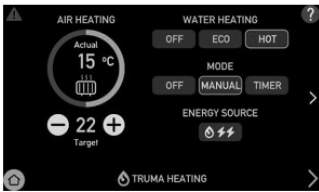

Truma example shown

Target 22

Target Temperature - To set the required temperature for Air Heating, press the (+) and (-) buttons

Actual 15 °C

Actual Temperature - The current temperature is shown along with a dial

WATER HEATING
OFF ECO HOT

Water Heating - The water heating can be switched on/off and the required temperature mode set. Controls will vary depending on heater model (see below)

MODE
OFF MANUAL TIMER

Heating Mode - The heating mode can be selected between Manual (use manufacturer controls) or Timer (use EC970 controls)

ENERGY SOURCE
flame icon

Energy Source - The source of energy for heating can be selected from electric, gas or a combination of both. Controls will vary depending on heater model (see below)

Note: You can also override the room temperature by making a change using the appliance control panel (Alde & Truma only). If you make a change the override will automatically activate. The override temperature will continue until the next timer event time.

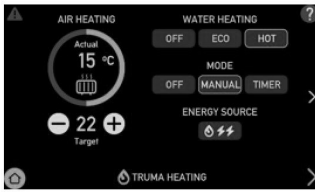

Truma Heating Option

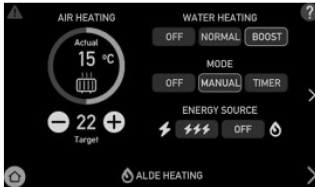

Alde Heating Option

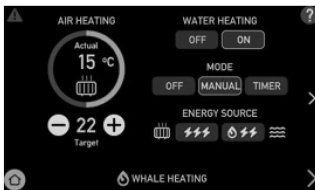
Whale Heating Option
(if appliances are CI Bus enabled)

	<p>Water heating – Select the required mode for water heating OFF - Turn water heating off ECO - Heat water to 40°C HOT - Heat water to 60°C</p>
	<p>Energy Source – Press the button to cycle through the available energy choices for heating</p>
	<p>Water heating – Select the required mode for water heating OFF - Turn water heating off NORMAL - Heat water to 50°C BOOST - Heat water to 65°C</p>
	<p>Energy Source – Press the buttons to cycle through the available energy choices for heating and water</p>
	<p>Water heating – Select the required mode for water heating OFF - Turn water heating off ON - Turn water heating on</p>
	<p>Energy Source (air heating) – Press the button to cycle through the available energy choices for air heating</p>
	<p>Energy Source (water heating) – Press the button to cycle through the available energy choices for water heating</p>

① **Note:** Changes made on the EC970 control panel may not be accepted on the heating controller immediately if the controller has been recently used and still has its backlight on. Please try to use one controller at a time.

Heating timer screen - On the heating screen press the more button (right arrow) to set or view the daily heating timers.

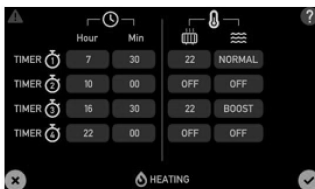

	<p>Timer - Press on the hour or minute value to change the setting. Timers should be set in order during the day (Timer 1 the earliest and Timer 4 the latest) and use the 24-hour clock.</p>
	<p>Air Heating Setting - Press the temperature values to change the setting. Each press will increment the value from Off, then 5 degrees through to 30 degrees Celsius.</p>
	<p>Water Heating Setting - Press the water values to change the setting. Each press will step through the available setting, which vary by appliance manufacturer as shown below, Truma - OFF, ECO or BOOST Alde - OFF, NORMAL or BOOST Whale - OFF or ON</p>

① **Note:** To use these timer settings the Heating mode must be set to Timer so that the system can control the heating appliance.

Refrigerator Controls

This section is only relevant when a CI-Bus equipped fridge is installed, connected and enabled within the system.

The main refrigerator settings can be set / controlled by the EC970 control panel or the Swift Command app. These controls work in parallel with the ones on the fridge control panel, so the settings can be changed by either method.

The related control panel screens are shown below.

For information in using the fridge from the Swift Command app, please see the Swift Command User Guide.

Fridge screen - Here you can select the operating mode, set the cooling setting and view the temperature status.



Dometic Fridge Option

	<p>Power Source - Press a button to select the required power source. OFF – Turn fridge off AUTO – Power source is selected automatically GAS – Set power source to gas 12V – Set power source to 12V battery 230V – Set power source to 230V mains</p>
	<p>Cooling Setting - Use the (+) or (-) buttons to increase or decrease the cooling setting. 1 is low and 5 is maximum.</p>
	<p>Temperature - The display shows the temperature of the fridge, with the optimal (central) position being the ideal. If the fridge is too warm increase the cooling setting to reduce the temperature. If the fridge is too cold, reduce the cooling setting accordingly.</p>
	<p>Frame Heater (if fitted) – Switch on the frame heater to reduce problems with condensation freezing on the fridge and freezer door seals.</p>

Note: The fridge will take time to react to a setting change so please allow sufficient time for the status to update after changing a setting or adding food.

Air-conditioning

If your vehicle has been fitted with a compatible air-conditioning unit then the settings can be set / controlled by the EC970 control panel, the air-conditioner infrared remote control or the Swift Command app. The unit must be turned on with its power switch before it can be controlled.

The related control panel screens are shown

Air-conditioning screen - Here you can select the operating mode, set the target temperature and adjust the fan speed.



Dometic Cooling Option

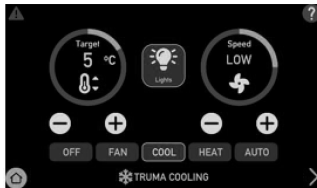

Truma Cooling Option

	<p>Light (if fitted) - Press the lights button to control the LED light built into the air-conditioning unit. The lighting can be set to OFF, ON or DIMMED When the dimmed icon is selected, light is controlled by other dimmable lighting in the vehicle.</p>
	<p>Mode - Press a mode button to select the required operating mode. OFF - Turn air-con off AUTO - Cooling or Heating Mode set automatically DRY - Dehumidifier Mode. User sets temperature, fan speed is automatic COOL - Cooling Mode FAN - Air Circulation Mode (no cooling) HEAT - Heating Mode Note, available modes will vary according to the model of air-conditioner fitted.</p>
	<p>Temperature - Use the temperature setting + or - buttons to increase or decrease the temperature setting. Available settings range from 5 degrees to 30 degrees Celsius.</p>
	<p>Fan Speed - Use the (+) or (-) buttons to increase or decrease the fan speed setting. Note that available settings vary according to the model of air-conditioner fitted.</p>

Electric Step Operation

On vehicles fitted with an electric step, this is operated by a button near the entry door. Press and release the button to move the step in or out. One press of the button will move the step out; a further press will move the step in again.

below. For information in using the air-conditioning from the Swift Command app, please see the Swift Command User Guide.

If the engine is started the step will move in automatically, after a short warning buzzer. If this operation fails due to an obstacle a buzzer will sound continuously to warn that the step is still out, and therefore requires your attention.

System Warnings

The system incorporates a number of warnings that are active at specific times. These are summarised in the table below and also covered by relevant sections of this manual.

Warning screens - When a warning is active a warning screen will appear on the control panel screen containing a description of the warning along with an audible beeping sound.

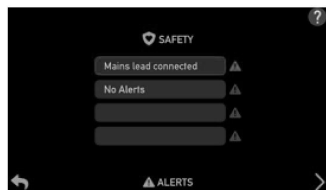



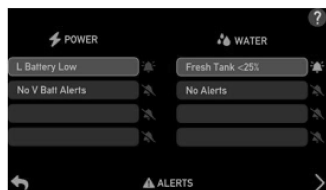



Example safety warnings



Example Power / Water warnings

	<p>Active Warning – If a warning becomes active, it will be highlighted (Orange for power/water alerts and Red for safety alerts)</p>
	<p>Muting a warning – To mute the warning sound, press the bell icon next to the alert. The icon will then become Grey and the sounder will stop. Note that safety warnings can only be muted by correcting the cause e.g. removing mains lead whilst engine is running</p>
	<p>Clearing a warning – The warning will remain highlighted until it is fully cleared, for example by re-filling the water tank or re-charging the battery</p>

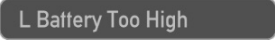
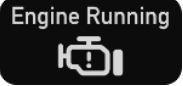
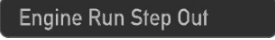
Warning	When	Type
Fresh water level low 	With pump turned on and fresh water level low (less than 25% full) Only available when an on-board tank is fitted	Message on screen and 60 second audible beep
Waste water level full 	With pump turned on and waste water level full. Only available when an on-board tank is fitted	Message on screen and 60 second audible beep
Leisure battery voltage low 	With control panel power on and leisure battery selected (as active battery) and the voltage level falls below 10V	Message on screen and 60 second audible beep.
Leisure battery voltage very low 	With control panel power on and leisure battery selected (as active battery) and the voltage level is below 9V	Message on screen and 60 second audible beep. If no action taken after 30 seconds, then the system will switch the power off to prevent severe discharge of the battery
<p>ⓘ Note: This is an emergency cut off level to protect the battery from severe damage. You should not rely on this cut off level during normal operation, but manage your power consumption to a discharge level of 11.5V or above.</p> <p>This cut off only applies to power drawn from the battery by the leisure equipment that is controlled by the control panel power switch; it will not protect the battery from discharge by permanently connected equipment.</p>		

Warning	When	Type
Leisure battery voltage high 	With control panel power on or off and leisure battery is selected (as active battery) and the voltage level rises above 15V	Message on screen and repeated beeps from the control panel. The power is automatically turned off. The beeping will not stop until the fault is cleared.
Vehicle battery warnings	If the vehicle battery is selected instead of the leisure battery, then similar warnings to those described above are applied to the vehicle battery. The vehicle battery low warning level is 10.9V	
Engine running 	When the engine is started the system power will be turned off	Message on screen stating 'engine running'.
Step extended 	Step extended and engine started Step jammed or obstructed	Message on screen and warning buzzer
Mains lead (hook-up cable) still connected / plugged in 	When the engine is started and the mains cable is still plugged in and the charger is switched on	Message on screen and repeated beeps from the control panel. The beeping will not stop until the hook-up lead is removed.
Heating system	When set to control the heating system, the EC970 control panel will show related heating system warnings, which will include the error number and error description	Message on screen and 60 second audible beep. Additional descriptive information is available when using the Swift Command App.
Refrigerator / Fridge Freezer	When set to control the refrigerator, the EC970 control panel will show related warnings which will include the error number and error description	Message on screen and 60 second audible beep. Additional descriptive information is available when using the Swift Command App.





User Settings & Bluetooth Pairing

The EC970 control panel has a number of user settings, which can be accessed by pressing the User Settings button. This screen also displays the software version number of the PSU, Control Panel and the communicator / tracking unit details, if a Sargent EC660 Communication Unit is fitted.

The Bluetooth pairing process is covered below, should you have an EC660 Communication Unit fitted. Further help with Bluetooth pairing is available in the form of a help video which can be viewed on the Sargent website in the Support Information section.

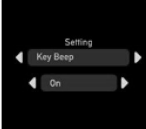
User Settings screen - Here you can set the key beeps, screen brightness, screen on time etc.

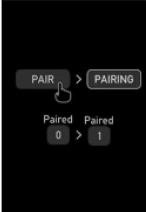

	Settings – Use the arrows to select the setting to adjust, then adjust the setting below as required. Once all required settings have been made, press <i>Tick Button</i> to confirm. (see table below for more detail)
	Reset – Press the <i>Reset Button</i> then press <i>Tick Button</i> to reset setting to factory defaults
	Press the <i>Pair Button</i> to start pairing with your compatible Bluetooth device. The button will change to show PAIRING when pairing is active. You can now pair your device to the system, following the devices instructions. Once paired correctly the <i>Paired</i> box will increment by one e.g., from '0' to '1' Pairing remains active for 1 minute and is then turned off automatically.
	Press the <i>Delete Button</i> to delete any Bluetooth pairings from the system. The button will change to show DELETING until the pairings have been deleted

Section	Possible Settings	Description
Key Beep	On / Off	Turn the key beep sound on or off
LCD Brightness	10% to 100%	Adjust screen brightness
Backlight Time	30 seconds to 1 hour + Always On	Adjust time before screen backlight goes off
Water Alarms	On / Off	Turn the water alarms beep sound on or off
Lighting Mode	None / Lights / Lights & Dimmer	Sets lighting behaviour when control panel is switched on, None – Not used Lights – Normal lights come on. Dimmable lights are off. Lights & Dimmer – Normal lights come on. Dimmable lights come on at the last used dim level setting

8.19 System Technical Information

The following section provides further technical information relating to the electrical system. You can also access the supporting technical manual from www.sargentltd.co.uk

Residual Current Device & Miniature Circuit Breakers



The Residual Current Device (RCD) is basically provided to protect the user from lethal electric shock. The RCD will turn off (trip) if the current flowing in the live conductor does not fully return down the neutral conductor, i.e., some current is passing through a person down to earth or through a faulty appliance.

To ensure the RCD is working correctly, the test button should be operated each time the vehicle is connected to the mains supply (see section 2.3)

The Miniature Circuit Breakers (MCB's) operate in a similar way to traditional fuses and are provided to protect the wiring installation from overload or short circuit. If an overload occurs the MCB will switch off the supply. If this occurs you should investigate the cause of the fault before switching the MCB back on.

The following table shows the rating and circuit allocation for the three MCB's

MCB	Rating	Output Wire Colour	Description
1	10 Amps	White	230V Sockets
2	16 Amps	White (Yellow for heater)	Extra 230V Sockets / Heating System
3	10 Amps	Black (Blue for Whale water heater)	Fridge / Charger / Auxiliary devices / Whale Water Heater

Generator Usage

Caution should be used before connecting a generator to your motorhome.

⚠ WARNING: Never start or stop the generator while electrical loads are connected and switched on. Start the engine, let it stabilise and then connect the electrical load. When stopping the generator, disconnect the electrical load and let engine stabilise before switching off.

Whilst some generators use electronic inverter technology, others use a more basic principle to generate the 230V supply. Preference should be to choose a generator which produces a consistent sinusoidal wave form with accurate voltage control.

The Reverse Polarity warning light on the PSU may illuminate when using a Generator. This is a normal side effect when using some types of generator. Instead of connecting the neutral conductor to earth, some generators centre-tap the earth connection making both neutral and live conductors 110V above earth. This 110V difference causes the neon polarity indicator to illuminate.

In most cases it is safe to use a generator, but please consult the generator handbook for further information.

Battery Charger

The system incorporates an intelligent three-stage battery charger.

During stage 1 the battery voltage is increased gradually while the current is limited to start the charging process and protect the battery. At stage 2 the voltage rises to 14.4V to deliver the bulk charge to the battery. When the battery is charged, the voltage is decreased at stage 3 to 13.6V to deliver a float charge to maintain the battery in the fully charged state. The

charger can be left switched on continuously as required.

The battery charger / power converter also provides power to the leisure equipment when the mains supply is connected. This module supplies DC to the leisure equipment up to a maximum of 25 Amps (300 Watts), therefore the available power is distributed between the leisure load and the battery, with the leisure load taking priority as per the following example:

Leisure load	Available power for battery charging
5A	20A
10A	15A
15A	10A
20A	5A

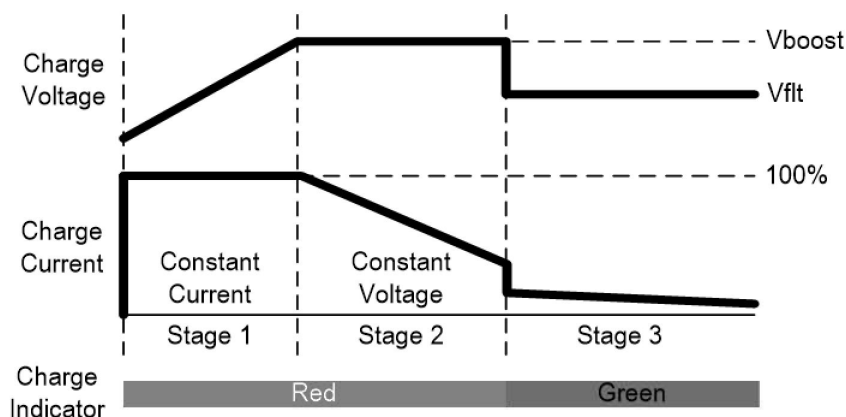

⚠ WARNING: Under heavy loads the Battery Charger case may become hot. ALWAYS ensure the ventilation slots have a clear flow of air. Do not place combustible materials against / adjacent to the charger.

Leisure Battery

A) Type / Selection

For optimum performance and safety, it is essential that only a proprietary brand LEISURE battery is used and it is suggested to select a battery from the NCC Verified Battery Scheme with a typical capacity of 75 to 200 Ah (Ampere / hours). Depending on the prospective use of the vehicle the correct type should be selected (A, B or C). A normal car battery is NOT suitable. This battery should always be connected when the system is in use.

The PSU is configured to work with standard lead acid leisure batteries, and in most cases is also compatible with the latest range of Absorbed Glass Matt (AGM) batteries. The system is also suitable for Lithium batteries with built-in Battery Management Systems (BMS). Before fitting non-standard batteries please check that the charging profile described in 3.3 is suitable for the type of battery by referring to the battery documentation or battery manufacturer.

Some vehicle installations can cater for two leisure batteries connected in parallel. In these cases, it is recommended that two identical batteries are used.

The battery feed is fitted with an inline fuse between the battery and the electrical harness, and is usually located immediately outside the battery compartment or within 500mm of the battery. The maximum rating of this fuse is 20A per battery. If a single battery is fitted this fuse could be up to 40A, however if two batteries are fitted each battery should be fused at a maximum of 20A.

B) Installation & Removal

Always disconnect the 230V mains supply and turn the PSU green charger switch to the off position (button out) before removing or installing the battery.

When connecting the battery, ensure that the correct polarity is observed (black is negative [-] and red is positive [+]) and that the terminals are securely fastened. Crocodile clips must not be used.

Note: If a tracking solution is fitted with an active Thatcham subscription, it is advised to inform the tracking call centre before removing the battery, to avoid an unnecessary security call.

WARNING: Explosive gases may be present at the battery. Take care to prevent flames and sparks in the vicinity of the battery and do not smoke.

C) Operation / Servicing

Under normal circumstances it should not be necessary to remove the battery other than for routine inspection of the terminals and "topping up" of the battery fluid where applicable. Please see instructions supplied with the battery.

Note: Do not over discharge the battery. One of the most common causes of battery failure is when the battery is discharged below the recommended level of approximately 10V. Discharging a battery below this figure can cause permanent damage to one or more of the cells within the battery.

To prevent over discharge, the power control system incorporates a battery protect circuit that warns the users and then disconnects the batteries when they fall below set values.

If a warning is active a beep will be emitted by the control panel and information will be shown on the screen. To mute the warning, press the bell icon. These warnings will not be repeated unless the power switch is turned off and on again. This is to ensure the warning does not become a nuisance.

Battery	Voltage cut off	Action after cut off	Notes
Vehicle	10.9V	Battery selection is changed from Vehicle battery to Leisure battery. If the leisure battery is below 9V then a further warning will occur (see below).	This cut off level is designed to protect the vehicle battery from over discharge. The 10.9V level ensures there is sufficient power in the battery to run the vehicle electronics and start the vehicle. This cut off only applies to power drawn from the battery by the leisure equipment; it will not protect the battery if you leave vehicle circuits switched on, such as the road lights.
Leisure	9V	Power is turned off	This is an emergency cut off level to protect the battery from severe damage. You should not rely on this cut off level during normal operation, but manage your power consumption to a discharge level of about 11.5V. This cut off only applies to power drawn from the battery by the leisure equipment that is controlled by the control panel power switch; it will not protect the battery from discharge by permanently connected equipment.

12 Volt DC Fuses

⚠ WARNING: When replacing fuses always replace a fuse with the correct value. NEVER replace with a higher value / rating as this could damage the wiring harness. If a replacement fuse 'blows' do not keep replacing the fuse as you could damage the wiring harness. Please investigate the fault and contact your dealer.

The following table shows the fuse allocation for the 13 fuses fitted to the PSU. Please note that fuses are dependant on PSU versions, so not all fuses may be present.

Fuse	Rating	Fuse Colour	Description
1	25 Amps	White	Charger
2	7.5 Amps	Brown	Permanent 12V / Alarm / Fridge Electronics
3	10 Amps	Red	12V Sockets / TV Amplifier
4	10 Amps	Red	Extractor Fans
5	5 Amps	Tan	Appliances / Hob Ignition / Toilet / Whale Water Heater
6	10 Amps	Red	Water Pumps / Tank Heaters
7	10 Amps	Red	Lighting, Main Lights & Dim Channel 1
8	10 Amps	Red	Lighting, Entry Light & Dim Channel 2
9	10 Amps	Red	Alde Heating, Truma Heating, Whale Air Heater, Marker Lights, En-Route Sockets & Lights
10	10 Amps	Red	Auxiliary / Awning Light / Electric Step

Fuse	Rating	Fuse Colour	Description
11	10 Amps or 15 Amps or 20 Amps	Red Blue Yellow	Compressor Fridge Supply Under counter Fridge 12V Fridge freezer 12V
12	15 Amps	Blue	Towing 12V
13	15Amps 20Amps	Blue Yellow	Under counter Fridge D+ Fridge freezer D+

① **Note:** Fuses (2-13) have a Red LED below them which provides indication that the fuse has blown. The charger fuse has a green LED which indicates that the charger is working. Fuses 11 and 13 are 10A for compressor fridges, 15A for under counter fridges and 20A for fridge freezers.

The following table shows details of the fuse(s) located at the Leisure battery.

Fuse	Rating	Fuse Colour	Description
Battery 1	40 Amps	Orange	Fuse remotely located near battery
Battery 2	40 Amps	Orange	Fuse remotely located near battery 2 (where fitted)

8.20 Common Fault Table

Fault	Possible Cause	Proposed Fix
No 230-volt output from PSU	Connecting lead between the site and Leisure Vehicle not connected	Check and connect lead as per 2.3C
	RCD switched off	Reset RCD as per 2.3D
	RCD not operating correctly	Check supply polarity; if the RCD continues to fail contact your Dealer as there is probably an equipment or wiring fault.
	MCB switched off	Reset MCB by switching OFF (down position) then back ON (up position), if the MCB continues to fail contact your Dealer as there is probably an equipment or wiring fault.
	No or deficient supply from site	Contact site Warden for assistance.
	Another fault	Contact your Dealer.

Fault	Possible Cause	Proposed Fix
Reverse Polarity light is illuminated on PSU	Mains Supply reversed?	The reverse polarity light is designed to illuminate when the Live and Neutral supply has been reversed / crossed over. If the light illuminates there is a problem with the site supply or the cable connecting the supply to your vehicle. The light is designed to work on UK electrical supplies (where the neutral conductor is connected to earth at the sub station). If you are using your vehicle outside the UK this light may illuminate when no fault exists. In these cases, consult the site warden for advice.
	Generator being used	'The Reverse Polarity warning light is on when using my Generator'. This is a normal side effect when using some types of generator. Instead of connecting the neutral conductor to earth, some generators centre-tap the earth connection making both neutral and live conductors 110V above earth. This 110V difference causes the neon polarity indicator to illuminate. In most cases it is still safe to use the generator, but please consult the generator handbook for further information.
Control Panel Problems	Control Panel has no display	Check batteries and fuses, turn PSU isolate switch and charger switch on and ensure mains supply is connected. Check control panel connecting lead at PSU and behind Control Panel. Contact your Dealer.
	12V Power turns off	Battery protect feature has operated to protect the Vehicle battery and or the Leisure battery. See 3.4C Over voltage protection has been activated, the control panel will display a warning. A number of things can cause this but the most common is the solar panel, it is worth checking the regulator is connected correctly and operating within the correct parameters. Engine has been started; all equipment has been disconnected to meet EMC requirements. See 2.4
	Control Panel locked / erratic function	Observe control panel handling instructions. Control panel software may have crashed. Reboot control panel by turning off the PSU isolate switch. Wait 30 seconds then turn the switch back on. Check with your dealer that your system has the latest software installed, as an update may be available.

Fault	Possible Cause	Proposed Fix
No 12-volt output from PSU	No 230V supply	Check all above.
	Charger not switched on	Turn charger switch on, switch will illuminate.
	Battery not connected and / or charged	Install charged battery as per 3.4
	Power button on control panel not switched to on	Turn power on at control panel.
	Battery flat / Battery fuse blown	Recharge battery, check fuses, check charging voltage is present at battery.
	Fuse blown	Check all fuses are intact and the correct value fuse is installed as per fuse table.
	Equipment switched off / unplugged	Check equipment is switched on and connected to the 12V supply.
	Another fault	Contact your Dealer.
Pump not working	Fuse blown	Replace fuse with correct value as per fuse table.
	Pump turned off	Turn pump on by pressing the pump button at the control panel.
Lights not working	Fuse/s blown	Replace fuse with correct value as per fuse table.
	Lights turned off	Turn Lights on by pressing the lights button, use dimmer at the control panel.
Communications not working	Bluetooth not paired	Using System Settings menu, select Bluetooth Pair option.
	Bluetooth not active on Device	Ensure that the handheld device has Bluetooth switched on and that the device supports the Bluetooth 4 standard (BLE).
	Bluetooth out of range	Ensure the handheld device is within 7M of the middle of the motorhome.

Technical Support

If you require technical support on Sargent products then please visit the Support Customer Support site at <https://sargent.zohodesk.eu/portal/en/home> |

In the Knowledge Base you can view product documentation and search frequently asked questions and in the Ticket section you can raise a ticket to request help from the support team.

Remote Access & Control

Swift Command App

The Swift Command app can be downloaded from the Apple App Store or the Google Play store.

A separate Swift Command User Guide is available which covers the operation of the app. Before you can use the App with your motorhome you will need to create an account and sign up to the free communication service. This is a simple process and will be explained further by your dealer at the vehicle handover. Additional information is available at www.swiftcommand.co.uk

Swift Command Web usage & Description

In addition to the mobile App, you can also use the same account and login details to access the Swift Command web site.

Here you can update and amend your details, look at location information and history, review system information and historical data as well as changing some system options and settings.

Swift Command Subscriptions & Renewal Costs

The EC660 system contains a Mobile SIM with a 36-month contract, which commences upon activation at the Dealership when your vehicle is linked to your customer account or 1 year from the vehicle's date of manufacture, whichever is earlier.

You can add an optional tracking subscription to provide proactive theft monitoring at any time. The price for this will vary depending on how much data subscription is remaining, and the system will add data in 1-year blocks, as required. Visit the Help > Choosing a Subscription page at www.swiftcommand.co.uk for more details of pricing.

Swift Command SIM Coverage & Usage information

Below is a list of the countries covered by the SIM under a fair usage policy, a complete list is available at request.

Austria, Belgium, Bulgaria, Cyprus, Czech Republic, Denmark, Estonia, Finland, France, Germany, Greece, Hungary, Iceland, Ireland, Italy, Latvia, Liechtenstein, Lithuania, Luxembourg, Netherlands, Malta, Norway, Poland, Portugal, Romania, Slovakia, Slovenia, Spain, Sweden, United Kingdom.

For vehicles shipping direct to Australia or New Zealand a special world-wide SIM is fitted at the Swift factory. Please note that if a UK specification vehicle is shipped to these countries the remote features will not operate.

Replacement parts

The EC660 Communication module contains a special rechargeable battery pack which should last in excess of 5 years under normal conditions. The pack part number is 17109 available from Sargent.

Updates

From time to time there may be updates to the system firmware; these updates will be done at service intervals by your dealership.

8.21 Technical Data & Approvals

Equipment – EC601, EC602, EC652, EC653, EC970, EC660 & PX300

Outline Specification		
INPUT 230V	230 Volts / 0 to 16 Amps	+ / - 10%
OUTPUT 230V	RCD protected, 2 x MCB outputs of 10A & 1 x MCB output of 16A Separate switched channels for heating system and charger	
INPUT 12V	2 x 20A battery inputs via 2 x 4-way connectors	
SOLAR INPUT	1 X Dedicated solar panel input capable of supporting 10A of solar power input (typically 180 to 200W) via a 2-way connector	Check the solar panel rating plate to ensure the maximum current is $\leq 10A$
OUTPUT 12V	25A total output via multiple switched channels protected by 13 fused outputs	
Integrated CHARGER	Input 220-240 Volts AC +/- 10%, Frequency 50 Hz +/- 6%, Current 3A max. DC Output 13.6 to 14.4 Volts nominal, Current 25 Amps max (300 Watts).	
Signal INPUT	4 x Fresh water level, 4 x Waste water level, 1 x Engine running, plus multiple vehicle connections, sensor inputs for temperature & humidity	Fresh water negative sensed Waste water negative sensed
Data IN / OUT	CANBUS Data communication and power to Control Panel via 6-way connector CI-Bus Data communication to CI-Bus enabled devices via RJ11/12 connector	
IP rating	IP31	
Operating temperature	Ambient 0 to 35° Celsius Charger case temperature with full load 65° C Max	Automatic shutdown and restart if overheated / overloaded
Dimensions		
EC601, EC602, EC652 or EC653PSU	Overall size (HxWxD) 180 x 305 x 135mm Clearances 75mm above, 50mm left & right	Weight 3.8 Kg
EC970 Control Panel	Overall size (HxWxD) 122 x 190 x 25mm Cut-out size (HxW) 115 x 181mm	Fixing via hidden spring clips Weight 290g
EC660 Comms Module	Overall size (HxWxD) 42 x 120 x 89mm	Weight 400g
EC850 Sensor	Overall size (HxWxD) 20 x 35 x 38mm	Weight 10g

8.22 Approvals

System: BSEN 1648-1, BSEN1648-2 compliant, BS7671: 2018 compliant

Residual Current Device: RCD 40A 30mA trip to BS EN 61008

Miniature Circuit Breakers: MCB's type C 6000A breaking capacity to BSEN 60898

Electro Magnetic Compatibility (EMC) directive 2004/108/EC Certificate CE20071224-1

Integrated Charger: BS EN 60335-1/2.29, 2006/95EC, IEC61000-3.2/3:1995, 1.

Low Voltage Directive: 2006/95EC TUV-014900-A1, EN55022, Class B, EN55024/ Level 2

Declaration of Conformity

Equipment: Leisure Power Control System
Model name: EC601, EC602, EC652, EC653, EC970, EC660 & PX300

I hereby declare that the equipment named above has been designed to comply with the relevant sections of the above referenced approvals. The unit complies with all essential requirements of the Directives.

Signed	Name	Position	Manufacturer
	IL Sargent	Technical Director	Sargent Electrical Services Ltd Unit 35, Tokenspire Business Park Woodmansey, Beverley East Yorkshire, United Kingdom
Date:			

Whilst every effort has been made to ensure the accuracy and completeness of this document, no guarantee is given against errors or omissions. This document may be updated / improved over time therefore please check with your dealer / supplier for update information or visit www.sargentltd.co.uk

8.23 Motorhome battery

⚠ WARNING: Use precaution when removing or replacing the battery, as batteries contain acid liquids which can cause severe injuries and damage when handled incorrectly. Refer to the cleaning and maintenance section. Please also take into consideration when manoeuvring a battery, that the weight may be in excess of 20kg.

Your motorhome has been fitted with one or two leisure batteries depending on size of vehicle and expected electrical loads. The battery will be housed in one of two ways:

Within a floor mounted compartment



Retained beneath the drivers seat or rear seating



Floor mounted compartments are designed to hold the battery securely and to contain any electrolyte (acid) spillage. They are sealed from the habitation compartment and a breather pipe is fitted to ensure any build up of explosive gases (hydrogen) is vented to the outside. If a breather pipe is fitted it is important to ensure that any replacement batteries are also fitted with a breather pipe. The battery or batteries should only be positioned in the appropriate compartment, and be properly secured before travelling.

ⓘ Note: The batteries fitted to your motorhome in floor mounted compartments must be kept upright.

When a leisure battery has been factory installed below the driver's seat or under a seat base, the battery type used is specific to that installation, and is of a type (Sealed AGM) that allows a battery to be installed in a vertical or horizontal orientation. Due to the construction of this type of battery, it is not necessary to vent the battery to the outside, and there is no requirement to check and maintain electrolyte levels.

⚠ WARNING: For your own safety, do not store anything other than the leisure battery in the battery compartment under the drivers seat.

Battery removal

Step one

Remove the lower front seat fascia by pulling on the clip feature located centrally on the upper edge of the fascia. Using a small amount of the force the fascia can be pulled in upwards direction to fully detach it from the two lower clip positions.

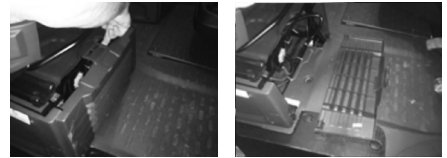

Step two

Release the battery harness by carefully cutting the zip ties which are securing it to the lower seat frame. Then disconnect the battery harness connector by pulling firmly on each of the large black connector plugs.



Step three

Remove the two fabric straps by loosening the straps through the buckles.

**Step four**

Pull the battery forward out from under the seat frame.

**Step five**

Carefully cut through the zip ties which are securing the battery terminal covers in place and remove the covers. Demount the battery terminals using a 10mm spanner taking care not to short the terminals.

**Battery replacement****Step one**

Place the new battery on the cab floor and remount the battery terminals using a 10mm spanner, taking care to observe the positive and negative terminals. Refit the terminal covers and secure in place using new zip ties.

**Step two**

Ensuring that the buckle are face down. Feed the two fabric straps under the lower front and back bars. Hook the rear of the strap over the front top bar – this will prevent the strap being dragged backwards when sliding the battery into place.

Step three

Lie the battery on its side with the terminals closest to the floor. Slide the battery into position taking care not to drag the straps backward.

**Step four**

Reach up above the battery and up through the centre of the seat base to draw the strap back from the top bar. Now the strap is located on top of the battery re-secure the straps through the buckles.



Step five

Tighten the strap as far as possible then slide the seat forward and passing the tails through the hole in the seat base. Then fully tighten the straps and place the tail straps under the seat when fully tightened. Ensure that the straps are located next to the battery terminals to limit movement of the battery.

**Step six**

Reattached the battery harness by firmly pushing the electrical connector back together, stow cable and secure using zip ties across the front the seat frame.

Step seven

Reattach the lower front seat fascia by pushing into lower clip positions first then rotating the fascia until the upper central clip engages.

Note: If an AGM battery is replaced, it must be replaced by an equivalent AGM battery which is suitable for a horizontal installation, and does not require venting to the outside.

It is recommended that a good quality leisure battery is always connected when the motor home electrical system is in use. Leisure batteries are a deep cycling rechargeable heavy duty 12v battery designed to provide power for lights and other electrical appliances. It should be remembered that batteries suitable for the electrical demands of a motorhome differ in design from those for use with a car, and whilst the system may operate with a car battery it is strongly recommended that only a rechargeable leisure type battery, maintained in good condition, is used. The battery should be kept topped up (charged) at all times. If two leisure batteries are fitted additional care is needed, as one battery deteriorates this can reduce the lifespan of the other.

Replacement batteries should be a proprietary brand leisure battery with a minimum 75Ah capacity. Replacement batteries should be checked dimensionally before purchasing, to ensure fitment within the battery compartment, as brands vary in size.

WARNING: When connecting the battery, ensure that the correct polarity is observed (black is negative and red/brown is positive) and that the terminals are securely fastened.

Note: Any replacement of an auxiliary battery shall be of the same type and specification as that originally fitted or specified by Swift.

WARNING: If your motorhome is fitted with Swift Command Tracker (by Sargent) which monitors battery voltage. If you plan to disconnect or remove your leisure battery for maintenance or external charging, then please contact the monitoring station before you remove or disconnect the battery. If a leisure battery is not fitted, please also contact the Tracker monitoring station before removing the mains hook up. The Swift Command Tracker monitoring station can be contacted on 0345 6027302.

Under normal circumstances it should not be necessary to remove the battery other than for routine inspection of terminals and (for non-AGM batteries) 'topping up'.

WARNING: Explosive gases may be present at the battery. Take care to prevent flames and sparks in the vicinity.

Your motorhome has been fitted with an in-line fuse between the battery terminal and the power supply unit. Do not use a higher rated fuse as this may cause damage to your motorhome.

WARNING: Switch off all appliances and lamps before connecting or disconnecting the battery. Open flames and smoking are prohibited around the battery compartment.

To preserve the life of your leisure battery and charger please observe the following:

1. Do not leave all 12v lights powered at the same time as this will drain your leisure battery more rapidly.
2. If all 12v lights must be powered together, ensure the battery is 'in-circuit' and that the battery charger is turned on.
3. For optimum performance use the transformer/charger unit with a leisure battery attached.
4. Please note the auxiliary battery or batteries supplied with your motorhome may not be fully charged and should be charged for a minimum of 24 hours before use. Battery performance may be affected by a number of things such as ambient temperature, age, state of charge etc.

Cleaning and maintenance (Driver and rear seating mounted batteries (AGM) and floor mounted battery components).

- Always remove the battery and the power cable before carrying out any maintenance of the product.
- Before removing the clamps switch off all electrical and gas appliances.
- Use a soft cloth or sponge and a non-acid/abrasive detergent when cleaning the battery tray and area.
- Before the camping season or extensive travelling, check the under seat area for wear on fitting and cables and replace if necessary.
- The cleaning of the battery area should only be done after all power sources have been switched off, in order to prevent a hazardous situations.

8.24 Solar panel

Factory fitted Solar Energy System

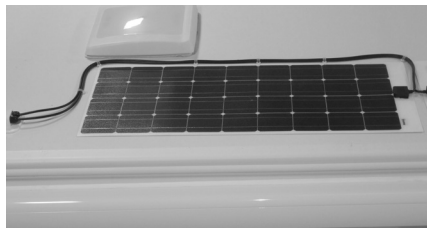

Your motorhome is fitted with a solar panel of up to 200W along with a suitable solar regulator. This solar panel and regulator may provide additional 12V power whenever sunlight is available to the panel which will be directed to the PSU.

Regulator operation

The regulator operates automatically, turning on and off as required to charge and operate. When the solar panel is exposed to a source of sunlight the regulator starts to operate, and the indicators on the solar regulator will indicate the regulator is operating. See the instructions supplied with the regulator for the full description of indications.

Control Panel

When the solar panel is operating the leisure battery voltage display value on the control panel may increase, however this does depend on the amount of load placed on the system and the amount of power being generated by the solar panel at that time.

Charging from Solar Panels

Solar charge directed to the PSU can be distributed to the leisure battery, vehicle battery, or each battery in turn. For further details of selecting which battery receives the solar charge, please see the EC800 or EC400+ instructions. Please note that solar charge can only be directed to both leisure and vehicle batteries, if the System Shutdown button is ON. If System Shutdown is OFF, any available solar charge will be directed to the vehicle battery only.

If the vehicle battery is isolated, for instance via the Fiat battery isolation feature, that battery will not receive charge.

Note: When the PSU System Shutdown button is ON, there will be a small electrical current draw, twenty-four hours a day, on

the selected battery - by default this is the leisure battery. Similarly, if the Fiat or Ford base vehicle battery is connected, there will be a further small electrical current draw on the vehicle battery from the Fiat or Ford systems, twenty-four hours a day. Depending on weather conditions and similar factors, the solar panel and regulator may only be able to provide charge for a few hours a day, which may not be sufficient to maintain the condition of leisure and vehicle batteries. Monitoring of battery state of charge should be done periodically.

Maintenance and cleaning

The solar panel will require cleaning periodically in order to maintain the performance of the panel. A caravan, car shampoo or simple soap can be used, but do not use abrasive cleaners.

8.25 Accessory harnessing

Alarm Power Supply

A connection exists within the motorhome harness, which can be used as a power supply for an alarm or tracking system. For security reasons, information regarding this is not published; please contact your dealer for further information.

Satellite Power Supply

Dependant on specification, in many motorhomes a power supply harness is included for use with roof mounted satellite systems. This power supply is terminated in a 4-way connector marked 'SATELLITE', and carries 12v positive, 12v negative, and a signal which can be used to detect when the vehicle engine is running. (The engine run signal is required by some systems to automatically retract satellite dishes.

Tow Bar Connection

The addition of a tow bar requires an electronic interface to ensure compatibility between the combined road lighting on the motorhome and the trailer, and the road light monitoring system on the Fiat base vehicle.

Your motorhome already features an interface which enables the use of LED road lighting on the motorhome body, and there is connectivity on this device for the addition of a tow bar. It is important that the correct tow bar electrical harness is used, and your Swift Group dealer can order and fit this part for you. If a motorhome is fitted with reverse sensors and a tow bar, these reverse sensors will be disabled when a trailer is connected.

8.26 Generator usage

Caution should be used before connecting a generator to your motorhome.

⚠ WARNING: Never start or stop the generator while electrical loads are connected and switched on. Start the engine, let it stabilise, then connect the electrical load. To stop engine, disconnect the electrical load and let engine stabilise before switching off.

Whilst some generators use inverter technology, others use a more basic principle to generate the 230v supply. Preference should be to choose a generator which produces a consistent sinusoidal wave form with accurate voltage control.

The reverse polarity warning light may illuminate when using a generator. This is a normal side effect when using some types of generator. Instead of connecting the neutral and live conductors 110v above earth. This 110v difference causes the neon polarity indicator to illuminate.

In most cases it is safe to use a generator, but please consult the generator handbook for further information.

8.27 Habitation relay

Habitation relays are fitted to motorhomes by manufacturers to comply with the following legislation:

The Road Vehicles (Construction and Use) Regulations 1986 Regulation 60 - Radio interference suppression

European Community Whole Vehicle Type Approval (ECWVTA) framework directive 2007/46/EC and EU Regulation 661/2009 (General Safety) mandates UNECE Regulation 10 (Vehicles with regard to Electromagnetic compatibility).

A habitation relay must be fitted by manufacturers, safe guarding the consumer, the purpose of the relay is to disable nonhomologated appliances/components whilst the vehicle is in transit.

Unintentional electromagnetic energy can be created by non-homologated devices within the habitation compartment, which could cause a malfunction of the base vehicles electronic systems/components, including safety critical items such as air bags, ABS braking etc.

In your motorhome the habitation relay is within the power supply unit.

8.28 Fault Finding

The Swift Group recommends that electrical fault finding is undertaken by a trained Technician familiar with the systems involved. The basic checks below are therefore limited to items that can be checked without the use of tools etc. If in any doubt please consult a Swift dealer.

Power Supply	
Fault	Remedy
No 230v output from PSU	See EC400+ or Swift Command information as appropriate
Reverse Polarity light illuminated	See EC400+ or Swift Command information as appropriate
Reverse Polarity light illuminated	See EC400+ or Swift Command information as appropriate
Control Panel Problems	See EC400+ or Swift Command information as appropriate
Appliance Not Operating	
Fault	Remedy
Error code or fault light displayed on appliance (eg fridge LCD display)	Check appliance specific information for next steps
No display at appliance controls	Check power supplies are available (electric hook up, charger operating, battery in good state of charge). Majority of appliances will not be operational when engine is running. Ensure control panel is ON. Check appropriate fusing in Power Supply unit
Internal Lighting	
Fault	Remedy
Lighting not operational	Check power supplies are available Check control panel is ON Locate furniture mounted switches, where appropriate Check fuses on Power Supply Unit Determine if light is LED or Tungsten / Halogen bulb, or Fluorescent tube – check and replace bulb, or entire fitting as appropriate

Road Lighting	
Fault	Remedy
Dashboard warning light illuminated / groups of road lights inoperative	<p>If Tow Bar fitted check trailer lighting / disconnect trailer to determine if this is the cause of the fault.</p> <p>Check fuses in base vehicle dashboard or engine bay, see Fiat or Ford handbook for details of which fuses are relevant</p> <p>Check fuse in Power Supply Unit for auxiliary marker lights (Amber side markers, Luton / upper rear markers)</p>

VLM Fusebox

Your motorhome is fitted with a secondary VLM interface, which is designed to work in conjunction with the Fiat base vehicle. The secondary VLM allows the base vehicle to function with the LED rear lights and still inform the user if the directional indicators are functioning or not, via the base vehicle dash.

If a towed trailer is attached to this motorhome then the VLM fusebox will still allow the status of the vehicle directional indicators to be relayed to the user along with informing the user if the directional indicator on the towed trailer are functioning correctly.

Electric Step Operation (When fitted)	
Fault	Remedy
Step will not automatically retract with engine start	<p>Check fuses in Power Supply Unit.</p> <p>Check mechanical condition of step – clean / lubricate if appropriate.</p> <p>Check other functions that are linked to the running of the vehicle engine (i.e. fridge 12v operation). If these are also inoperative contact dealer.</p>
Step does not respond to furniture switch	<p>Check fuses in power supply unit</p> <p>Check mechanical condition of step – clean / lubricate if appropriate.</p> <p>It is possible to link the operation of the step to the lock/ unlock commands from the central locking keyfob. If this feature is enabled on your motorhome, check if operation of the step via the central locking keyfob is possible. To enable / disable the keyfob feature contact your dealer.</p>

Power Supply	
Fault	Remedy
Fresh water level sensor gives incorrect readings	Use floor hatch within motorhome to access top of water tank, or top of tank in bed box if internal (Escape), remove sensor (4-screws) and clean probes If problems persist, dealer assistance required for further fault finding.
Waste water level sensor gives incorrect readings	If possible, from below motorhome remove level sensor from top of waste tank, and clean probes. Alternatively, clean waste tank internal surfaces by flushing through with water or cleaning agent. If problems persist, dealer assistance required for further fault finding.

Battery Discharge	
Fault	Remedy
Leisure battery discharging earlier than anticipated	Have condition of leisure battery checked by dealer or tyre/exhaust/battery specialist If motorhome is not in use, ensure 'SYSTEM SHUTDOWN' button on Power Supply Unit is being used to isolate all circuits If motorhome is in use, see consumption table in handbook – are several items operating simultaneously / is total load likely to cause discharge. Check charger is operational when mains hook up is present, and that the charger is allowed sufficient time to replenish battery / batteries.
Vehicle battery discharging earlier than anticipated	If appropriate to battery, check condition and top-up battery fluid if required Have condition of leisure battery checked by dealer or tyre/exhaust/battery specialist If motorhome is not in use, see base vehicle handbook section headed 'periods of inactivity'. Consider use of vehicle battery isolator If motorhome is in use, check Power Supply Unit is configured to charge / maintain both leisure and vehicle batteries. (Contact dealer for further assistance if unsure)

Audiovisual Equipment	
Fault	Remedy
Rear view camera system inoperative when reversing (if fitted)	Check if camera system can be switched on manually, using power button on rear view mirror, or dash mounted screen.
	Check Reverse Lights are operational on rear of motorhome. (Check base vehicle fuses if reverse lights are inoperative.)
Rear view camera system inoperative whether moving forward or reversing (if fitted)	Check fuses in habitation area fusebox (Power Supply Unit)
Radio switches off intermittently	Radio will not remain on indefinitely when vehicle ignition is switched off. Please see below or the Fiat handbook.

9. Fitted Equipment

9.1 Truma Combination Boiler	144
9.2 Alde Compact 3030 Boiler	150
9.3 Alde Zonal Control	151
9.4 Dometic absorption refrigerator	151
9.5 Voyager / Escape / Ascari Thetford Triplex Cooker	152
9.6 Using the Grill	154
9.7 Maintenance & servicing	156
9.8 Kon-Tiki Thetford K1520	157
9.9 Microwave owner general user instructions	158
9.10 Care of the microwave	160
9.11 Thetford Toilet	160
9.12 Windows	162
9.13 Horrex Window Blinds	163
9.14 Blind Advice	164
9.15 Skyview operating instructions	164
9.16 Escape, Ascari and Voyager cab roof window	165
9.17 Roof lights	165
9.18 Omni-vent	170
9.19 Omni step single step (where fitted)	171
9.20 Thule T4200 / 8000 Omnistor Awning	171
9.21 Reverse Camera System	173
9.22 Cycle racks	174
9.23 Seat swivel (Driver/Passenger)	175
9.24 Heated seats	175
9.25 Side lockers	175
9.26 Aguti Smart Lounge (Escape, Voyager and Kon-Tiki)	175
9.27 Bunk and luton bed safety	176
9.28 Powered Bed Mechanism (model specific)	176
9.29 Lippert Rise and Fall Island Bed (Kon-Tiki)	177
9.30 Tables	178
9.31 Care of laminate tops, tables, furniture and doors	179
9.32 TV inlet	179
9.33 Status 570 Digital antenna system	179
9.34 TV Brackets	180
9.35 Motorhome Wifi (where fitted)	180
9.36 Cab Radios	180
9.39 Shower	181
9.40 Motorhomes with external BBQ point	181
9.41 The External Shower Point	182
9.42 Colour reference	182

① **Note:** The instructions covering fitted equipment to your motorhome were correct at the time of going to print, and where possible, hyperlinks and QR codes have been used, which provide links to online versions of user instructions. Owners handbooks are updated annually and we take great care to try and ensure their accuracy. However, the Swift Group Limited cannot accept responsibility for any changes that may be made in specification or operating instructions to the equipment described in this section after the time of going to press.

Every care is taken to ensure that the information provided in this handbook is correct and easy to understand.

Separate manufacturers' leaflets on many of the components are also included in the Owner's Pack provided with this motorhome and we recommend that you compare the instructions provided via the handbook with the component manufacturers literature, to ensure the information provided is as accurate as possible.

If you are in any doubt as to how to operate the equipment in your motorhome, please contact the component manufacturer's service department on the telephone number shown on their component leaflet. If you remain in any doubt, please contact your supplying dealer.

① **Note:** In the interest of safety, replacement parts for an appliance shall conform to the appliance manufacturer's specifications and should be fitted by them or their authorised agents.

9.1 Truma Combination Boiler



The Truma Combination Boiler can be used in the following ways:

To provide combined room heating and water heating.

- Simultaneous heating of the room, and water contained within the appliance. Often referred to as Winter Mode.

To provide water heating only.

- Heating of the water within the appliance, without room heating. Often referred to as Summer Mode.

To provide room heating only, without water heating.

- If the water system has not been primed, meaning that there is no water within the appliance, it is still possible to use the Combination Boiler to heat the room.

Dual Fuel operation

The Truma Combination boiler has been designed to run on gas or electric power, and the optimum performance is obtained when used in dual fuel mode, that is running on gas and electric at the same time.

Running in dual mode has the following benefits:

- The fastest possible heat up time, as the gas burner combines with an electric element to provide energy to heat your hot water and warm your motorhome.
- The intelligent heat management system automatically senses when the water and room are nearing the required temperature and then automatically turns off your gas burner and operates solely on electric power, conserving your gas.

- As hot water is used or the room cools the Truma combination heater will continue to operate on electric only, until a point where the demands necessitate that additional gas power is also required. An example for such a demand could be for instance if the exterior door was left open and the room temperature dropped by 10 degrees in the space of a few minutes, in this case the intelligent heat management system would decide the best way to get the room back to the required temperature, would be to use both gas and electric at the same time.

Operating the Truma Combination system on electric or gas only will result in longer heat up times for hot water, and room temperature, in comparison to operating on dual fuel.

Operating on electric only may not in all cases maintain a comfortable room temperature especially in colder conditions.

Whilst taking energy consumption and the environment into account, consider using the Combi in Summer mode (water heating only) when room or space heating is not required, but may be needed in the near future. This ensures the appliance is held at the same temperature as the hot water setting chosen, and this can reduce the time taken to provide warm air into the living area, when room or space heating is then selected.

Truma Heating System and Air Flow

The Swift Group undertakes considerable testing of our products in cold chambers to ensure they meet the BS EN 1646 Grade 3 standard and are usable in cold temperatures.

Butterfly outlets

The majority of air ducting outlets on models equipped with Truma Combi heating systems, are of the butterfly type. These may be opened or closed by moving the flap within the fitting, to adjust the balance of the heating output throughout the motorhome. This can help offset differences in blown air output, between outlets close to the heating appliance, and those greater distance away from the heating appliance.

This can also help adjust the temperature of the bathroom, relative to the temperature of the main living area and/or bedroom.

When these butterflies are closed in conjunction with a high heating system output, and therefore a high fan speed, a slight whistling sound can occur. In this case, opening the outlet slightly will reduce or remove the noise.

Closing too many outlets when the heating system is producing a high output, can cause the appliance to reach high operating temperatures. This does not in general terms effect the appliance, but can cause the appliance to automatically shut down. This can cause an interruption of the heating of the motorhome, however heating will resume when the appliance temperatures have reduced to a lower level.

The output of the appliance, and therefore the output of the blown air outlets, will generally be higher when using Gas or Dual Fuel operation. Electric only operation of the heating is rated at up to 1.8kW, whereas Gas (or Dual Fuel) operation is rated up to 4kW (3.8kW) or 6kW (6.9kW), depending which model or Combi is fitted.

The blown air fittings can also be rotated to adjust the direction of air leaving the outlet, as shown in the photo.

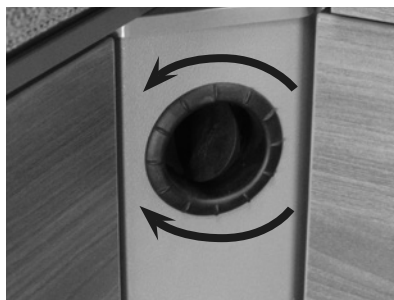

Truma Combination Boiler Control Panel and Appliance Instructions

Please read the user instructions before using the heating system. The instructions include warnings regarding the safe use of the system, and no liability whatsoever can be accepted for damage or injury resulting from failure to observe the instructions.

The heating system can be controlled by the Truma CP+ controller above the entrance door, or, if Swift Command is fitted, the Swift Command control panel, App and remote control features.

For Swift Command functions please see the Swift Command literature and details within this handbook.

For use of the CP Plus controller, and general user instructions for the heating system appliance, please read the Truma information available at the following locations:

CP Plus Controller

<https://bit.ly/3Mj1GSy>



Combi 4 Gas/Electric and Combi 6 Gas/ Electric appliances

<https://bit.ly/3p5H1pG>



<https://bit.ly/3SC9Sja>



Electrical Operation of Truma Combination Boiler

Before the heating system is used for heating using electrical (230v) energy, the 230v isolation button on the Sargent Power Supply Unit must be switched ON, as shown in the image below. To confirm a supply is available, the button will be illuminated when a power supply (mains hook up) is connected and the button is ON.

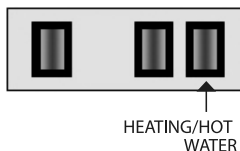

Troubleshooting instructions (Combi heater)

In the event of a problem occurring, a warning or error code will be displayed on the Truma CP Plus control panel, along with a warning triangle. Further warning information will also be displayed on the Swift Command control panel.

The Truma combi boiler (heater and water) has two styles of error code warnings which are shown on the CP+ display panel. Depending on the nature of the fault, the boiler will require resetting in a slightly different manner, depending on the fault.

- Solid error warning code
- Flashing error warning code

Before trying to reset any faults please check that the 12v supply is on, and depending on which energy source is going to be used for heating, either mains electricity is available and switched on, and/or that the gas bottle is open and ready to dispense gas.

The following table on the next page describes causes and remedies to the various fault codes that may be displayed on the Truma control panel.

Once the fault has been rectified the fault can be reset via the control panel

SOLID CODE

Using the control dial on the cp+ panel scroll down to the bottom line where the triangle appears.

- Press this button to acknowledge the error
- The error code and triangle should disappear if the fault has been rectified

FLASHING CODE

- Scroll round (as above) to acknowledge the error on the panel
- Leave the panel UNTOUCHED for 15 minutes – This allows the user to check that fuel sources are available, and is a regulatory time frame
- After 15 minutes the triangle will become solid
 - The panel can be reset as per the above process for SOLID

If the CP+ panel is reset 5 times, without the fault being rectified the fault will become a 'FLASHING' CODE and will be locked for 15 minutes. If the control panel (cp+) is touched within 15 minutes, the 15 minute 'count' will restart. It is imperative that the panel is left untouched during this time.

Truma Customer Service can be contacted on 01283 587960 or technical@trumauk.com if you require further assistance.

Error code	Cause	Remedy
#17	Summer mode with empty water container	Switch heater off and allow to cool. Fill boiler with water
#18	Warm air temperature exceeded:	
	Not all warm air ducts are connected	Check whether the 4 warm air ducts are connected
	Circulated air intake blocked	Remove the circulated air intake blockage
#21	Room temperature sensor or cable faulty	Inspect the room temperature sensor cable, replace if faulty
		Check the resistance of the room temperature sensor. 15°C - 16.2 kOhm / 20°C - 12,6 kOhm / 25°C - 10.0 kOhm
		Replace room temperature sensor if faulty
#24	Risk of low voltage. Battery voltage is too low < 10.4V	Charge battery
#29	Frost Control heating element has a short circuit	Disconnect heating element plug from electronic control unit. Replace heating element
#42	Open window above cowl (window switch)	Close window
#43	Overvoltage > 16.4V	Check battery voltage / voltage sources such as the charger
#44	Low voltage. Battery voltage is too low <10.0V	Charge battery. If necessary replace old battery
#45	No 230 V operating voltage	Restore 230 V operating voltage
	230 V fuse defective	Replace 230 V fuse (see Combi operating instructions)
	Overheating protection has been triggered	Reset overheating protection (see Combi operating instructions)

Error code	Cause	Remedy
#112	Gas cylinder empty	Replacing a gas cylinder
#121 #122 #202	Gas cylinder or quick-acting valve in the gas supply line closed	Check gas supply and open valves
#211 #212	Gas pressure regulation system iced up	Use regulator heater (EisEx)
	Butane content in the gas cylinder too high	Use propane. Butane is unsuitable for heating, particularly at temperatures lower than 10 °C.
	Combustion air infeed or exhaust outlet is sealed	Inspect openings for obstructions (slush, ice, leaves, etc.) and remove any obstructions
	Gas pressure regulation system faulty	Inspect / replace gas pressure regulation system
#255	Heater has no 12 V power supply	Ensure 12 V power supply
	No connection between heater and control panel	Make connection between heater and control panel
#301 #417	Overvoltage > 16.4 V	Check battery voltage / voltage sources such as the charger
#303 #411	Risk of low voltage. Battery voltage is too low < 10.4V	Charge battery
#401	Summer mode with empty water container	Switch heater off and allow to cool. Fill boiler with water
# 402	Open window above cowl (window switch)	Clode window
# 407	Overvoltage > 16.4V	Check battery voltage / voltage sources such as the charger
# 408	Low voltage. Battery voltage is too low <10.0V	Charge battery. If necessary replace old battery
# 412	No 230 V operating voltage	Restore 230 V operating voltage
	230 V fuse defective	Replace 230 V fuse (see Combi operating instructions)
	Overheating protection has been triggered	Reset overheating protection (see Combi operating instructions)
# 419	Gas cylinder empty	Wait 15 minutes and reset fault

Truma Combi Heating fault codes 507, 516 or 517.

This fault will appear in the display of the Truma Combi digital display in the Truma CP Plus control panel. This is a preventative measure to stop the heater constantly trying to restart if there is no gas and is referred to as 'gas lockout'.

ⓘ Note: If the fault 507, 516 or 517 is displayed in the heater's control panel, switching the control panel on and off does not help. This does not delete the fault, but blocks the heater for 15 minutes. The heater is also blocked for 15 minutes if the fault 507, 516 or 517 is deleted four times without the gas supply being established.

# 514	The 12V supply has been interrupted	Ensure the control panel of caravan / motorhome is switched on. Ensure charger is switched on and / or battery is connected
# 507	Gas cylinder empty	Replacing a gas cylinder
# 516 # 517	Gas cylinder or quick-acting valve in the gas supply line closed	Check gas supply and open valves
	Gas pressure regulation system iced up	Use regulator heater (EisEx)
	Butane content in the gas cylinder too high	Use propane. Butane is unsuitable for heating, particularly at temperatures lower than 10 °C.
	Gas pressure regulation system faulty	Inspect / replace gas pressure regulation system
	Gas pressure regulation system faulty	Inspect / replace gas pressure regulation system
	Gas supply interrupted	Restore the gas supply, for example by connecting a full gas cylinder. Then confirm or delete the fault code by tapping the rotary push button. Please note that the first tap might only activate the backlighting of the control panel. The heating then starts automatically if there is a heating requirement. The fault code 507, 516 or 517 flashes because the heater is still in a 15-minute blocking time. This was possibly caused by the heater control panel being switched off or because the heater's 12-Volt supply was interrupted. The heater is also blocked for 15 minutes if the displayed fault is deleted four times without the gas supply being restored. <ul style="list-style-type: none"> • Wait out the 15-minute blocking time for the heater. During this time, do not switch off the heater's control panel and also do not interrupt the power supply. • As soon as the heater's blocking time has expired, the fault is then displayed permanently rather than flashing. It can now be deleted as described in the point above
# 607	Max. number of fault resets reached	Wait 15 minutes and reset fault
# 621	Room temperature sensor or cable faulty	Inspect the room temperature sensor cable, replace if faulty Check the resistance of the room temperature sensor. 15 °C - 16.2 kOhm / 20 °C - 12.6 kOhm / 25 °C - 10.0 kOhm Replace room temperature sensor if faulty
# 624	FrostControl heating element has a short circuit	Disconnect heating element plug from electronic control unit. Replace heating element

If these measures do not remedy the fault or if fault codes are displayed that you cannot find in the troubleshooting guide, contact Truma Service.

9.2 Alde Compact 3030 Boiler



The Alde Boiler can be used in the following ways:

To provide combined room heating and water heating.

- Simultaneous heating of the room, and water contained within the appliance.

To provide water heating only.

- Heating of the water within the appliance, without room heating.

To provide room heating only, without water heating.

- If the water system has not been primed, meaning that there is no water within the appliance, it is still possible to use the Alde 3030 to heat the room.

Alde 3030 Control Panel and Appliance Instructions

Please read the user instructions before using the heating system. The instructions include warnings regarding the safe use of the system, and no liability whatsoever can be accepted for damage or injury resulting from failure to observe the instructions.

The heating system can be controlled by the Alde 3030 colour touch screen controller fitted above the entrance door, or, if fitted, the Swift Command control pane, App and remote control features.

For Swift Command functions please see the Swift Command literature and details within this handbook.

For use of the 3030 colour touch screen control panel, and the 3030 system appliance, please read the information available at the following locations:

3030 Alde Heating System

<https://bit.ly/3QfBlpg>



Electrical Operation of Alde 3030 Heating System

Before the heating system is used for heating using electrical (230v) energy, the 230v isolation button on the Sargent Power Supply Unit must be switched ON, as shown in the image below. To confirm a supply is available, the button will be illuminated when a power supply (mains hook up) is connected and the button is ON.



Heating/Hot
water

9.3 Alde Zonal Control

The Kon-Tiki range of motorhomes is fitted with a second thermostat, which can be used to control the heating system.

In normal use (and on other ranges), the room temperature is measured by a sensor within the Alde touch screen control panel. With the Zonal control, it is possible to select room temperature measurement at this control panel position, or, via the secondary temperature sensor fitted in the rear lounge or sleeping area.



Typical 2nd thermostat and switch installation

The 2nd sensor is a circular furniture mounted device, which has the word 'Alde' embossed on its surface. Next to the sensor, a Black round switch will feature '0' and '1' markings.

With the switch in the '0' position, the room temperature will be measured at the Alde touch screen control panel.

With the switch in the '1' position, the room temperature will be measured at the 2nd temperature sensor position.

9.4 Dometic absorption refrigerator

Before you start using the refrigerator, please read the operating instructions carefully.

These instructions provide you with the necessary guidance for the proper use of your refrigerator. Observe in particular the safety instructions. Observation of the instructions and handling recommendations is important for dealing with the refrigerator safely and for protecting you from injury and the refrigerator from damage. You must understand what you have read before you carry out a task.

Keep these instructions in a safe place close to the refrigerator so they may be referred to at any time.

Your motorhome is fitted with an absorption refrigerator from the Dometic range. The exact model fitted varies, and the model fitted can be confirmed by the data label fixed within the fridge compartment. This label will feature a model number in the format RM8406, RMS8556, RML9336L, RMD8556 or similar.

Using this model number, please read the user instructions for the refrigerator, which are available from the following location:

<http://td.dometicgroup.com/swift.php>



If you are unable to view the documents on line, please contact the supplier, your dealer or Swift for an electronic or paper copy.

Note: Gas operation of fridges – gas lockout

If the fridge makes three unsuccessful attempts to switch to gas mode, further action may be required before gas operation is possible. This could occur if a gas bottle is empty, or if the fridge is switched on before the valve on the gas bottle is opened. The display on the fridge will show flashing LED's against the gas symbol and the warning symbol.

If this does happen, first check that a gas supply is available: After checking the valve on the gas bottle is open, and that the taps on the gas manifold are in the correct position, light one of the gas burners on the hob for a few seconds to confirm gas is available.

Next, at the fridge, press the power ON/OFF button for 2-3 seconds until the fridge beeps, this will clear the warning, and normal automatic selection of energy sources will resume. If the button is pressed for slightly longer, the fridge will switch off. In the event of this happening, simply use the same power button to turn the fridge back on, then press again for 2-3 seconds to clear the warning.

Please note the fridge also has a TANK STOP feature, which prevents gas operation for 15 minutes immediately after 12v operation, this prevents the fridge from attempting to light the gas while re-fuelling mid journey. Please take this 15 minute delay into account if the fridge switches from 12v operation to gas operation.

9.5 Voyager / Escape / Ascari Thetford Triplex Cooker

Cooker 3 burner with combined grill and oven / cooker 3 burner + electric (where fitted) hotplate with separate grill and oven

Burner operation

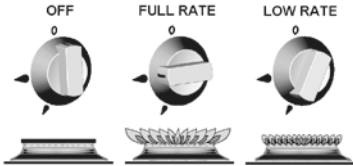

Fig. 1

Important

- Although each burner will support pans from 10 to 22cm, care should be taken not to overload the appliance as performance may be reduced.

- The following pan sizes are the maximum:

- Auxiliary Burner:- Ø200mm Semi-Rapid Burner:- 2x Ø200mm or 1x Ø220mm with 1x Ø180mm

Electric Hotplate:- Ø180mm (except Ascari)

- When using small pans the flames should not spread beyond the base of the pan as this will reduce the efficiency of the burner.
- Avoid old or misshapen pans as these may cause instability.
- The lid must be opened fully prior to using the hotplate burners.

Using the Hotplate Gas Burners

1. Ensure gas cylinder is connected and turned on and the shut off valve at the manifold is open. In the event of a gas smell turn off at gas cylinder and contact supplier.
2. Flame supervision: Each burner is controlled individually and is monitored by a thermocouple probe. In the event of the burner flames being accidentally extinguished, turn off the burner control and do not attempt to re-ignite the burner for at least one minute.
3. To light: Push in the control knob and turn to full rate – see Fig.1. Hold a lighted match or taper to the burner and push the control knob in and hold. It is necessary to hold the knob depressed after the burner has ignited for approximately 10 - 15 seconds, to allow the thermocouple probe to reach temperature, before releasing the knob. Should the flame go out when the knob is released, the procedure should be repeated holding the knob depressed for slightly longer.
4. For models fitted with Spark Ignition the procedure is similar except that the burner can be ignited by depressing the ignition button, which is located on the fascia. If the burner has not lit within 15 seconds the control knob should be released and the burner left for at least 1 minute before a further attempt to ignite the burner.
5. For simmering, turn the knob further anti-clockwise to the low rate position.
6. To turn off: Turn the control knob until the line on the control knob is aligned with the dot on the control panel. Always make sure the control knob is in the off position when you have finished using the hotplate burners.

⚠ WARNING:

Glass lids may shatter when heated. Turn off the hotplate and allow it to cool before closing the glass lid

Remove all spillage from the surface of the glass lid before opening.

The glass lid has the tendency to snap shut towards the end of lowering.

This is caused by the travel lock action of the hinges as it is activated.

Make sure all fingers are removed from appliance when closing the lid.

⚠ WARNING: The use of the gas hobs will generate heat. We recommend, to avoid excess build-up of heat around the cooker area, the window is left opened when cooking to allow for additional ventilation.

⚠ WARNING: Ascari 344:

Do not use the hob unless the bed is lifted to the highest stowage position.

IMPORTANT

- Depending on specification, your appliance may be fitted with a glass lid shut-off system, which cuts off the power to all hotplate burners (gas and electric) if the lid is closed.
- Ensure the glass lid is in the open and upright position before turning on the hotplate burners.
- Not all models are fitted with the shut-off system.

ⓘ Note: The cooker has a glass lid safety shut off switch that turns off the gas hob burners and electrical hotplate, when the glass lid is placed down on the hob. The grill and oven functions will still operate as normal, with lid up or down.

Operation

⚠ WARNING: The grill must only be used with the door open.

On combined grill and oven cookers the heat deflector below the fascia should be pulled out prior to lighting the grill. Never adjust the heat deflector position without using hand protection i.e. oven gloves. See Fig. 2

On separate grill and oven cookers the grill area can get hot when the oven is in use, even if the grill is switched off.

Care should be taken when removing pans from the grill, i.e. use of oven gloves, and by making use of the removal grill pan handle.

Important

- The grill pan supplied is multi functional, for use in grill or oven.
- The handle design allows removal or insertion whilst the pan is in use.
- Always remove the handle when the pan is in use.
- The grill **MUST** only be used with the door open.

9.6 Using the Grill



Fig. 2

1. Ensure gas cylinder/supply is connected and turned on. In the event of a gas smell turn off at gas cylinder/mains and contact supplier.
2. To light: Open door, pull out heat shield (Fig. 2) push in the control knob and turn to full rate – see Fig 1 (page 152). Hold a lighted match or taper to the burner and push the control knob in and hold. The burner should ignite and the control knob should be held in for 10 - 15 seconds before release.

If the burner goes out, repeat procedure holding control knob for slightly longer.

3. For models fitted with Spark Ignition the procedure is similar except that the burner can be ignited by depressing the ignition button, which is located on the fascia. Ignition must be carried out with the door open, and if the burner has not lit within 15 seconds the control knob should be released and the grill left for at least 1 minute before a further attempt to ignite the burner.

ⓘ Note: the grill must only be used with the door open.

4. On first use of the grill, it should be heated for about 20 minutes to eliminate any residual factory lubricants that might impart unpleasant smells to the food being cooked. A non-toxic smoke may occur when using for the first time so open any windows and turn on mechanical ventilators to help remove the smoke.
5. Although the grill does heat up quickly, a few minutes preheat is recommended.
6. Flame Failure Device (FFD): the grill burner is fitted with a flame sensing probe, which will automatically cut off the gas supply in the event of the flame going out. In the event of the burner flames being accidentally extinguished, turn off the burner control and do not attempt to re-ignite the burner for at least one minute.

7. It is normal for the flames on this burner to develop yellow tips as it heats up.
8. A reversible grill pan trivet enables the correct grilling height to be achieved.

Fast Toasting

trivet in high position

Grilling Sausages

trivet in high position

Grilling Steak/Bacon

trivet in high position

Grilling Chops, etc

trivet in low position

Slow Grilling

trivet removed

9. To turn off: turn the control knob until the line on the control knob is aligned with the dot on the control panel. Always make sure the control knob is in the off position when you have finished grilling.

Important:

- The pan supplied with the appliance is multi functional, for use either whilst grilling or when using the oven.
- The handle design allows removal or insertion whilst the pan is in use.

⚠ WARNING: Pans must not touch the glass lid.

ⓘ Note: To avoid heat build up around the hob open the kitchen window slightly to allow the heat to dissipate.

Operation

Important

- If the appliance is fitted with a cooling system. The cooling fans should automatically switch on a couple of minutes after the grill and/or oven is turned on, and will remain on even after the appliance has been switched off.
- The fans should automatically switch off a few minutes after the appliance has been switched off, when the front of the appliance has cooled sufficiently.
- A constant 12V supply is necessary at all times to ensure the cooling system operates correctly.

Using the Oven

1. Ensure gas cylinder/supply is connected and turned on. In the event of a gas smell turn off at gas cylinder/mains and contact supplier.
2. To light: Open door, push in the control knob and turn to full rate (240°C). Hold a lighted match or taper to the burner and push the control knob in and hold. The burner should ignite and the control knob should be held in for 10 -15 seconds before release. If the burner goes out, repeat procedure holding control knob for slightly longer.
3. For models fitted with Spark Ignition the procedure is similar except that the burner can be ignited by depressing the ignition button, which is located on the fascia. Ignition must be carried out with the door open, and if the burner has not lit within 15 seconds the control knob should be released and the oven left for at least 1 minute before a further attempt to ignite the burner.
4. Place the oven shelf in the required position and close the door. Set control knob to approximately 200°C and heat the oven for about 30 minutes to eliminate any residual factory lubricants that might impart unpleasant smells to the meals being cooked. A non-toxic smoke may occur when using for the first time so open any windows and turn on mechanical ventilators to help remove the smoke.
5. Although the oven does heat up quickly, it is recommended that a 10 minute preheat be allowed. The oven should be up to full temperature in about 15-20mins.
6. To turn off: turn the control knob until the line on the control knob is aligned with the dot on the control panel.
7. Shelf: the shelf has been designed to allow good circulation at the rear of the oven and is also fitted with a raised bar to prevent trays or dishes making contact with the back of the oven. To remove a shelf, pull forward until it stops, raise at front and remove.

⚠ WARNING: The pans and trays supplied with this appliance are the maximum sizes recommended for use. Larger pans and trays may restrict good circulation of heat, increasing cooking times.

Oven Temperature Control

The temperature in the oven is controlled by a thermostatic gas tap and is variable over the range 130°C to 240°C. Approximate temperatures for the settings on the control knob are shown in the table below. The temperatures indicated refer to the centre of the oven and at any particular setting the oven will be hotter at the top and cooler towards the base.

The variation between top and centre, and centre to bottom is approximately equivalent to one gas mark. Good use can be made

of the temperature variation in several dishes requiring different temperatures may be cooked at the same time. In this way maximum benefit can be obtained from the gas used to heat the oven. Care should be taken not to overload the oven, adequate spacing being used to allow free circulation for heat.

Operation

Cooking Guidelines

Best results will be obtained by the shelf positions in this guide. It is not necessary to preheat the oven but advisable for a range of dishes. The oven is capable of full temperature in 15-20 minutes.

Most cookery books give details of the shelf positions and gas mark settings for each recipe. If in doubt about a recipe you intend to use, study the recipe carefully then find a similar dish in our guide and use our shelf position and gas mark setting recommendation.

When roasting with aluminium foil care must be taken that the foil does not impair circulation or block the oven flue outlet.

Gas Mark	Temperature (Centre - Shelf Pos. 2)	
	1/4 - 1/2	265 - 275°F
1	285	140
2	300	150
3	330	165
4	355	180
5	385	195
6	410	210
7	430	220
8	445	230
9	465	240

① **Note:** Shelf positions are from the top down.

Do's and don'ts

Do read the user instructions carefully before using the appliance for the first time.

Do allow the oven to heat before using for the first time, in order to expel any smells before the introduction of food.

Do clean the appliance regularly.

Do remove spills as soon as they occur.

Do always use oven gloves when removing food shelves and trays from the oven.

Do check that controls are in the off position when finished.

Don't allow children near the cooker when in use. Turn pan handles away from the front so that they cannot be caught accidentally.

Don't allow fats or oils to build up in the oven trays or base.

Don't use abrasive cleaners or powders that will scratch the surfaces of the appliance.

Don't under any circumstances use the oven as a space heater.

Don't put heavy objects onto open grill and oven doors.

Leaks

If a smell of gas becomes apparent, the supply should be turned off at the cylinder IMMEDIATELY.

⚠WARNING: Extinguish naked lights including cigarettes and pipes. Do not operate electrical switches. Open all doors and windows to disperse any gas escape. LPG gas is heavier than air; any escaping gas will therefore collect at a low level. The strong unpleasant smell of gas will enable the general area of the leak to be detected. Check that the gas is not escaping from an unlighted appliance. Never check for leaks with a naked flame, leak investigation should be carried out using a leak detector spray.

9.7 Maintenance & servicing

Important

- Shut off gas supply at isolating valve, switch off electric supply and ensure all parts are cool before cleaning or servicing
- All servicing must be carried out by an approved competent person.
- After each service the appliance must be checked for gas soundness
- This appliance must not be modified or adjusted unless authorized and carried out by the manufacturer or his representative.
- No parts other than those supplied by the manufacturer should be used on this appliance.
- If the supply cord is damaged, it must only be replaced by the manufacturer or his representative in order to avoid a hazard.

This appliance needs little maintenance other than cleaning. All parts should be cleaned using warm soapy water. Do not use abrasive cleaners, steel wool or cleansing powders.

When cleaning the burner ring it is essential to ensure that the holes do not become blocked. The control knobs are a push fit and can be removed for cleaning. They are interchangeable without affecting the sense of operation.

9.8 Kon-Tiki Thetford K1520

Note: Before using the Hob, Grill or Oven for the first time carefully read the cooking appliance manufacturer's operating instructions supplied with your motorhome.

These instructions provide you with the necessary guidance for the proper use of your Hob, Grill or Oven. Observe in particular the safety instructions. Observation of the instructions and handling recommendations is important for dealing with the appliance safely and for protecting you from injury and the appliance from damage. You must understand what you have read before you carry out a task.

Keep these instructions in a safe place close to the appliance so they may be referred to at any time. For the latest version of the Thetford Manual, please visit:

<https://bit.ly/3BVxIQI>



WARNING:

Appliances and accessible parts become hot during use.

Always use hand protection, e.g. oven gloves, when loading items into or removing them from the oven or grill.

Avoid touching heating elements.

Children less than 8 years of age shall be kept away unless continuously supervised.

Children shall not play with the appliances.

Unattended cooking on a hob with fat or oil can be dangerous and may result in fire.

Never extinguish a fire with water, switch off the appliance and cover flame with lid or fire blanket.

Danger of Fire: Do not store items on the cooking surface.

CAUTION:

- Do not use harsh abrasive cleaners or sharp metal scrapers to clean the hob glass lid or oven door glass since they can scratch the surface, which may result in shattering of the glass.
- Never use a steam cleaner to clean appliance.

WARNING: Before using the appliances for the first time, remove all accessories and packing in the grill and oven, including any surface protection film, i.e. plastic coating.

Gas Operation

Ensure the gas cylinder is turned on and the oven / hob gas isolation valve is open at the manifold. The burners on these appliances have fixed aeration and no adjustment is required. Depending on the gas being used, the burners should flame as follows:

Propane - The flames should burn quietly with a blue/green colour with no sign of yellow tips.

Butane - Normally on initial lighting, as small amount of yellow tipping will occur and then slightly increases as the burner heats up.

Note: For safe use of gas see gas safety advice on page 59

WARNING: The grill must only be used with the door open.

Glass Lids

Depending on specification, your appliance may be fitted with a glass lid shut-off system, which cuts off the power to all hotplate burners (gas and electric) if the lid is closed.

- Ensure the glass lid is in the open and upright position before turning on the hotplate burners.

WARNING:

- Glass lids may shatter when heated. Turn off the hotplate and allow it to cool before closing the glass lid
- Remove all spillage from the surface of the glass lid before opening.
- The glass lid on some models has the tendency to snap shut towards the end of lowering. This is caused by the travel lock action of the hinges as it is activated. Make sure all fingers are removed from appliance when closing the lid.

Do's and Don'ts

- Do** read the user instructions carefully before using the appliance for the first time.
- Do** allow the oven to heat before using for the first time, in order to expel any smells before the introduction of food.
- Do** clean the appliance regularly.
- Do** remove spills as soon as they occur.
- Do** always use oven gloves when removing food shelves and trays from the oven.
- Do** check that controls are in the off position.
- Don't** allow children near the cooker when in use. Turn pan handles away from the front so that they cannot be caught accidentally.
- Don't** allow fats or oils to build up in the oven tray or base.
- Don't** use abrasive cleaners or powders that will scratch the surfaces of the appliance.
- Don't** under any circumstances use the oven as a space heater.
- Don't** put heavy objects onto open grill and oven doors.

⚠ WARNING: The use of the electric hotplate and gas hobs will generate heat. We recommend, to avoid excess build-up of heat around the cooker area, the window is left opened when cooking to allow for additional ventilation. Microwave oven general user instructions.

Ascari Hob and Oven

The kitchen of the Ascari models includes the Dometic CVH1700G Hob and the Dometic OG2000 Oven and Grill. Before you start using these appliances, please read the operating instructions carefully. These instructions provide you with the necessary guidance for the proper use of your appliances. Observe in particular the safety instructions. Observation of the instructions and handling recommendations is important for dealing with the appliances safely and for protecting you from injury and the appliances from damage. You must understand what you have read before you carry out a task. Keep these instructions in a safe place so they may be referred to at any time.

Using this model number, please read the user instructions for the appliance, which are available from the following location:

<http://td.dometicgroup.com/swift.php>



If you are unable to view the documents on line, please contact the supplier, your dealer or Swift for an electronic or paper copy.

9.9 Microwave owner general user instructions

ⓘ Note: Always refer to the microwave operating instructions supplied with the vehicle.

ⓘ Note: Take precautions to avoid possible exposure to excessive microwave energy

⚠ WARNING:

Do not attempt to operate this oven with the door open since open door operation can result in harmful exposure to microwave energy. It is important not to defeat or tamper with the safety interlocks.

⚠ WARNING:

Do not place any objects between the oven front face of the door or allow soil or cleaner residue to accumulate on sealing surfaces.

⚠ WARNING:

If the door or door seals are damaged, the oven must not be operated until it has been repaired by a competent person.

⚠ WARNING:

It is hazardous for anyone other than a competent person to carry out a service or repair operation.

⚠ WARNING:

Liquids or other foods must not be heated in sealed containers since they are liable to explode.

⚠ WARNING:

Only allow children to use the oven without

supervision when adequate instruction has been given so that the child is able to use the oven in a safe way and understands the hazards of improper use.

⚠ WARNING:

When the appliance is operated in the combination mode, children should only use the oven under adult supervision due to the temperature generated (if provided).

Important safety guidance

⚠ WARNING: To prevent fire, burns, electric shock and other warnings. Listed below are, as with all appliances, certain rules to follow and safeguards to assure high performance from this oven.

Important instructions

1. Do not use the oven for any reason other than food preparation, such as for drying clothes, paper, or any other non food items or for sterilizing purposes.
2. Do not use the oven when empty, this could damage the oven.
3. Do not use the oven cavity for any type of storage, such as papers, cookbook, cookware etc.
4. Do not operate the oven without the glass tray in place. Be sure it is sitting properly on the rotating base.
5. Make sure you remove caps or lids prior to cooking when you cook food sealed in bottles.
6. Do not put foreign material between the oven surface and door. It could result in excessive leakage of microwave energy.
7. Do not use recycled paper products for cooking. They may contain impurities which could cause sparks and/or fires when used during cooking.
8. Do not pop popcorn unless popped in a microwave approved popcorn popper or unless it's commercially packaged and recommended especially for microwave ovens. Microwave popped corn produces a lower yield than conventional popping; there will be a number of unpopped kernels. Do not use oil unless specified by the manufacturer.
9. Do not cook any food surrounded by a membrane, such as egg yolks, potatoes, chicken livers, etc., without first piercing them several times with a fork.
10. Do not pop popcorn longer than the manufacturer's directions. (Popping time is generally below 3 minutes). Longer cooking does not yield more popped corn it can cause scorching and fire. Also, the cooking tray can become too hot to handle or may break.
11. If smoke is observed, switch off or unplug the appliance and keep the door closed in order to stifle any flames.
12. When heating food in plastic or paper containers, keep an eye on the oven due to the possibility of ignition.
13. The contents of feeding bottles and baby food jars shall be stirred or shaken and the temperature checked before consumption, in order to avoid burns.
14. Always test the temperature of food or drink which has been heated in a microwave oven before you give it to somebody, especially to children or elderly people. This is important because things which have been heated in a microwave oven carry on getting hotter even though the microwave oven cooking has stopped.
15. Eggs in their shell and whole hard-boiled eggs should not be heated in microwave ovens since they may explode, even after microwave heating has ended.
16. Keep the waveguide cover clean at all times. Wipe the oven interior with a soft damp cloth after each use. If you leave grease or fat anywhere in the cavity it may overheat, smoke or even catch fire when next using the oven.
17. Never heat oil or fat for deep frying as you cannot control the temperature and doing so may lead to overheating and fire.
18. Liquids, such as water, coffee, or tea are able to be overheated beyond the boiling point without appearing to be boiling due to surface tension of the liquid. Visible bubbling or boiling when the container is removed from the microwave oven is not always present.

This could result in very hot liquid suddenly boiling over when a spoon or other utensil is inserted into the liquid.

To reduce the risk of Injury to persons:

- a. Do not overheat the liquid.
- b. Stir the liquid both before and halfway through heating it.
- c. Do not use straight-sided containers with narrow necks.
- d. After heating, allow the container to stand in the microwave oven for a short time before removing the container
- e. Use extreme care when inserting a spoon or other utensil into the container.

9.10 Care of the microwave

1. Turn the oven off before cleaning
2. Keep the inside of the oven clean. When food splatters or spilled liquids adhere to oven walls, wipe with a damp cloth.
3. Mild detergent may be used if the oven gets very dirty. The use of harsh detergent or abrasives is not recommended.
4. The outside oven surface should be cleaned with soap and water, rinsed and dried with a soft cloth. To prevent damage to the operating parts inside the oven, water should not be allowed to seep into the ventilation openings. If the Control Panel becomes wet, clean with a soft dry cloth. Do not use harsh detergents or abrasives on the Control Panel.
5. If steam accumulates inside or around the outside of the oven door, wipe with a soft cloth. This may occur when the microwave oven is operated under high humidity conditions and in no way indicates malfunction of the unit.
6. It is occasionally necessary to remove the glass tray for cleaning. Wash the tray in warm sudsy water or in a dishwasher.
7. The oven cavity floor should be cleaned regularly to avoid excessive noise. Simply wipe the bottom surface of the oven with mild detergent water or window cleaner and dry. The roller guide may be washed in mild sudsy water.
8. The oven should be cleaned regularly and any food deposits removed;
9. Failure to maintain the oven in a clean condition could lead to deterioration of the surface that could adversely affect the life of the appliance and possibly result in a hazardous situation.

9.11 Thetford Toilet

Your motorhome is fitted with a Thetford C260 toilet, which is plumbed directly into the motorhome water system, and does not have its own flush tank. Using the C260 model number, please read the user instructions for the toilet, which are available from the following location:

<https://bit.ly/42QzGfQ>



If you are unable to view the documents on line, please contact the supplier, your dealer or Swift for an electronic or paper copy.

Cassette Toilet Faults

Fault	Remedy
Bowl does not drain when toilet is flushed. Cassette is overfilled	<p>DO NOT REMOVE CASSETTE. While inside the motorhome turn flush knob anti-clockwise to open valve blade and leave it in the open position. Open access door on side of motorhome. Rotate pour-out spout outward. Place appropriate size container under spout cap. Remove cap carefully. Allow bowl contents to drain into container. This will lower the water level in the bowl.</p> <p>Replace cap and return pour-out spout to stored position. DO NOT REMOVE CASSETTE. Go inside the motorhome and turn the flush knob clockwise to close valve blade. Now, the cassette may be removed following the normal removal and emptying procedure.</p>
Odours	Use proper amount of holding tank deodorant specified on bottle.
Toilet tissue does not fit into compartment.	Since some tissues are supplied on larger rolls, it may be necessary to use some tissue before storing into compartment.
Soiled bowl after flushing	Partially fill bowl to cover soiled portion of bowl. Next flush will dissolve waste. Tip: Leave valve blade open during use.
No power to add water to toilet bowl	<p>Check cassette safety sensor switch and fuse-holder for proper engagement and operation.</p> <p>Note: Cassette has to be removed to reach switch and fuse. Insert cassette and try adding water to toilet bowl.</p> <p>Toilet can be flushed manually. Add water. Add water to bowl from a separate container. Turn flush knob anti-clockwise to open valve blade. Turn clockwise to close valve blade.</p>
Cassette cannot be removed	<p>Check for obstacles under retaining clip. Depress retaining clip several times to check operation. Remove cassette. Flush knob and valve blade in partial open position. Close valve blade by moving knob clockwise.</p> <p>CAUTION: If valve blade is open during cassette removal, severe damage to system can occur. Never force insertion or removal of the cassette tank.</p>
Valve blade mechanism sticks or is hard to open	Spray light film of silicone on blade.
Major unit malfunction	Contact your original Motorhome Dealer.

9.12 Windows

Seitz Window Systems

To open, depress the button on the handle and turn the handle, the majority rotate anti-clockwise with one handle on the right stay that will rotate clockwise.

Once all catches are open swivel the window pane open to the desired position.

These positions are set by a ratchet on the stay, it has 3 pre-set positions. To close, open the window all the way past the last position and it will then close.

All opening windows have two catch positions. The first position is for ventilation the second seals the window from ventilation and rain.



Window Friction Stays

Friction stays allow for positioning of window at any point through its opening angle.



Catcher enables three positions of the window. Open position is where the handle is open placed on the outer part of the catcher. If the handle is placed in the middle of the catcher, this is position for ventilating. Closed position is position where the handle is closed on the inner part of the catcher.

Window Condensation

Some windows are not vacuum sealed. Instead the double panes of acrylic plastic are fitted with a breathable plug on the inner pane.

It is possible, in weather where extremes in temperatures occur between night and day, that customer will notice condensation between the panes.

The same phenomenon may also occur when washing your vehicle on a hot day.

The condensation should clear itself when the ambient conditions return to normal and the air between the panes dries. However, if this is taking a longer time than required, the breathable plug (normally located in the top corner of the window) can be removed, with a pin or sharp object, and replaced when the panes are dry. Care should be taken when doing this.



Acrylic (Plastic) Window Cleaning

The material used to produce most motorhome windows is acrylic plastic. While the acrylic used is very durable, it is able to be scratched with relative ease and therefore,

care must be taken when cleaning your vehicle not to use aggressive cleaning products.

Equally, care should be taken when using a drying cloth that it is clean and free from grit.

Plastoform Window System

Within these instructions you will be able to find information to most common questions about correct usage of PLASTOFORM Blanca windows.

While Driving

When vehicle is in motion all windows must be fully closed.

Sun blinds

Never use blind on direct sunlight. If you use the blind on direct sunlight, also for a shorter period, heat will accumulate between window and blind and window may get damaged (will start bending, ballooning).

Cleaning

Never use abrasive and corrosive substances or solvents on windows, such as turpentine, spirit, dishwasher detergents, as they will damage acrylic and/or print. We recommend cleaning with generous amount of water or mild cleaner intended for use on acrylic. Even cleaning with dry cloth can damage the acrylic and leave scratches; always use moist sponge or moist soft cloth. Never clean windows with high pressure washer. Also carwash can damage windows and cause scratches or other damages.

Note: Acrylic material can get scratched very easily, please consider above instructions for cleaning, so that you will not cause scratches or other damages while cleaning.

Condensation

Condensation can appear on the window or between both panes. This is a normal occurrence that appears because of different temperatures inside and outside and properties of acrylic itself. Condensation will disperse after some time. This doesn't mean that there is something wrong with the window or that it is leaking. With properly ventilating the vehicle, you can in most cases prevent also condensation.

Opening and closing the windows

Your windows are equipped with either handles with button or handles without button and stays. Consider the following instruction to avoid the most common damages that can occur:

Handles with button: Always push the button when opening/closing handle.



Stays with knob screw: Always make sure to unscrew the knob before closing the window.

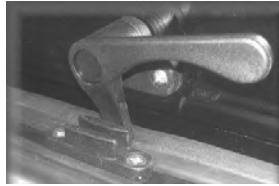

1.1 Open position



1.2 Ventilation



1.3 closed position

Plastoform Blanca windows are top quality windows from acrylic material. If you consider above instructions, your windows can stay in good shape for a long time. Windows also require periodic maintenance and check by your dealer at least once per year.

9.13 Horrex Window Blinds

To operate, pull down or up by holding the finger bar.

- The blind will come up from the bottom of the cassette to close and the flynet will come down from the top
- Only operate by holding the finger(s) - pulling on one side will cause uneven running and snagging.
- It is not recommended that blinds and/or flyscreens are left in the down position for long periods, or when travelling, as this can result in fatigue of the spring.
- Clean the cassette, side track and fabrics with mild detergent and water.
- Lubrication of mechanism or spring is not required or recommended.

For more detailed information, see manufacturer's instructions.

9.14 Blind Advice

In case of prolonged exposure to the sun roller blinds should not be completely closed as this could cause excessive heat concentration at the top of the window, due to characteristics of the glazing material the windows could be adversely affected.

Blinds that shade from the bottom upwards it is necessary to leave a gap of a few centimetres open at the top, this way the heat between window and blind can escape. A fly screen does not cause an obstruction.

Blinds that shade from the top downwards must be kept completely open, or be opened regularly to allow the heat to escape.

Keeping the windows in ventilation position allows heat to escape.

Never fully close a roller blind system when storing the vehicle or when not in use for longer periods!

For vehicles containing blinds from the top downwards or with other types of reflective blinds / curtains, please make sure that these blinds are also ventilated or not fully closed.

Ensure that all windows and roof vents are closed when the vehicle travels on the road.

To adjust the tension of the Horrex blind:

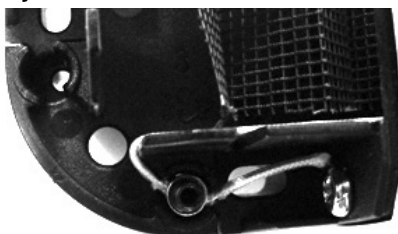

In each corner piece there is an cord tensioner (see photo). By unscrewing the hexagon screw, the cord can move through the cord tensioner. When you pull the cord, the tension will get higher, when you let it move back the tension will get less.

Care instructions:

- Clean the blind only with a damp sponge. Clean on a regular basis to avoid dirt particle build up as this can damage the blind material.
- Use only water or with mild suds or a vacuum cleaner.
- In order to avoid material fatigue, do not leave the flynet closed for a long time.

9.15 Skyview operating instructions

Safety and care instructions

Note: Before opening the dome please check if all handles are disengaged and no objects are in the opening area of the rooflight.

For Manual Skyviews

To open, turn the handle anti-clockwise to the required opening position.



To close, turn the handle clockwise until the dome lies on the seal and a resistance is noticeable.

Note: Before you start your journey, close the rooflight by turning the handles to the closed position and engage catches.

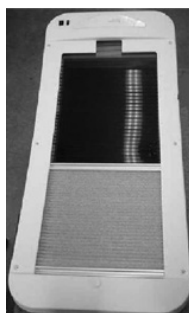

Opening/closing the blind and fly net

Pull the end rod from the recessed part and push it in a position you desire. You can adjust the incidence of light with the second operating bar.

Safety precautions
Repairs should be carried out only by trained personnel.

Inform an approved dealer in case of defects and malfunctions.

9.16 Escape, Ascari and Voyager cab roof window

The roof window on the Escape, Ascari and Voyager is retained in position with window catches.



The retaining catches are as previously described on side window catches and can also be positioned to night vent.

To open the window fully, open all four window catches and push the window up to the required opening height. Tighten the knob screw on the arm of both stays. Close the window if the wind becomes strong or when travelling.

All roof windows and Skyviews

Before starting off, check the roof light for damage in the dome (tension cracks) and the opening mechanism which could arise owing to, for example, branches and other natural causes. Do not put weight on the screen.

Do not leave the vehicle with the roof light open (danger of burglary and water penetration).

Do not open in strong wind, rain or snowfall. Before opening, remove snow, ice, dirt etc. from the dome. Malfunctions must be repaired by an approved dealer at once. Do not use caustic detergents (danger of tension cracks in the dome).

Before setting off close the glazed panel dome and check the locking mechanism.

Avoid high speed (maximum speed recommended is 130 km/h). Do not close the blind more than 2/3 during the day (danger of heat build up). Before starting off, open the blind.

Care instructions

Clean the dome with the Seitz acrylic cleaner.

Opaque spots and light scratches on the dome can be removed with the Seitz Acrylic Polish and the Seitz Special Polishing cloth.

Use talcum powder regularly (4 times yearly) to care for the rubber seals.

Clean the blinds only with water and mild soap suds or a vacuum cleaner.

Note: The guarantee becomes null and void if the care and safety instructions are not followed.

9.17 Roof lights

When opening the roof lights, care must be taken to release the locking mechanism as the unit is raised.

Roof lights must be fully closed when driving. Roof lights provide essential fixed levels of ventilation.

Dometic Mini Heki

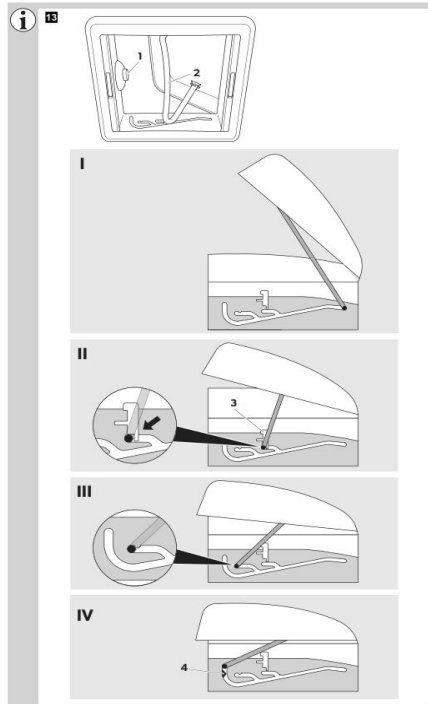

Opening and closing the Mini Heki

Press the release button (1) and open the roof hood with the bracket at the same time (2).

Opening the roof light completely

Slide the bracket (2) into the I position.

Opening the roof light to the half-way position

Slide the bracket (2) into the II position.

You can push down the sliders (3) on the left and right to lock it.

Opening the roof light to the ventilation position

Slide the bracket (2) into the III position.

Closing the roof light

Slide the bracket (2) into the IV position.

Guide the bracket (2) with slight pressure to the left and right via the catches (4), so that the roof hood is locked and the bracket (2) is on the release button (1)

Mini and Micro Heki rooflight (when fitted)



To open depress the button (Fig. A).



Pull the bar down and forwards (Fig. B).



By pushing the bar in to the marked rest positions (Fig. C).

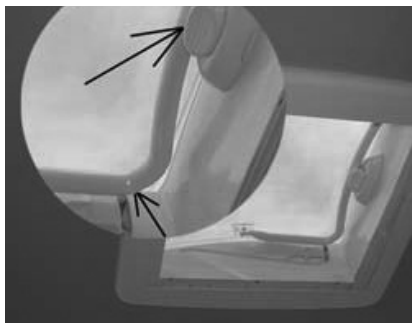

Two extra opening angles apart from the one in which the dome is fully opened can be chosen. The intermediate position can be fixed with a slide marked with the arrows. Care should be taken to ensure the dome is closed and locked for transit with the bar located behind the locking button (Fig. D).

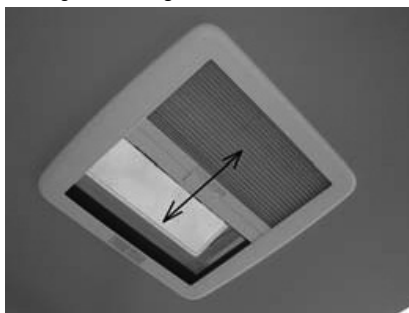

The blind flynet operate together and engage via the clips in the bar, then slide to gain the desired blackout or ventilation (Fig. E).

Midi Heki

Opening the Dome



Intermediate position for the dome

By pushing the bar into the marked rest position, two extra opening angles, apart from the one in which the dome is fully opened, can be chosen.

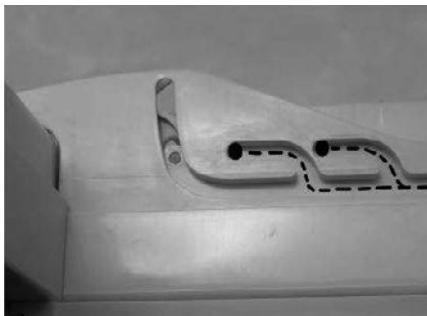

Closing the Dome (drive and rest position)

Push the bar with both hands on the right and the left side in such a way that the hook bolt

1. The dome on the left and the right side and the bar lies on the push button
2. Check if the dome is locked.

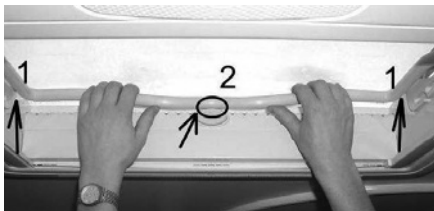

⚠ WARNING: The retaining catches are designed to hold the skylight open to the selected position. In gusty or windy conditions the Skylight should be closed to prevent it from being blown fully open or slamming shut.



With crank

To open, rotate the crank until a resistance is noticeable during the operation.

To close, reverse the operation and then check if locked into position



Electric version

To open, push button until desired position is reached or the electric motor switches off.

To close, reverse the operation and then check if locked into position. Care instructions:

Care instructions:

Please clean the acrylic panes with the Seitz Acrylic Cleaner.

Stains and light scratches on the acrylic pane can be removed by using the Seitz Acrylic Polish and the Seitz special polishing cloth.

Use talcum powder (4 times yearly) to care for the rubber seals

Clean the blinds only with water and mild soap suds

The guarantee becomes null and void if these instructions are not followed. Omnistep single step (where fitted)

MPK Rooflight

(when fitted)

VisionStar M pro ll



Operation



To open the rooflight, both pleated blinds must be open.

Grip the crossbar in the middle and turn it towards the opening side. Now the rooflight can be opened by pushing the crossbar. As soon as you release the crossbar the opening mechanism snaps into this position.

To close the rooflight, turn it again and push it back in the opposite direction. When the end position is reached, the rooflight is locked automatically.

⚠️WARNING:

- Keep the pleated blinds open while driving to avoid driving noise and damage from the airstream.
- To avoid heat accumulation do not close blind completely during the day. Open both pleats when not using the vehicle.

Cleaning

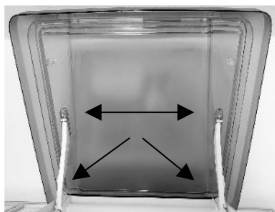

For easier cleaning, the dome can be removed from the inner frame by releasing the four plastic split pins.

⚠WARNING: Do not loosen any screws that are used to fasten the dome or the opening mechanism.

Use only clear water and a soft sponge.

⚠WARNING: Solvents may attack the plastic and make it brittle.

After cleaning, maintain the sliding surfaces with a thin layer of Vaseline or WD40. This makes the extension mechanism glide more easily. The rubber seals can be maintained with talcum powder.

Pay attention that the pins positively click into the locked position when re-installing the dome. The lever arm pins should be re-installed with the flat side towards the dome.

Clean the pleated blinds with a soft brush, dry cloth or feather duster.

⚠WARNING: We strongly advise against wet cleaning, as this can damage the insect screen and blackout pleated blind.

Warranty

The legal warranty applies.

<https://www.mpk-kierspe.de/Downloads>



Care instructions:

The rooflight should only be washed by hand, using a sponge with plenty of clean water to avoid scratching. Caustic detergents and solvents may attack the plastic and make it brittle or disintegrate.

Heki care instructions

Clean the blind only with a damp sponge. Clean on a regular basis to avoid dust/ dirt particle

build up as this can damage the blind material. Use only water or with mild suds or a vacuum cleaner.

In order to avoid material fatigue, do not leave the flynet closed for a long time.

Roof light blind and flyscreen



The blind and flyscreen operate independently of each other and are engaged by connecting to each other and sliding.

Safety precautions:

1. Repairs should be carried out only by trained personnel.
2. Inform an approved dealer in case of defects and malfunctions.
3. Before starting off, check the rooflight for damage in the acrylic dome (tension cracks) and the winding mechanism which could arise owing to, for example, branches and other natural causes.
4. Do not step on the acrylic dome.
5. Close the roof light before starting off (check whether it is locked).
6. Do not leave the vehicle with the rooflight open (danger of burglary or from rain).
7. Do not open in strong wind or rain.
8. Before opening, remove snow, ice, dirt, etc. from the acrylic dome.
9. Malfunctions are to be repaired by an approved dealer at once.
10. Do not use caustic detergents (danger of tension cracks in the acrylic dome).
11. Do not operate whilst the vehicle is moving. Midi-Heki rooflight

9.18 Omni-vent

(when fitted)

To open the roof cover turn the knob in the Omni-vent surround clockwise. Turn anti-clockwise to lower the cover.

CAUTION: The lid must always be closed when travelling.

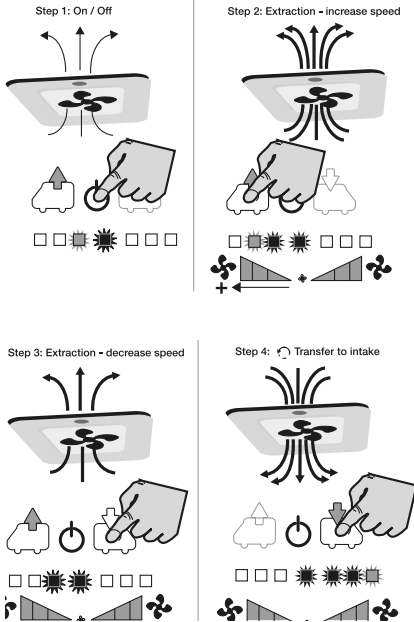

Fan operation

The fan is turned on by touching the on/off soft touch button S2. The middle LED light lights up and the ventilator starts in comfort mode, this is the lowest speed (extract). See fig 18.

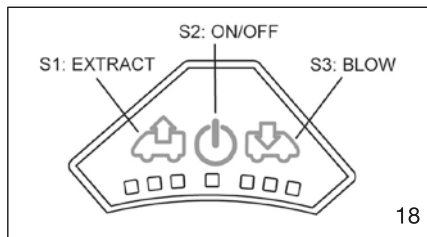

By pushing on the switch S1 (extract) or S3 (intake), the airflow can be adjusted in 6 steps. See table below.

PUSH BUTTONS	LIGHTS	SPEED	Amps	Watt
1x	■ ■ ■ ■ ■ ■ ■ ■	0	0,2 mA	2,4 mW
1x	■ ■ ■ ■ ■ ■ ■ ■	1Q	0,17 A	2 W
1x + 1x	■ ■ ■ ■ ■ ■ ■ ■	2Q	0,48 A	5 W
1x + 2x	■ ■ ■ ■ ■ ■ ■ ■	3Q	0,90 A	11 W
1x + 3x	■ ■ ■ ■ ■ ■ ■ ■	4Q	1,55 A	30 W
1x + 4x	■ ■ ■ ■ ■ ■ ■ ■	5Q	3,20 A	40 W
1x + 5x	■ ■ ■ ■ ■ ■ ■ ■	6Q	7,20 A	85 W
1x + 5x + 1x	■ ■ ■ ■ ■ ■ ■ ■	5Q		
1x + 5x + 2x	■ ■ ■ ■ ■ ■ ■ ■	4Q		
*** ** *	■ ■ ■ ■ ■ ■ ■ ■			
1x	■ ■ ■ ■ ■ ■ ■ ■	0	0,2 mA	2,4 mW

PUSH BUTTONS	LIGHTS	SPEED	Amps	Watt
1x	■ ■ ■ ■ ■ ■ ■ ■	0	0,2 mA	2,4 mW
1x	■ ■ ■ ■ ■ ■ ■ ■	1Q	0,17 A	2 W
1x + 1x	■ ■ ■ ■ ■ ■ ■ ■	0	15 mA	0,2 W
1x + 2x	■ ■ ■ ■ ■ ■ ■ ■	1Q	0,17 A	2 W
1x + 3x	■ ■ ■ ■ ■ ■ ■ ■	2Q	0,48 A	5 W
1x + 4x	■ ■ ■ ■ ■ ■ ■ ■	3Q	0,90 A	11 W

*MIN = 3,7 m3/min (2 W - 0,17 A)

*MAX = 24 m3/min (86 W - 7,20 A)

In order to save the battery, the speed drops from position 6 to the lowest position after one hour of use.

- It is possible to allow the ventilator to work for 5 minutes on the highest speed (boost). To do this push for 3 seconds on the button S1 (extraction) or S2 (intake). After 5 minutes the ventilator returns to its previous speed setting. See table below.

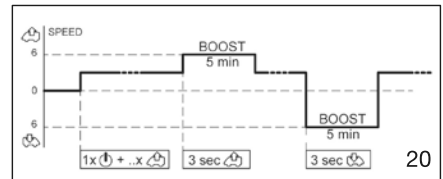

For reasons of security, the ventilator, the ventilator stops when the tension is too high (19,5 V) or too low (11,1 V) or when the fan is blocked. For trouble shooting see fig 21.

Maintenance

The ventilator grid can be removed for cleaning. Also the mosquito screen can be taken out for cleaning.

9.19 Omni step single step (where fitted)

When an Omni step is present, depending on specification, your motorhome is fitted with either a manual or electrically operated step.

Manual operation

When a manual step is fitted, it is operated by manually pulling out or pushing in the step to the desired position.

Electric Operation

The OMNISTEP is operated by the lever switch. Important: when extending the step, hold the switch until the step is completely extended. Never mount the step if retracted or if not fully extended, because then the blocking is not working and the motor can be damaged.

Check if the step is retracted before departure.

Maintenance

Dirt and frost can prevent the step from operating properly. In this case the moving parts should be cleaned or defrosted.

All points of movement are layered in maintenance-free bearings.

In case of electrical failure

If the step does not retract by motor: Loosen the square connection according to fig. 5 (actions 1, 2 and 3), push the footboard in (4) and tie it to the frame.

Current drawn

5 A. When fully extended or retracted: 14-18 A

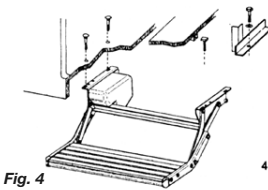

Fig. 4

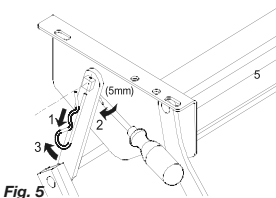
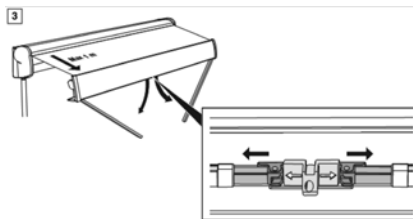
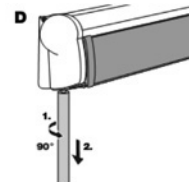
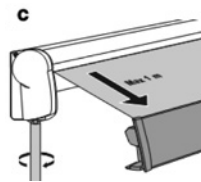
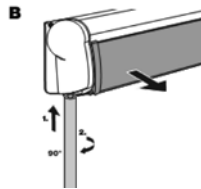
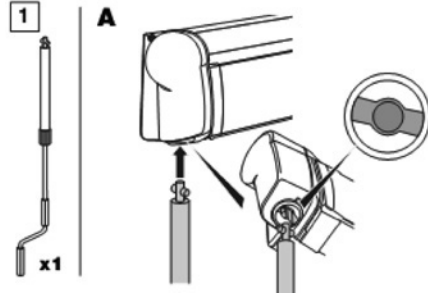
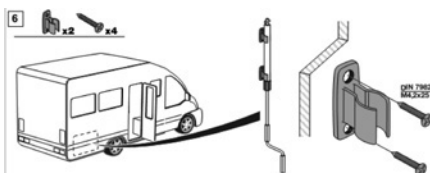
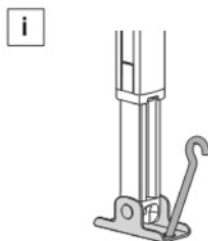
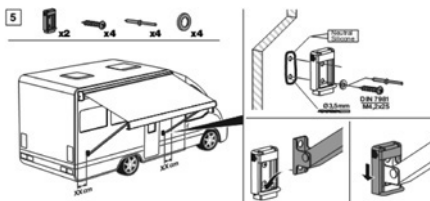
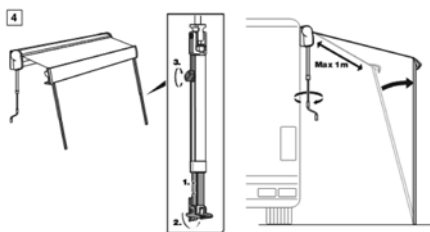

Fig. 5

9.20 Thule T4200 / 8000 Omnistor Awning

- For the mounting height of the bottom mounting brackets ask your dealer.
- An awning is a sun and not an all-weather protection. The awning should be closed in case of storm or high winds, snow or heavy rain fall (avoid formation of a water pocket)





Safari-Residence

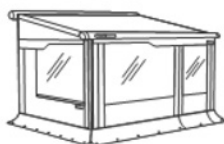

Joint

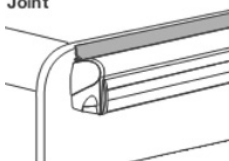

Hold Down Kit



9.21 Reverse Camera System

Depending on the specification of your motorhome, a reverse camera system may be installed. This uses a single or twin lens camera system mounted at high level on the rear of the motorhome.

The camera, or cameras, will be connected to either

1. An LCD screen which forms part of the windscreen mounted rear view mirror (Fiat based motorhomes).
2. A dashboard mounted screen (Ford based motorhomes)

The reverse camera system is powered when the vehicle engine is running.

Single lens camera system

The single lens camera is mounted at high level on the rear of the motorhome. While the engine is running, the image from the camera can be displayed using the controls on either the rear view mirror with LCD screen (Fiat), or dashboard mounted screen (Ford). If Reverse gear is selected, the relevant screen will automatically display the image from the camera.

Twin lens camera system

Two cameras are mounted at high level on the rear of the motorhome. While the engine is running, the image from either camera can be displayed using the controls on either the rear view mirror with LCD screen (Fiat), or dashboard mounted screen (Ford). If Reverse gear is selected, the relevant screen will automatically display the image from the close range camera.

Use of cameras

The rear view camera image may be distracting or disorientating to some drivers and as such extra care and awareness must be observed at all times when using the camera. When reversing a responsible adult should assist in guiding the driver into confined spaces particularly where obstacles or pedestrians may be present or when visibility or lighting levels are reduced.

The mandatory required rear view door mirrors must be maintained and used as the primary rear visibility aid.

The image quality available from the cameras can be affected by dirt, road spray, rain droplets, snow and ice and as such the camera lens will require regular inspection and cleaning. Image quality will be reduced at night-time or by bright lights shone in low level lighting conditions.

Reverse Sensor System

If a reverse sensor system is fitted to your motorhome, this will use a row of sensors fitted at low level on the motorhome, to detect obstacles. The system will automatically switch on when Reverse gear is selected.

A buzzer located close to the driver's seat (within a bed base) will then sound when an obstacle has been detected and is close to the rear of the motorhome. An intermittent tone indicates an obstacle at the maximum distance of the sensors range, and the time interval between tones will reduce as the distance to the obstacle reduces, until a constant tone is heard.

Please consider that the distance is measured from the rear bumper of the motorhome – if an accessory such as a cycle rack is added, the driver must take into account the additional clearance required beyond the bumper, when reversing toward an obstacle.

If a tow bar is installed, this should include a facility to disable the reverse sensor system when a trailer is connected. A tow bar installation featuring this facility can be installed by your Swift Group dealer.

There is a volume control on the buzzer with three settings ON, LOW and OFF.

9.22 Cycle racks



The Swift Group allows the fitment of a two cycle rack carrier and we have made provision for this pre positioned mounting rails fitted to the rear of your motorhome.

These are spaced at various heights as shown on the table on the previous page.

The Swift Group only recommends a Thule cycle rack which will conveniently clip in to the pre installed mounting rail. The maximum weight which can be mounted on the carrier is 50kg.

Please be aware a cycle rack can not be fitted onto a model where there is a rear escape window. Contact your dealer for clarification if your van has a rear window.

Other lifting variants are also available. Please review with your dealer and Thule for the available options.

Thule Bike carrier type		Thule Excellent standard version	Thule Elite G2 standard version	Thule Sport G2 standard version
				
6 Thule reference		309821	306560	307126
Capacity (# bikes)		2+1+1	2+1+1	2+1
Max load (kg)		50	50	50
Max bike weight (kg)		30	30	19
Range	Models			
Ascari	All	✓	✓	✓
Escape & Voyager	All (except Voyager 574 & Escape 674)	✓	✓	✓
Kon-Tiki	All (except 774, 874, 984 and 994)	✓	✓	✓

9.23 Seat swivel (Driver/Passenger)



To turn the swivel, slide the BLACK lever rearwards and adjust to the required angle. Before driving off ensure the locking mechanism is fully secure.

9.24 Heated seats

Your motorhome may be fitted with heated driver and passenger seats in the Fiat cab area. For further details of the operation of these seats, please see the Fiat base vehicle manual.

9.25 Side lockers

Some models are provided with exterior access locker doors. These are suitable for storing external equipment.

9.26 Aguti Smart Lounge (Escape, Voyager and Kon-Tiki)

The front of the Escape, Voyager and Kon-Tiki models, includes the Aguti Smart Lounge with fold-up travelling seats.



The lounge in daytime position

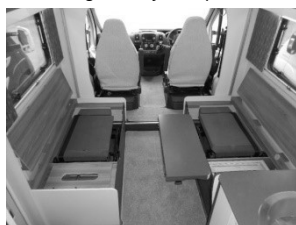

Remove all the cushions. Fold away and lower the table to the bottom position. Slide the table top to rear to allow access in to the seat.



Turn the handle on the side of the seat and lift the seat backrest to the upright travelling position. Repeat on the other side of the van.

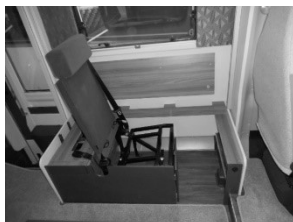

Open the front flap by disengaging the turn button catch and retain open by ensuring the magnetic catch is located on to the metal support frame.

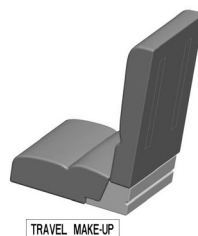

Place the infill make-up cushion on the seat base hard up to the seat back. Place the seat base cushion onto the seat base ensuring that it overlaps the infill make-up cushion and that the Velcro strips engage.

Separate the two halves of the backrest cushion by peeling apart the Velcro strips and place the thicker section against the seat backrest. Route the seatbelt over the top of the backrest cushion and pull out the seatbelt buckle from the base of the seat.

Safely store away all the remaining cushions ready for travel.



To return to the lounge set up the process is reversed.

When folding away the travelling seat ensure the seat is returned to its horizontal position. Do not rotate past the horizontal.

9.27 Bunk and luton bed safety

Where the sleeping surface is over one metre above floor level the following notices apply.

⚠ WARNING: Always ensure safety boards are located before entering the bunk.

⚠ WARNING: Use upper bunks for sleeping only, with the provided protection against fall out in position.

⚠ WARNING: Care shall be taken against the risk of fall out when the upper bunks are being used by children, especially under 6 years of age, these bunks are not suitable for use by infants without supervision.

Layouts with an over-cab bed (luton bed), access may be restricted when the lower bed (model specific) is fully extended at night time.

9.28 Powered Bed Mechanism (model specific)



If fitted to your motorhome, the bed control panel will be positioned next to the main control panel located above the habitation entrance door.

Control Panel Operation

Activate the panel by inserting the supplied key and turning to the 'ON' position. To raise or lower the bed, press the corresponding arrow; UP (arrow up), DOWN (arrow down).

ⓘ Note: The bed can only be operated when the engine ignition is turned off.

The bed will continue to move while the switch is being pressed. It will stop either when the button is released, or the pre-set stop position is reached or the end of the stroke position is reached.

Before lowering, unfasten the safety belts and ensure the bunk net catches have been released.

After raising, fasten the safety belts to secure the bed for transit. Ensure the bed is at the highest position before fastening the belts. The safety belts must always be fastened when the vehicle is in transit.

When the bed is not in use turn the key to the 'OFF' position and remove the key to deactivate the control panel.

⚠ WARNING: The bed operating mechanism should only be operated by a responsible adult. Take care to ensure that all persons, pets and loose items are clear of the top and underside of the bed before operating the lifting mechanism. Do not operate the lifting mechanism with a person or heavy object on the bed. Always remove the key when the bed lifting mechanism is not in use.

⚠ WARNING: Do not touch the lifting system while the bed is being operated. Safety straps must always be fastened when performing maintenance on the lifting system.

Manual Operation

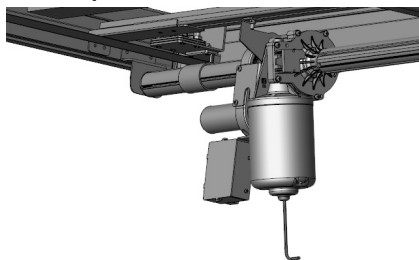

In the event of power failure or an emergency the bed can be operated manually. To access the motor a Pozidriv screw driver is required to remove the screws on the access panel located behind the locker door under the bed. A 5mm Allen key is also required to operate the motor. Insert the Allen key into the motor as indicated in the diagram and turn to lift or lower the bed as required.

⚠ WARNING: Always ensure the power is disconnected before performing any operation on the bed lifting system.

Care points

Care must be taken to remove obstructions which will restrict the full range of movement of the motorised drop-down bed, in particular the safety belts and bunk net catches. If an object is left in the way when the bed is being lowered the motor will continue to run unwinding the belts. If this occurs, immediately stop the operation and remove the obstruction. Once the obstruction is removed raise the bed to re-tension the belts. Once the belts have been re-tensioned the bed can be lowered again.

⚠ WARNING: (ASCARI):

Do not use the hob unless the bed is lifted to the highest stowage position.

9.29 Lippert Rise and Fall Island Bed (Kon-Tiki)

⚠ WARNING: Before using the bed always ensure the safety locking pin is inserted into the use position (fig.a).

On some layouts we have the facility to increase the garage storage area under the rear Island Bed. The bed can be raised or lowered in order to store and remove objects from the storage compartment.



To adjust the height of the bed insert the crank handle into the winding mechanism located underneath the bed in the garage area. It can be accessed through the offside garage door. Ensure there is nothing obstructing the path of the bed and no excess weight on top of the bed before moving.

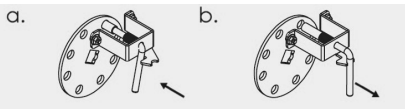

To allow the bed to move, the safety locking pin must be extracted first (fig. b). Then turn the crank handle clockwise to raise the bed height or anti-clockwise to lower the bed height. When the required height is reached insert the safety locking pin (fig. a) and remove the crank handle.

⚠ WARNING: Before using the bed always ensure the safety locking pin is inserted into the use position (fig.a).

9.30 Tables

① **Note:** The free standing table legs have a positive locking mechanism. Care must be taken to ensure that, when folded, the leg which is closed first locks into the second position.

When engaging legs in down position the mechanism must be positively locked down.

⚠ **WARNING:** When erecting the free standing table, be careful to avoid trapping fingers.



Pull out the metal support arm from under the table and unfold the table leaf.

⚠ **WARNING:** Ensure the leaf support is pulled out, before unfolding the table.

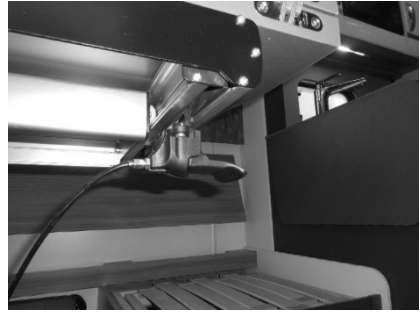

Mapa Electric Telescopic Table leg

① **Note:** Some layouts have a folding table that incorporates an extension leaf to support the table once extended. Slide the extension out before unfolding the table top in order to support it.

The electric retractable table is controlled by a switch on the kitchen pattress. The table top unfolds and has the ability to slide and rotate in to the required position

To rotate and slide the table top, lift the lever underneath the table and move to the desired position.

The storage of the table is the reverse of the above.

⚠ **WARNING:** When travelling the table must be stowed in the lowest position. The table will not function with the engine running.

⚠ **WARNING:** Should the table be forced to move when it is obstructed by something, the fuse may blow and the table will be unable to move. The fuse is located next to the switch in the Kitchen pattress.



Ensuring there are no objects blocking its path and with the table top folded away in its storage position, press the table power switch (located on the kitchen pattress) to the up position and hold until the desired height is reached.

Table storage

Tables stored in the table storage compartment must be securely clipped into place whilst in transit.

To avoid damage care must be taken when removing tables from their stored position.

⚠ WARNING: All non-fixed tables must be stowed in the storage position when the vehicle is moving.

9.31 Care of laminate tops, tables, furniture and doors

Do not use abrasives, chemically treated cloths or aggressive detergents as these may cause damage

Do not place hot objects on laminated surfaces i.e. tops, tables. Any temperatures 70°C and over will cause permanent damage.

Clean worktop surfaces, furniture and door fascias with a soft, slightly damp cloth, dry off with a soft cloth.

9.32 TV inlet

Depending on specification, the motorhome may be fitted with an external co-ax connection and/or a roof mounted TV aerial. When fitted, the external co-ax connection point will be within the mains inlet enclosure.

Co-ax connection point within the mains Inlet enclosure

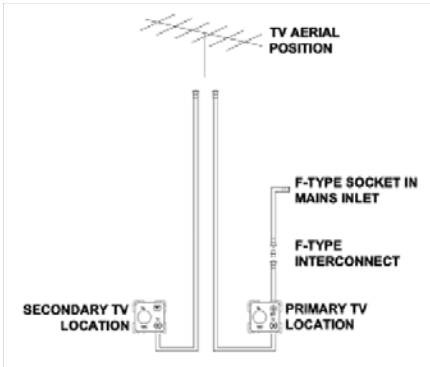

A short co-ax lead featuring a screw on co-ax connection will be present behind the Blue mains inlet connector. A co-ax cable will be fitted and connected within the motorhome, from the back of this connection, to the primary TV position within the motorhome.

At the same time, further co-ax cable or cables will be fitted which route from the TV aerial position (i.e. within the wardrobe) to each of the TV positions within the motorhomes.

The primary TV position will feature a socket marked 12v, TV, and SAT. The co-ax from the

external connection point will route to the socket output marked SAT, whilst the co-ax from the TV aerial will route to the socket output marked TV. At any secondary TV positions (if present) co-ax from the TV aerial will be fitted, and routed to the socket output marked TV.

An external TV aerial or site TV feed can be connected to the external connection point; signals from that connection will then be available at the primary TV position within the motorhome. As the connections are of the screw-on type, it is also possible to use this co-ax to route from an external satellite dish, for instance a tripod mounted dish, to a satellite receiver.

9.33 Status 570 Digital antenna system

Travelling

Do not travel:

- with the antenna raised
- with the antenna set for vertical signals

To reduce the possibility of damage when travelling, point the antenna backwards.

The RED SPOT on the bottom of the mast indicates the front of the Antenna.

Your motorhome may be fitted with a Status 570 TV aerial. Please read the user instructions for the TV aerial, which are available from the following location:

<https://bit.ly/3bFqo0L>



If you are unable to view the documents on line, please contact the supplier, your dealer or Swift for an electronic or paper copy.

After performing any of the 'Actions' above you must re-tune your TV.

9.34 TV Brackets

In some models a bulkhead mounted bracket is supplied to mount the TV on. Whilst the bracket has a travel lock it is good practise to unclip the TV from the bracket and store securely for transit.

9.35 Motorhome Wifi (where fitted)

In some models, a 3G/4G/5G antenna is pre-fitted, which is connected to a MiFi (My Wifi) device. This system connects to the cellular network, and provides a Wifi connection inside your motorhome for up to 10 devices to connect to.

Please check with your dealer whether the MiFi device is fully installed in your motorhome, and whether the SIM card supplied with the device has been pre-installed. The position within the motorhome is layout specific, but typically in a wardrobe or in a cupboard above a fridge/ freezer.



Once the SIM card is installed and components are connected, basic operation is as follows:

- Turn on the power to the device, using the switch on the base of the unit, at the left hand side. A red LED will illuminate, and a charging / battery symbol will appear in the display on the front of the unit.
- Press the power button on the front of the unit. The display will change while the device starts, and once the unit is ready, a network name and passkey will appear on that display.
- Search for Wifi on your mobile phone / tablet / laptop, looking for the network name as displayed on the device. Connect, and when prompted for the passkey/password, use the code as displayed on the screen.

Complete user instructions, including how to fit the SIM card and mount and connect the MiFi device if still required, can be located at the address below. Please read these instructions before using the system.

<http://www.motorhomewifi.com/swift/>



If you are unable to view the documents on line, please contact the supplier, your dealer or Swift for an electronic or paper copy.

9.36 Cab Radios

Fiat based motorhomes

For full details of the features within the Fiat entertainment system, please see the paper copy literature supplied with your vehicle.

The Fiat radio antenna is housed within the passenger wing mirror. Any issues with your radio reception should be referred back to your Fiat dealer.

While specifications are subject to change, power to the Fiat entertainment system is typically turned OFF 20 minutes after the vehicle ignition is switched off.

It is possible to fit an aftermarket radio to the base vehicle, customers should note this may affect steering wheel controls and increase power consumption

Ford based motorhomes

For full details of the Zenec Xzent F-285 entertainment system, please see paper copy literature supplied with your vehicle.

Power to the Xzent unit will be switched OFF, when the vehicle ignition is switched OFF.

An additional switch is located forward of the Xzent unit on the dashboard to supply power to the radio which defaults to the leisure battery as its primary source of power with the ignition switched off.

9.37 Wireless charging pad

If fitted, your motorhome may feature a wireless charging pad in the front lounge area. This pad uses the Qi charging standard, for use with devices that are compatible. The device will need to be positioned appropriately on the pad when charging.

The charging pad is connected to the 12v system within the motorhome, and so is available for use whether or not the 230v mains hook up is connected.

9.38 Shaver socket

If fitted, your motorhome may feature a shaver socket in the bathroom. This socket is supplied from an isolating transformer mounted elsewhere in the motorhome, and is only available for use when the motorhome is connected to a mains hook up (230v supply)

Please note this shaving socket is for plug-in shavers only – it is not suitable for charging devices such as cordless/battery operated toothbrushes or shavers.

9.39 Shower

When using the shower, always ensure that the shower door is fully closed thus avoiding water spray on unprotected areas.

Trigger head shower

- Squeeze trigger to release water. Release trigger to stop. Twist trigger up to gain permanent water flow, lower to stop.
- Orbit shower heads are also provided with a button at the side of the head to allow users to control the flow.
- Care should be taken as water may become hot temporarily when switched on until it mixes and regulates.
- Small children should be supervised at all times when using the shower.
- We recommend unfastening the trigger shower head before travelling and storing safely to prevent it becoming detached whilst travelling.

9.40 Motorhomes with external BBQ point

Models equipped with an external barbeque point can be used to power any gas appliance suitable for the gas used in the motorhome, at the working pressure shown on the label in the barbeque outlet box. Please note when using the outlet that the fitted regulator will allow a maximum of 1.5kg per hour of gas to be taken from the gas bottle. Therefore the consumption of gas from both the appliances within the motorhome and the appliance connected to the barbeque point cannot exceed a total of 1.5kg per hour at any one time. If you are in any doubt please consult your dealer for advice. To use point proceed as follows.

When external gas equipment is being connected, the operating pressure of the gas supply of 30 or 50 mbar must correspond with the operating pressure of the equipment that is being connected (see data plate).

The plug-in connection can only be made if the quick-acting valve is closed. The safety locking mechanism can be released by sliding back the coupling sleeve.

The coupling K-valve is designed such that the quick-acting valve can only be opened if the connection is being made via the plug-in connection. The connection is made by inserting the plug-in connection into the safety coupling.

This operation can be carried out using one hand. After uncoupling the equipment, seal off the valve opening using the protection cap.

Note: The external gas socket is only suitable for removing gas, not for feeding gas into the gas system.

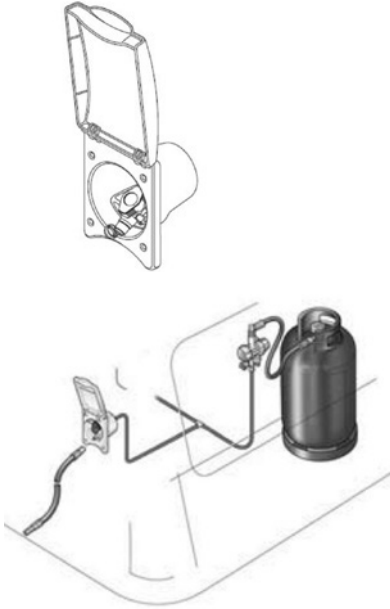

⚠ WARNING: Care should be taken when using the external barbeque point. Never barbeque next to an awning or tent.

⚠ WARNING: The barbeque point should only be used as an outlet point for gas, never connect a gas bottle direct to the outlet.

9.41 The External Shower Point

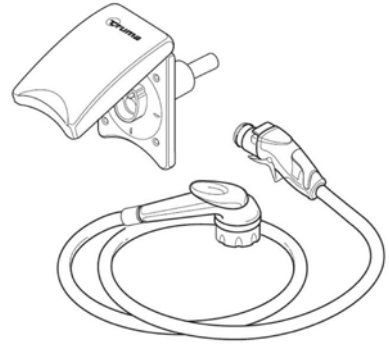

The external shower point if fitted, will be supplied with a separate shower head and hose assembly.

To connect the shower, simply align the plug with the socket and push into position.

To remove, pull the lower trigger and pull the plug from the socket.

9.42 Colour reference

The colour codes for touch ups or resprays for Fiat cabs are Fiat White 249, Lanzarote Grey 385, Metallic Iron Grey 691, Metallic Black 632 and Expedition Grey 676. For the Ford cab the colour is Magnetic Grey FM6EWHA. The white Swift coach built habitational body components are Fiat White 249.

Please be aware that colours can fade over time, and therefore, if the vehicle is more than a few years old, it is suggested a colour match be obtained. If these are small areas that do not require a full respray of the entire panel you can use an over the counter polishing compound to return the original finish. We would always recommend that an inconspicuous area of the motorhome is tested beforehand.

10. Maintenance

10.1 Vehicle modifications & non-standard parts	184
10.2 Motorhome exterior	184
10.3 Condensation	184
10.4 Changing Exterior Bulbs	186
10.5 Motorhome Interior Care	186
10.6 Swift Shield Fabric (model specific)	187
10.7 LED Replacement	188
10.8 Winterisation	189
10.9 Chassis and rear axle	191
10.10 AL-KO exhaust system	191
10.11 Caring for the environment	191

10.1 Vehicle modifications & non-standard parts

As the owner of a Swift Group Product, you are able to make any modifications you wish, either by yourself or through a dealer, without affecting the Swift 3/6 Year Warranty.

However, please be aware that any issues, resulting directly or indirectly, from a modification or fitment of a non-standard part, will not be covered by The Swift Group Warranty.

WD40 is not recommended for external or internal use

WD40 attacks paintwork and sealants.

If a lubricant is required for Interior hinges, Sliding door tracks, Exterior door hinges, Plastic tracking etc. We recommend "Ambersil 40+" this is readily available from most DIY/ Automotive spare part retailers

Before carrying out any DIY work within the warranty period (3/6) years please check with your Swift Group dealer.

10.2 Motorhome exterior

Cleaning

1. Wash the motorhome regularly with mild detergent. Rinse with cold water and leather off.
2. For better protection a similar coloured good quality car wax may be applied.

For sealed areas a mild soap is the best way to clean without affecting the sealant.

Acid or alkaline based cleaners or solvents should not be used.

⚠ WARNING: Under no circumstances use any abrasive cleaning agents or solvents on the exterior. Do not wash your motorhome with a high pressure washer as these can permanently damage the seals of your motorhome. Care should be taken as the silicon in some polishes can attack the rubber used on the exterior for seals and gaskets.

Acrylic Windows

Wash windows carefully, as you would with the paintwork of your car, do not scrub windows prior to removing surface dirt and film with a hose pipe - trapped dirt could cause scratching.

Wash with a solution of warm soapy water, windows can then be dried off with a leather shammy.

Small scratches can be removed, consult your dealer.

Catches and stays do not require any special attention or lubrication.

Acrylic (Plastic) Window Cleaning

The material used to produce most caravan and motorhome windows is acrylic plastic. While the acrylic used is very durable, it is able to be scratched with relative ease and therefore, care must be taken when clearing your vehicle not to use aggressive clearing products. Equally, care should be taken when using a drying cloth that it is clean and free from grit.

10.3 Condensation

What is condensation

Condensation is the process of change of water from its gaseous form (water vapour) into liquid water when it comes into contact with a surface that is cold. Condensation generally occurs when warm air cools quickly and loses its capacity to hold water vapour, and as a result water vapour condenses to form droplets.

Why condensation occurs

Condensation occurs when warm moist air meets a cold surface. The level of condensation will depend upon humidity levels, how moist the air is and how cold the surfaces are they come into contact with.

If the temperature falls below the dew point temperature, it is quite normal for condensation to occur on any material within the motorhome that is cold, for example the external walls, plastic windows etc.

When condensation occurs

Condensation occurs usually in winter months, because ambient temperatures are colder (leading to cold surfaces) and windows and roof vents are opened less so the moist air cannot escape.

Where condensation occurs

Condensation will occur where warm moist air is put into the atmosphere in areas such as in bathrooms (during showering) and in kitchen areas (during cooking).

In the enclosed space of a motorhome, the moist air from the kitchen or bathroom areas will inevitably transfer to the rest of the vehicle, which in turn condenses on cold surfaces leading to visible water droplets. This issue is compounded by warm moist air being generated from normal breathing.

Condensation will also form in cold areas where air movement and ventilation is restricted (e.g. cupboards, wardrobes, under beds, etc.)

What is important

It is important to provide ventilation and air flow, so that warm moist air can escape, or be externally cooled, and to use the heating reasonably by not making the motorhome too warm such that people perspire, as this will only serve to generate more moist air and therefore more condensation.

However, in particularly cold periods, where the external ambient temperatures are low, condensation may still form on external walls as the insulation levels may well not be thermally able to cope with the difference between the internal and external temperatures.

How can you prevent condensation

Provide ventilation so that moist air can escape.

- a. Good ventilation of the vehicle when cooking or when drying clothes, footwear or pets is essential. Observe when windows begin to show signs of misting and increase ventilation by opening slightly by 1cm or opening a roof vent, as these will help, but keep the habitation door closed as much as possible to retain heat.
- b. If drying damp clothes or towels, open a window to ventilate the area and allow the moist air to escape.
- c. Try to make sure that the motorhome is partially heated. It can take a long time for a cold motorhome to warm up, so it is better to have a small amount of heat for a long period than a lot of heat for a short time.
- d. After showering, keep the bathroom window or skylights open, and shut the bathroom door long enough to dry off the room.
- e. In all other areas provide some ventilation. Fixed ventilation is provided in accordance with BS EN 721: 1998 this is through skylights and 'Heki roof lights' in the roofs and from ventilators through the floor under cookers, doors and in bed boxes. It is important not to block these.
- f. Electrical heating is dryer than gas heating, and introduces less moisture into the atmosphere. Do not use additional portable paraffin or flue-less gas heaters at all.
- g. If left unoccupied and unheated for long periods of time the temperatures can soak down thermally into the entire product and become very cold. Whenever possible, put the heating on at a low level before use by pre heating in cold weather.
- h. Even with reasonable ventilation it is likely if the temperature is less than 5°C and the humidity is high that condensation will occur. Ideally the temperature should be kept about 20°C when occupied.

Too much ventilation in cold weather is uncomfortable and wastes heat. All that is needed is a very slightly opened window or skylights. Opening a skylight or 'Heki; rooflights partially or windows opened to about 1cm will usually be sufficient.

Provide reasonable heating

- a. Do not use portable paraffin or flueless gas heaters at all.
- b. If drying damp clothes or towels, open a window enough to ventilate the area and turn on the electric element of the space heater but do not hang items over the heater.
- c. Try to make sure that all areas are at least partially heated. Condensation most often occurs in unheated areas.
- d. To prevent condensation, the heat has to keep room surfaces reasonably warm. It can take a long time for a cold motorhome to warm up, so it is better to have a small amount of heat for a long period than a lot of heat for a short time.

Motorhomes use only carefully selected insulation materials but unlike most rooms at home all walls are exterior walls, so they lose heat through all walls as well as the roof and floor.

Even in a well insulated motorhome with reasonable ventilation, it is likely that during cold weather (less than 10°C) condensation will occur. Ideally the temperature should be kept about 20°C although this is not always possible.

Mould Growth

Any sign of mould growth is an indication of the presence of moisture and if caused by condensation gives warning that heating or ventilation may require improving.

New vehicles

New products take a long time before they are fully 'dried out' because of the moisture in the materials used during manufacture. While this is happening extra heat and ventilation will be required.

Corrosion

Your motorhome has been designed and built using the corrosion resistant materials (e.g. GRP (Glass Reinforced Plastic) panels, stainless steel fixings, hot dip galvanised chassis and powder coated extrusions), which if looked after will extend the life and aesthetics of the product in normal service. In certain conditions, for example, if sited for extended periods in close proximity to sea and sand spray, you may experience premature ageing and/or corrosion of the vehicle than under normal conditions.

To help prevent this, we advise regular cleaning and application of a good quality external car polish. For extended periods (where the vehicle is not in use), we recommend the use of well fitted breathable vehicle cover as protection from harsh coastal elements.

10.4 Changing Exterior Bulbs**Always replace like for like.**

The road lights and awning light fitted to the coachbuilt part of your motorhome are LED and contain no user serviceable parts, in the event of a failure or damage the entire light would need to be replaced. For the road lighting on the Fiat/Ford base vehicle, please see the Fiat/Ford handbook supplied as Fiat/Ford specifications are subject to change.

10.5 Motorhome Interior Care

Follow these guidelines to ensure your investment is receiving the very best attention.

Side Walls, Roof Lining

A simple wipe over with a damp cloth and a very mild detergent is all that is needed.

Soft Furnishings

Should be vacuumed occasionally to remove grit and sand and help to keep its smart appearance over the lifetime of the upholstery. The upholstery can be cleaned with a mild, reputable upholstery cleaner. It is recommended that the curtains and pelmets are specialist cleaned only. The foam used

in cushions is manufactured to meet fire regulations. It requires time to return to its normal position after prolonged use.

Cupboard Catches

It is advisable to lubricate all cupboard catches, sliding bolts and hinges from time to time. We recommend "Ambersil 40+" this is readily available from most DIY/ Automotive spare part retailers.

Doors

In order to provide customers with the latest designs of door furniture it is possible, due to the use of natural wood, that warping may occur. This should not detract from the correct functioning of items fitted in the motorhome.

Information

During the normal travelling vehicle vibration and flexing may cause some of the furniture doors to become out of alignment.

For your convenience many hinges are adjustable.

Leather care

Leather furniture, in a normal contract and domestic environment, requires little maintenance, although obviously leather in lighter shades will need more attention.

Regular care of leather does ensure its lasting quality and some general rules for regular cleaning and maintenance are:

- Clean the leather with a soft damp cloth taking care not to soak the leather.
- For a more thorough clean, use the Bridge of Weir Leather Cleaning and Protection kit available directly from the distribution centre.
- Do not use saddle soap, wax polishes or spray polishes.
- Do not use any product or any method of cleaning not recommended by the manufacturer.
- Avoid letting any buckles, studs and zips come into direct contact with the furniture.
- Avoid drying out the leather by taking extra care where there is heating or an open fireplace.

i Note: The above cleaning instructions DO NOT apply to Nubuck Suede or any other uncoated leather.

10.6 Swift Shield Fabric (model specific)

The Swift Shield fabric fitted to some Swift Group products is a luxury stain resistant durable fabric using Aquaclean® technology. This is a revolutionary fabric treatment that allows you to clean stains using water only. This provides you with simple fabric maintenance in the minimum amount of time.

Cleaning Instructions

Aquaclean® helps to remove the majority of household stains (wine, ink, sauce, fat, mud, chocolate, cream, etc.) in three simple steps:

Remove any excess residue on the upholstery.



Apply water over the stain, either directly or using a damp cloth. Wait a few seconds.



Press down over the stain with a damp cloth and rub gently over the fabric in circular movements. If the stain does not come off completely, repeat the process as required.

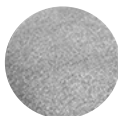

For further details and stain cleaning demo videos visit the Cleaning Gallery on the Aquaclean® web site: http://www.aquaclean.com/ES_en/home.

Aquaclean fabrics cannot accept any responsibility for misuse of the fabric by allowing bleach or dissolvent substances coming into contact with it.

Stainless Steel Bowl Care Instructions

After use always remove any plastic bowl or mat, rinse down the surface and dry with a soft cloth to prevent spotting. For more stubborn dirt or grease a non-abrasive multi-purpose cream cleaner, such as CIF, may be used. To preserve the appearance of your appliance we recommend plastic bowls or mats are not stored in the sink during transit.

The quality of water can affect your bowl's appearance. If the water has high iron content, a brown surface stain can form on the bowl giving the appearance of rust. Additionally, in areas with a high concentration of minerals, or with over-softened water, a white film may develop on the sink. To combat these problems, towel dry the sink after use, and clean at least once every week.

Surface scratching will be most noticeable on highly polished components. These marks are usually only superficial and can be removed with a proprietary stainless steel cleaner/polish. If the surface has a directional polished grain always clean along the grain and NOT across. Never use wire wool pads to clean the surface.

Cleaning agents containing bleach should NOT be left in contact with stainless steel. This includes many of the new "trigger-dispense" products and some multi purpose cream cleaners. Also leaving rubber mats or dishpans in the sink can lead to surface rust or pitting, always remove them after use.

Work Surfaces

You should not stand very hot items on any of the work surfaces, especially models with polycarbonate moulded sinks and drainers.

Kitchen Equipment

All the thermoplastic parts in these areas have easy clean surfaces. To ensure long life and to prevent damage you must not use any cleaning materials at all and ensure water temperatures do not exceed 70°C (putting cold water in first is suggested). After every use it is essential that you rinse with clean water only and wipe with a soft damp cloth. Failure to follow these simple instructions may result in premature failure or cracking which will not be covered by any guarantees (including extended warranties).

Bathroom/Shower

These products should be cleaned immediately after use. Apply a warm, mild soapy water solution with a soft cloth and rinse with clean water immediately. Abrasive materials must never be used.

Washroom bi-fold doors

- Panels should be cleaned with warm soapy water and a non-abrasive cloth/sponge.
- An abrasive or aggressive cleaning agent is never to be used
- A proprietary plastic cleaner Vuplex®, can also be used. This can be obtained from outlets such as Amazon, ebay etc.

Furniture

A simple wipe over with a damp cloth should be all that is required. Polishing with a proprietary brand of wax polish enhances and maintains furniture in showroom condition.

Kitchen Drainer and Cutting Board

You should not stand hot items on to the removable plastic kitchen drainer. To wash use only warm soapy water, do not use chemicals and bleach.

Changing interior bulbs / LED Lights

For non LED lights remove the lens or lampshade to access the bulb.

Always replace like for like

10.7 LED Replacement

In many applications LED lights are fitted which contain no user serviceable parts. In the unlikely event of failure of one of these lamps, the entire lamp will need to be replaced – several types of LED light are intended for semi-permanent installations using self adhesive mounts etc, and dealer assistance may be required should damage or other need for replacement occur.

10.8 Winterisation

The Swift Group recommends the following winterisation points for customers:

Servicing

Arrange (in advance) the yearly service and habitation check, if the motorhome's next service is due while the vehicle is stored.

Plumbing

Water expands as it is frozen, and so trapped water, when it expands, can damage the tap / valve / pump or pipe it is trapped within. For this reason, (in addition to reasons of hygiene), the water system should be fully drained when not in use, particularly in colder weather.

- Open both the fresh tank and waste water tank drain valves (via the control panel above the entrance door, the switches in the China Locker or by the manual valve under the skirt (Edge and Voyager) or remove the bung in the bottom of the fresh tank (Edge).
- Open the drain valve (yellow handle) next to water heater, and leave open. See section 7.2.
- Fully open all the taps and shower mixer, move mixer position to the middle, and leave all taps in the open position.
- Unscrew the shower head and shower hose, shake out remaining water and allow water to drain. It is advised to leave the shower head and hose disconnected.
- Run pump for a short time, until all water is expelled.
- After a short while the majority of water will have left the plumbing system. At this point however it is still important to ensure that the pump itself is 'dry'. During this part of the winterisation, a suitable absorbent cloth or container should be used to catch a small amount of spilled water that will result.

Disconnect the pipe work from the pump by pulling the blue quick release tabs, at either side of the pump, at right angles to the pipe work, then pulling the pipe and connectors from the pump. See Fig.1 Run the pump for a short while to expel any remaining water within the pump.

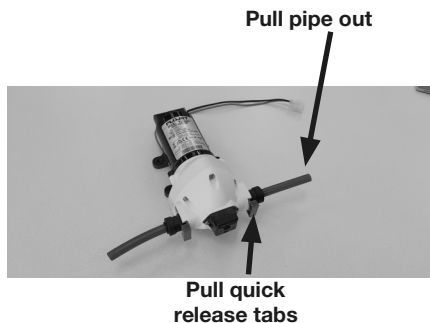

Fig.1

Electrical

If vehicle is being stored while connected to 230v Mains Hook-up:

- Ensure that the leisure battery is connected, and the leisure battery fuse or fuses are in place.
- The isolator switch on PSU should be in the 'ON' position, however, the control panel should be switched 'OFF'.
- If Alde system is installed, there is a frost protection setting, which can be used. See Alde user instruction manual.
- Vehicles can be left in this condition for extended periods, with the charger operating to maintain the battery. However, periodic maintenance and inspection is recommended, this should include the battery condition.

If vehicle is being stored not connected to 230v Mains Hook-up:

- Charge the leisure battery for 24 hours prior to placing motorhome in storage.
- Ensure the isolation button on PSU is in the 'OFF' position.
- The battery should not be adversely affected by winter temperatures but the level of charge should be maintained to maximise the life span of the battery. This can be achieved using an automotive type battery charger as and when required.
- Disconnect the vehicle battery negative terminal. Check the charge of the battery every three months. (See Vehicle Inactivity section in the Fiat handbook). Alternatively put the ignition into the 'Isolation Mode'

⚠ WARNING: If your motorhome is fitted with Swift Command Tracker (by Sargent) which monitors battery voltage. If you plan to disconnect or remove your leisure battery for maintenance or external charging, then please contact the monitoring station before you remove or disconnect the battery. If a leisure battery is not fitted, please also contact the Tracker monitoring station before removing the mains hook up. The Swift Command Tracker monitoring station can be contacted on 0345 6027302 Gas system.

Gas system

- Ensure the gas supply is isolated at the gas bottle, and ensure that the gas manifold taps are off.
- Check the age and condition of the high pressure gas hose and regulator, and replace if required.

Appliances

Check the battery expiry date on the smoke alarm and CO detector and replace or remove as required.

- Ensure the fridge is turned off.
- Clean the inside of the fridge.
- Prop the fridge door open, and if possible, the internal freezer compartment door for ventilation.
- Fit fridge vent winter covers (if available).
- Ensure all hob / oven / microwave surfaces are clean.
- If the motorhome is going to be left connected to 230v supply while not in use, ensure the microwave is unplugged.
- Clean the toilet and empty the cassette and lubricate the seals with an acid free lubricant such as Thetford High Grade Seal Lubricant. See Thetford toilet Users manual.

Exterior (Body / Chassis)

- Ensure that all windows, skylights and access doors are closed and secured.
- Ensure all fixed ventilation points (high and low) are clear from debris and obstructions.
- Ensure the vehicle is not parked where falling debris (i.e. leaves, tree sap) could cause damage.
- Avoid leaving the vehicle parked in soft ground, long grass or a potential area where standing water may form.
- Lubricate relevant points on the chassis.

Wheels and Tyres

- Do not store in one position with partially deflated tyres. The tyre walls will suffer and do present a real danger of blow outs, especially when travelling at faster speeds than are allowed in the UK. The wheels should be turned every couple of weeks. If you are removing the wheels, follow the jacking procedure for changing a wheel. Check your tyres regularly for signs of age and deterioration, particularly wear, cracking and blistering. If in doubt consult a reputable tyre fitter.
- A purpose made cover maybe used, but please ensure the cover is a good fit, breathable and securely fitted.

Note: A poorly fitted cover can rub and damage the bodywork. Non-breathable covers will encourage mould to grow.

Interior (Furniture / furnishings)

- Open all lockers and internal doors, to ensure good circulation.
- Remove cushions and store them in a dry location or ensure all cushions are placed in a well ventilated area.
- Close all blinds and curtains. Customers are reminded to check the tension on blinds after storage if left closed for long periods.
- Thoroughly ventilate the motorhome by opening doors or windows periodically.
- Placing water absorbent crystals in the van during the winter months, will help reduce moisture levels and mould growth.
- We do not recommend leaving portable heaters in the van unattended.

Recommissioning the water system

Re-connect the water pump by positioning the pipe connectors into the pump housing and pushing the blue tabs into position. it is advisable, after a period of non-use, to flush the water system with a sterilising solution suitable for stainless steel containers and components. Fill the fresh water tank with water and sterilising fluid (refer to sterilising fluid instructions for the amount to use). Turn the pump on and open all the taps, ensuring that the water drains away safely to the waste tank.

When the waste tank is full empty the fluid into a designated waste water area. Re-fill the tank with fresh water and flush through the system

as described above; repeat this until all traces of the sterilising fluid have been flushed out. (See sections 7.3, 7.4 and 7.6)

Prepare the toilet system by adding water and Thetford fluid to the toilet waste tank. (See section 9.11)

Appliances

Before starting motor caravanning after storage, check all gas appliances and electrical points.

Note: Preferably not less than once a year, the electrical installation should be inspected and tested by a qualified electrician.

After storage it is advisable to air the Motorhome and clean throughout, especially cooking appliances and the refrigerator.

Replace the bedding if they were removed for storage.

WARNING: Always follow the manufacturers recommended procedures after use of fitted equipment in the Motorhome, before storing for any length of time.

10.9 Chassis and rear axle

Some models are built on a Fiat base vehicle, the chassis of which has been converted by AL-KO. This conversion provides a hot dipped galvanised steel chassis coupled with a wide track rear axle utilising steel torsion bar suspension, imparting vastly improved stability and road holding.

10.10 AL-KO exhaust system

A standard Fiat exhaust system is fitted, utilising an AL-KO modified tail pipe, available through your approved dealer. A standard Fiat/Ford exhaust system is fitted to all other models, with the addition of a Swift Group tail pipe.

10.11 Caring for the environment

After many years of service you may decide that your motorhome has become beyond economic repair and should be disposed of. Please ensure that you comply with the end of life vehicle legislation and take it to an authorised treatment facility where it will be properly dealt with to minimise any negative environmental impact. The transaction will be logged at the DVLA, identifying that you are no longer the owner of the vehicle.

11. Useful Information

11.1 Owners club	194
11.2 Spares and after sales customer service	194
11.3 Repair facilities	194
11.4 Caravan Clubs	195
11.5 Motoring Associations	195
11.6 Trade Association	195
11.7 Index	161
11.8 Change of ownership	200

11.1 Owners club

The Owners Club is a completely independent organisation run for the benefit of the motorhome owners. They have numerous rallies during the year in various parts of the country. Apart from the friendliness and companionship the Club generates it is also actively engaged in charity work for those less fortunate than ourselves. The address of the Secretary of the Owners Club can be obtained from the Swift Group website.

11.2 Spares and after sales customer service

A catalogue of spare parts are available through our Swift Group Dealer Network, from door catches through to spare wheels. Please note, all parts enquiries must be directed through your dealer, as the Swift Group does not operate a direct retail service.

We endeavour to supply parts for vehicles up to 8 years old. If the original part is no longer available your dealer should be able to source a suitable alternative.

Note: Please remember to quote chassis VIN (Vehicle Identification Number) when ordering any items from your dealer. This can be found at the bottom of the windscreen, on the Swift and Ford plates on the passenger cab door B pillar or on the Fiat plate on front cross member within the engine compartment.

11.3 Repair facilities

Should you be unfortunate to encounter damage to your vehicle, we have a number of approved workshops and dealerships with workshop facilities to undertake such repairs.

Details of which can be found via our website: www.swiftgroup.co.uk/find-a-dealer



The enjoyment of motorhoming can be greatly enhanced by membership of one or more of the various motorhome/caravanning, motoring and holiday clubs. Here are some useful addresses:

11.4 Caravan Clubs

The Caravan Club,

East Grinstead House, East Grinstead
West Sussex, RH19 IUA
Tel: 01342 326944
www.caravanclub.co.uk

The Camping and Caravanning Club,

Greenfields House,
Westwood Way,
Coventry,
West Midlands.
Tel: 0845 130 7631 or 024 7647 5448
www.campingandcaravanningclub.co.uk

11.5 Motoring Associations

Automobile Association (AA)

Fanum House,
Basingstoke,
Hants. RG1 2EA
Tel: 08705 448866
www.theaa.co.uk
e-mail: customer.services@theaa.com

RAC Motoring Services

RAC Motoring Services
8 Surrey St
Norwich Norfolk NR1 3NG
Tel: 01922 437000
www.rac.co.uk

The Society of Motor Manufacturers and Traders Limited (SMMT)

Forbes House,
Halkin Street,
London SW1X 7DS
Tel: 020 7235 7000
www.smmt.co.uk

Green Flag

Tel: 0845 246 1557
www.greenflag.com

RBS Insurance

Churchill Court
Westmoreland Road
Bromley
Kent BR1 1DP
Tel: 0800 158 2493

11.6 Trade Association

NCC

Catherine House,
Victoria Road,
Aldershot,
Hampshire, GU11 1SS
Tel: 01252 318251
www.thencc.org.uk
www.motorhomeinfo.co.uk
e-mail: info@thencc.org.uk

Index

Symbols

12 Volt DC Fuses	81, 104
230V mains electrical equipment power consumption	66
3030 Alde Heating System	130

A

Accessory harnessing	116
AC Current Limiter Operation	94
Acrylic (Plastic) Window Cleaning	142
Additional security	42
Advice on towing	28
Aguti Smart Lounge (Escape, Voyager and Kon-Tiki)	155
Airbag	24
Air-conditioning	97
Alarm Power Supply	116
Alde 3030 Control Panel and Appliance Instructions	130
Alde Compact 3030 Boiler	130
Alde Zonal Control	131
AL-KO exhaust system	171
All roof windows and Skyviews	145
Annual service/ inspection record	10
Ascarri Hob and Oven	138
Awnings and Tents	17, 46
Awning Spaces LPG Appliance Exhaust	62

B

Base Vehicle Warranty	6
Bathroom/Shower	168
Battery Charger	78, 102
Battery replacement	112
Before moving off	20
Blind Advice	144
Body Shell Warranty	6, 7, 9
Boiler / Water System Drain	49
Bottle Replacement Procedure	37
Bunk and luton bed safety	156
Butane	60
Butterfly outlets	125

C

Cab Radios	160
Camp sites	16
Caravan Clubs	175
Care of laminate tops, tables, furniture and doors	159
Care of the microwave	140
Caring for the environment	171
Cassette Toilet Faults	141
Central locking	20
Change of ownership	9, 180
Changing a gas cylinder	61
Changing Exterior Bulbs	166
Changing interior bulbs / LED Lights	168
Charging from Solar Panels	115
Chassis and rear axle	171
Children	40
Child seats	23
Cleaning water system	51
CO alarm	41
Coastal code	18
Code of conduct	16
Combi 4 Gas/Electric and Combi 6 Gas/ Electric appliances	126
Common Fault Table	82, 105
Condensation	164
Connecting to the Mains 230V supply and Safety checks	71, 88
Conventional Load	21
Cooker 3 burner with combined grill and oven / cooker 3 burner + electric hotplate with separate grill and oven	132
Cooking Guidelines	135
Corrosion	166
CP Plus Controller	126
Cruise control	33
Cupboard Catches	166
Cycle racks	154
Cylinder compartment	60

D

Dedicated travelling passenger seating	23
Dogs and other Pets	16
Dometic absorption refrigerator	131

Doors	167	Furniture	168
Driving	17	G	
Driving licence	28	Gas	59
E		Gas Cylinders	59
EC400 + Control Panel Component Layout ..	72	Gas fault finding	64
EC400+ Motorhome Power Control System	70	Gas Hoses	59
EC800 Air-conditioning screen	97	Gas Operation	137
EC800 Bluetooth Pairing & Other Controls ..	97	Gas safety advice	62
EC800 Control Panel	89	Generator usage	117
EC800 Heating Controls	95	Generator Usage	78, 101
EC800 Power screen (230V)	94	H	
EC800 Refrigerator Controls	96	Habitation relay	117
EC800 Water Tank Screen	92	Handbooks (chassis & converter)	18
Electrical Operation of Alde 3030 Heating System	130	Heated seats	155
Electrical Operation of Truma Combination Boiler	126	Height-based seats	24
Electric Step Operation	76, 98	Horrex Window Blinds	143
En-route heating	61	How can you prevent condensation	165
Environment	17	I	
Escape, Ascari and Voyager cab roof window	145	Inflation Procedure	36
Escape paths	40	Interior (Furniture / furnishings)	171
Essential Habitation	21	ISOFix Child Seat Restraint	25
European Touring	29	K	
Event of a Theft	42	Kitchen Drainer and Cutting Board	168
Extended Body Shell Warranty	6, 7	Kitchen Equipment	168
External 12v Fill Socket	50	Kon-Tiki Thetford K1520	137
F		L	
Factory fitted Solar Energy System	115	Large storage areas	22
Facts about LPG	62	Leaks	136
Fault Finding	118	Leather care	167
Fiat Based Motorhome Tyre Specifications	23	LED Replacement	168
Fiat Fix & Go Repair Kit	35	Leisure Battery	79, 102
Fiat handbook	18	Levelling the motorhome	46
Fire	40	Lighting & Dimming Operation	93
Fire Extinguisher	40	Lippert Rise and Fall Island Bed (Kon-Tiki)	157
Fire Precautions	16	Loading of vehicle	21
Ford handbook	18	M	
Fresh water system	49	Maintenance & servicing	136
Fresh Water Tank	50	Mapa Electric Telescopic Table leg	158
Frost Protection Operation	75		

Mass in Running Order	20	Power Supply Unit - Component Layout ..	71, 88
Maximum Technically Permissible Laden Mass	21	Pressure switch	52
Maximum User Payload	21	Pressure switch adjustment	52
Microwave owner general user instructions	138	Priming the Water System	50
Midi Heki	147	Propane	60
Mini and Micro Heki rooflight	146	Provide reasonable heating	166
Motorhome battery	111	R	
Motorhome exterior	164	Recomissioning the water system	171
Motorhome Interior Care	166	Remote Access & Control	108
Motorhome National Speed Limits	32	Removal of Fiat spare wheel	34
Motorhomes with external barbeque point	59	Removal of spare wheel on ALKO conversion	33
Motorhomes with external BBQ point	161	Repair facilities	174
Motorhome terms	20	Replacement parts	108
Motorhome theft	41	Residual Current Device & Miniature Circuit Breakers	101
Motorhome Warranty	6	Reverse Camera System	153
Motorhome Water Tank Drains	49	Roof lights	145
Motorhome Wifi (where fitted)	160	Roof loading	22
Motoring Associations	175	S	
Mould Growth	166	Sanitising	51
MPK Rooflight	148	Satellite Power Supply	116
My Swift Life	9	Seat belts and legislation	23
N		Seat swivel (Driver/Passenger)	155
National Speed Limits	32	Security	41
Noise	16	Seitz Window Systems	142
Nose weight of Towed Trailers	21	Selecting a pitch	46
O		Sensor cleaning	54
Omni step single step	151	Separate Water Containers	51
Omni-vent	150	Servicing	169
Optional Equipment	21	Shower	161
Oven Temperature Control	135	Side lockers	155
Owners club	174	Side Walls, Roof Lining	166
P		Single lens camera system	153
Parking	17	Skyview operating instructions	144
Parking sensors	33	Smart Charging	76
Personal Effects	21	Smoke Alarm Operation	40
Plastoform Window System	142	Soft Furnishings	166
Plumbing	169	Solar Charge Management	75, 93
Positioning the motorhome	46	Solar panel connection point or Solar panel	
Powered Bed Mechanism (model specific)			

fitment	115	Tyres	22
Spares and after sales customer service	174	Tyre Sealant and Inflator Kit	37
Stainless Steel Bowl Care Instructions ..	168		
Status 570 Digital antenna system	159	U	
Sterilising	51, 52	Use of cameras	153
SuperSure Warranty	6, 7, 8	Use of Site Appliances	16
Supplier contacts	13	Using the Grill	134
Swift Command App	108	Using the Hotplate Gas Burners	132
Swift Command Power Control System	87	Using the Oven	135
Swift Command SIM Coverage & Usage information	108	V	
Swift Command Tracker by Sargent	42	Vehicle modifications & non-standard parts	164
Swift Command Web usage & Description	108	Vehicle Movement	16
Swift Shield Fabric (model specific)	167	Ventilation	41
System Technical Information	101	VIN CHIP identification	43
System Warnings	74, 99	VIN CHIP™	43
		VIN (Vehicle Identification Number)	41
T		W	
Tables	158	Washroom bi-fold doors	168
Table storage	158	Waste Disposal	16
Tank heaters	53	Waste water system	53
Technical Data	85	Water fault finding	55
Technical Data & Approvals	109	Water level sensor & cleaning	54
Temperature Readings	91	Water system	48
The Country Code	17	Water System Operation	75, 91
The electrical system	65	Water Tank Heaters	92
Thermal insulation heating	63	Weight-based seats	24
Thetford Toilet	140	What to do if you require assistance	9
Thetford Triplex Cooker	132	Wheels and Tyres	171
Three point seat belts	27	Wild camping	17
Thule T4200 / 8000 Omnistor Awning	151	Window Friction Stays	142
Tow Bar Connection	116	Windows	142
Trade Association	175	Winterisation	169
Truma Combination Boiler	124	Work Surfaces	168
Truma Combination Boiler Control Panel and Appliance Instructions	125		
Truma Heating System and Air Flow	125		
TV Brackets	160		
TV inlet	159		
Twin lens camera system	153		
Types of gas	60		
Tyre Pressures	23		



All Swift Group models have been certified by the NCC for compliance with stringent European Standards, British Legislation and industry SET Codes of Practice specifically relating to health and safety issues.

The approval process covers the testing and inspection of critical areas of the product from fire safety, weights and dimensions, to gas, electrics and ventilation. Every motorhome carries the "NCC Approved Motorhome" badge.

The NCC also conduct unannounced inspections at the Swift factory to ensure continued compliance. NCC Approval gives you peace of mind that your motorhome is legal and safe.

All Swift Group motorhomes are UK and European Whole Vehicle Type Approved.

This is your assurance that these motorhomes meet all European regulations, and have been constructed and conform to approved safety, environmental and manufacturing control standards.

11.8 Change of ownership

Notification of change of ownership

As the new second hand owner, please notify the Swift Group of the change of ownership by emailing your details to enquiries@swiftleisure.co.uk, please also provide a telephone number, date of purchase and a copy of your V5 document. We will confirm that you records have been updated via an email and you will be invited to join the "My Swift Life" portal, which will enable you to access your vehicle details.

If you do not have access to email, you can complete the form below and send the completed form with a copy of your V5 to the following address:

Customer Services
Swift Group Limited,
Dunswell Road,
Cottingham,
East Yorkshire,
HU16 4JX.

Note: Warranties are only transferable providing the terms and conditions of the warranty have been met by the previous owner(s). Please see warranty information at the beginning of this handbook for full details. The 'Extended Body shell warranty' is a non-transferable warranty.

Details of motorhome:	Model:	
	Chassis No:	
New owner:	Name:	
	Address:	
	Email:	
	Telephone:	
	Mobile:	
	Date of purchase:	
Previous Name: owner:	Name:	
	Address:	
	Email:	
	Telephone:	
	Mobile:	
	Date of purchase:	



SWIFT

SWIFT GROUP

Dunswell Road

Cottingham

East Yorkshire

HU16 4JX

Tel: 01482 875740

Fax: 01482 840082

Customer Experience Team

enquiries@swiftleisure.co.uk

FIND OUT MORE AT **SWIFTGROUP.CO.UK**